

**REPUBLIC OF TURKEY  
HACETTEPE UNIVERSITY  
INSTITUTE OF HEALTH SCIENCES**

**ANALYSIS OF OXYSTEROL SPECIES  
IN TYPE 1 AND TYPE 2 DIABETES MELLITUS BY LC-MS/MS  
METHOD**

**Afshin SAMADI**

**BIOCHEMISTRY PROGRAM**

**PhD THESIS**

**ANKARA**

**2016**

**REPUBLIC OF TURKEY  
HACETTEPE UNIVERSITY  
INSTITUTE OF HEALTH SCIENCES**

**ANALYSIS OF OXYSTEROL SPECIES  
IN TYPE 1 AND TYPE 2 DIABETES MELLITUS BY LC-MS/MS  
METHOD**

**Afshin SAMADI**




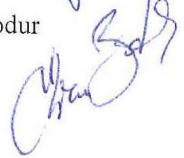
**BIOCHEMISTRY PROGRAM  
PhD THESIS**

**MENTOR  
Assoc. Prof. Dr. Incilay Lay**

**ANKARA  
2016**


**ANALYSIS OF OXYSTEROL SPECIES  
IN TYPE 1 AND TYPE 2 DIABETES MELLITUS BY LC-MS/MS METHOD  
Afshin Samadi**

This study has been approved and accepted as a PhD dissertation in the program of "Biochemistry" by the examining committee, whose members are listed below, on 23.12.2016

<b>Chairman of the Committee :</b>	Prof.Dr. Neslihan Celik Bukan  (Gazi U.F.M)
<b>Advisor of the Dissertation :</b>	Assoc.Prof. Dr. Incilay Lay  (Hacettepe U.F.M)
<b>Member :</b>	Prof.Dr.Ayşe Kevser Ozden  (Hacettepe U.F.M)
<b>Member :</b>	Prof.Dr.Erdinc Devrim  (Ankara U.F.M)
<b>Member :</b>	Assoc.Prof. Dr.Ebru Bodur  (Hacettepe U.F.M)

**APPROVAL**

This dissertation has been approved by the committee above in conformity to the regulations and by laws of Hacettepe University Graduate Programs and has been accepted by the Board of Directors of the Institute of Health Sciences.

  
Prof. Dr. Diclehan Orhan  
Institute Director

## YAYIMLAMA VE FİKRİ MÜLKİYET HAKLARI BEYANI

Enstitü tarafından onaylanan lisansüstü tezimin/raporumun tamamını veya herhangi bir kısmını, basılı (kağıt) ve elektronik formatta arşivleme ve aşağıda verilen koşullarla kullanıma açma iznini Hacettepe Üniversitesine verdiğimi bildiririm. Bu izinle Üniversiteye verilen kullanım hakları dışındaki tüm fikri mülkiyet haklarım bende kalacak, tezimin tamamının ya da bir bölümünün gelecekteki çalışmalarda (makale, kitap, lisans ve patent vb.) kullanım hakları bana ait olacaktır.

Tezin kendi orijinal çalışmam olduğunu, başkalarının haklarını ihlal etmediğimi ve tezimin tek yetkili sahibi olduğumu beyan ve taahhüt ederim. Tezimde yer alan telif hakkı bulunan ve sahiplerinden yazılı izin alınarak kullanılması zorunlu metinlerin yazılı izin alınarak kullandığımı ve istenildiğinde suretlerini Üniversiteye teslim etmeyi taahhüt ederim.

**o Tezimin/Raporumun tamamı dünya çapında erişime açılabilir ve bir kısmı veya tamamının fotokopisi alınabilir.**

(Bu seçenekle teziniz arama motorlarında indekslenebilecek, daha sonra tezinizin erişim statüsünün değiştirilmesini talep etmeniz ve kütüphane bu talebinizi yerine getirirse bile, teziniz arama motorlarının önbelleklerinde kalmaya devam edebilecektir)

**● Tezimin/Raporumun 23.12.2018 tarihine kadar erişime açılmasını ve fotokopi alınmasını (İç kapak, Özet, İçindekiler ve Kaynakça hariç) istemiyorum.**

(Bu sürenin sonunda uzatma için başvuruda bulunmadığım takdirde, tezimin/raporumun tamamı her yerden erişime açılabilir, kaynak gösterilmek şartıyla bir kısmı veya tamamının fotokopisi alınabilir)

**o Tezimin/Raporumun.....tarihine kadar erişime açılmasını istemiyorum ancak kaynak gösterilmek şartıyla bir kısmı veya tamamının fotokopisinin alınmasını onaylıyorum.**

**o Serbest Seçenek/Yazarın Seçimi**

23/12/2016

**Afshin Samadi**

## **ETHICAL DECLARATION**

In this thesis study, I declare that all the information and documents have been obtained in the base of the academic rules and all audio-visual and written information and results have been presented according to the rules of scientific ethics. I did not do any distortion in data set. In case of using other works, related studies have been fully cited in accordance with the scientific standards. I also declare that my thesis study is original except cited references. It was produced by myself in consultation with supervisor Assoc. Prof. Dr. Incilay Lay and written according to the rules of thesis writing of Hacettepe University Institute of Health Sciences.

**Afshin Samadi**



## ACKNOWLEDGMENT

I wish to express my first and foremost gratitude to my advisor Assoc. Prof. Dr. Incilay Lay for giving me the opportunity to work in her group and providing me endless guidance and support from the beginning. I have learnt a lot from her experiences and wisdom throughout this period. Her positive attitude has always motivated me even in tough times. It is hard to explain my feeling about her. It is always good to trust her and know that she always stay right behind me in any ways. She always had been more than an advisor. She had been a mother, a sister and even a best friend sometimes. She always showed patience and never-ending assistance as being an advisor.

I would like to present my appreciation to her for her tremendous contribution to my both academic and personal life with her scientific and social advices. She has always been there when I need her. I am very grateful and indebted to her for her inestimable guidance. It was a privilege for me to work with her. I would like to present my appreciation to our department president Prof. Dr. N. Leyla Acan. I also wish to show my appreciation and gratitude to my previous advisor Prof. Dr. N. Nuray Ulusu.

I would like to thank Prof. Dr. Alper Gurlek and his fellow Dr. Suleyman Nahit Sendur for providing diabetic patients samples to me. In addition, I would like to present my acknowledgment to all past and present professors and faculty members of Hacettepe University, Faculty of Medicine, Department of Medical Biochemistry and Clinical Pathology Laboratory for their guiding principles, which helped me to find my direction in my academic career.

I would like to thank my committee members, Prof. Dr. Erdinc Devrim, Prof. Dr. Neslihan Celik Bukan, Prof. Dr. Ayse Kevser Ozden, Assoc.Prof. Dr. Incilay Lay, and Assoc. Prof. Dr. Ebru Bodur, for their support and comments on my thesis to improve and extend it. I would like to dedicate this dissertation to my parents Bizhan Samadi, Fariba Esmali Moghadam and my dear sister Dr. Mahshid Samadi. Their endless, unconditional love, unlimited support, and patience were always with me. I could not have achieved this without them. Thank you for being with me in every decision I make throughout my life.

## ABSTRACT

**Samadi, A. Analysis of oxysterol species in type 1 and type 2 Diabetes Mellitus by LC-MS/MS method. Hacettepe University Institute of Health Sciences, Ph.D. Thesis in Biochemistry, Ankara, 2016.** Oxidative stress plays an important role in the pathophysiology of diabetes mellitus (DM). Oxysterols, which resulted from spontaneous or enzymatic oxidation of cholesterol, are potentially non-invasive biomarkers of oxidative stress in vivo. The aim of the present study was to evaluate oxysterol species (7-ketocholesterol and cholestan-3 $\beta$ ,5 $\alpha$ ,6 $\beta$ -triol) as biomarkers of oxidative stress in diabetic patients. 7-ketocholesterol and were quantified by using a reliable, sensitive and specific LC-MS/MS method in type 1 (n=26) and type 2 (n=80) DM patients as well as in healthy controls (n=205). The correlation between oxysterols and clinical/biochemical characteristics of the DM patients were also determined. Plasma 7-ketocholesterol levels in type 1 DM (42.75 $\pm$ 11.54 ng/mL) and more clearly in type 2 DM (84.80 $\pm$ 43.71 ng/mL) patients were significantly higher than those in control subjects (18.97 $\pm$ 3.83 ng/mL) (p<0,001). Type 1 and more significantly type 2 DM patients also demonstrated high levels of (32.30 $\pm$ 8.93 ng/mL and 65.69 $\pm$ 35.34 ng/mL) compared to healthy controls (10.106 $\pm$ 3.94 ng/mL) (p<0,001). Positive correlations of oxysterol levels with glucose, HbA1c, serum total cholesterol, LDL, VLDL, triglyceride, number of risk factors and BMI were observed (p<0,001). Strong significant relations between oxysterols and microvascular complications as well as usage of drugs were determined. In conclusion, plasma oxysterol levels in DM, particularly in type 2 diabetic patients, may yield complementary information in oxidative stress. Oxidative stress is likely a causative factor in the development of insulin resistance. Furthermore, our LC-MS/MS method for determining oxysterols is the only study in diabetic patients so far. It is more sensitive and reliable method when compared to GC-MS method. More effort is needed to establish the clinical utility of oxysterols as sensitive biomarkers of oxidative stress to foresee and monitor the potential complications of DM. **Key Words:** Oxysterols, Diabetes Mellitus, 7-ketocholesterol, Cholestan-3 $\beta$ ,5 $\alpha$ ,6 $\beta$ -triol, LC-MS/MS, Oxidative stress.

## ÖZET

**Samadi, A. Tip 1 ve Tip 2 Diabetes Mellitusta oksisterol türlerinin LC-MS/MS yöntemi ile incelenmesi. Hacettepe Üniversitesi Sağlık Bilimleri Enstitüsü, Biyokimya Doktora Tezi, Ankara, 2016.** Oksidatif stres, diabetes mellitusun (DM) patofizyolojisinde önemli rol oynamaktadır. Kolesterolün spontan veya enzimatik oksidasyonundan kaynaklanan oksisteroller, oksidatif stresin invazif olmayan potansiyel biyobelirteçleridir. Bu çalışmanın amacı diyabetik hastalarda oksidatif stresin biyobelirteçleri olarak oksisterol türlerini (7-ketokolesterol ve cholestan-3 $\beta$ , 5 $\alpha$ , 6 $\beta$ -triol) değerlendirmektir. Plasma 7-ketokolesterol ve kolestan-3 $\beta$ , 5 $\alpha$ , 6 $\beta$ -triol düzeyleri tip 1 (n = 26), tip 2 (n = 80) DM hastalarında ve sağlıklı kontrollerde (n=205) güvenilir, duyarlı ve spesifik LC-MS/MS yöntemi kullanılarak kantite edildi. Oksisteroller ile diyabetik hastaların klinik/biyokimyasal özellikleri arasında korelasyonlar belirlendi. Tip 1 DM ( $42.75 \pm 11.54$  ng/mL) ve belirgin olarak tip 2 DM ( $84.80 \pm 43.71$  ng/mL) hastalarında plazma 7-ketokolesterol düzeyleri, kontrol grubuna göre ( $18.97 \pm 3.83$  ng/mL) anlamlı derecede yüksek bulundu ( $p < 0.001$ ). Tip 1 ve belirgin şekilde tip 2 DM hastalarında, sağlıklı kontrollere ( $10.106 \pm 3.94$  ng/mL) göre yüksek kolestan-3 $\beta$ , 5 $\alpha$ , 6 $\beta$  triol ( $32.30 \pm 8.93$  ng/mL ve  $65.69 \pm 35.34$  ng/mL) değerleri saptandı ( $p < 0,001$ ). Plazma oksisterol düzeyleri ile HbA1c, serum total kolesterol, LDL, VLDL, trigliserit, risk faktörlerinin sayısı ve VKİ düzeyleri arasında pozitif korelasyon tespit edildi ( $p < 0,001$ ). Oksisteroller ile mikrovasküler komplikasyonlar ve ilaç kullanımı arasında güçlü anlamlı bir korelasyon saptandı. Sonuç olarak, DM'da, özellikle tip 2 diyabetik hastalarda, plazma oksisterol düzeyleri ölçümü oksidatif stres hakkında önemli bilgi verebilir. Oksidatif stresin, insülin direnci gelişiminde nedensel bir faktör olduğu söylenebilir. Diyabetik hastalarda oksisterollerin belirlenmesinde kullandığımız LC-MS/MS yöntemi literatürde günümüze kadar bilinen tek araştırmadır. GC-MS yöntemi ile karşılaştırıldığında daha duyarlı ve güvenilir bir yöntemdir. DM'da potansiyel komplikasyonları öngörmede ve izlemede, oksidatif stresin hassas biyobiyobelirteçleri olarak oksisterollerin klinik kullanımı konusunda daha çok bilimsel araştırmalara ihtiyaç vardır. **Anahtar Kelimeler:** Oksisteroller, Diabetes Mellitus, 7-ketokolesterol, Cholestan-3 $\beta$ , 5 $\alpha$ , 6 $\beta$ -triol, LC-MS/MS, Oksidatif stres.



## TABLE OF CONTENTS

	Page
Approval page	
Acknowledgement	vi
Abstract	vii
Özet	viii
Table of Contents	ix
Abbreviations	xi
List of Figures	xiii
List of Tables	xv
<b>1. INTRODUCTION</b>	<b>1</b>
<b>2. GENERAL INFORMATION</b>	<b>2</b>
2.1. Diabetes Mellitus	2
2.1.1. History of Diabetes Mellitus	2
2.1.2. Diabetes Mellitus Definition	3
2.1.3. Clinical Signs and Symptoms	4
2.1.4. Diabetes Mellitus Diagnostic Criteria	5
2.1.5. Diabetes Mellitus Clinical Stages	6
2.1.6. Classification of Diabetes Mellitus	7
2.1.7. Diabetes Mellitus Type 2	14
2.1.8. Gestational Diabetes Mellitus (GDM)	18
2.2. Diabetes Mellitus and Oxidative Stress	19
2.3. Oxysterols	21
2.3.1. Formation of Oxysterols	23
2.3.2. Cellular and Blood Levels, Metabolism and Elimination of Oxysterols	29
2.3.3. Physiological Activities and Biological Roles of Oxysterols	31
2.3.4. Methods for Oxysterol Analysis	35
2.4. Liquid chromatography-Tandem mass spectrometry (LC-MS/MS)	37
2.4.1. The Mechanism of Electrospray Ionization	38
2.4.2. Mass Spectrometry	40

<b>3. Materials and Methods</b>	44
3.1. Chemicals	44
3.2. Equipment and Instruments	45
3.3. Study Groups	45
3.4. Sample Collection	46
3.5. Measurement of Biochemistry Profiles	46
3.6. Oxysterol Analysis	46
3.6.1. Optimization of Chromatographic Conditions and Mobile Phase Gradient	47
3.6.2. Preparation of Solutions	50
3.6.3. Sample Preparation	52
3.6.4. Optimization of MS/MS Source Settings	54
3.6.5. Precision, Accuracy and Sensitivity	57
3.7. Statistical Analyses	57
<b>4. RESULTS</b>	58
4.1. Calibration Curves	58
4.2. Mass spectra of plasma 7-KC and cholestan-3 $\beta$ ,5 $\alpha$ ,6 $\beta$ -triol	58
4.3. Demographic data including oxysterols of the study groups and controls	60
4.4. Correlations of oxysterol levels with biochemical parameters and coronary multiple risk factors in the study groups	63
4.5. Correlations of oxysterol levels with demographic data, microvascular complications and usage of drugs in the study groups	69
<b>5. DISCUSSION</b>	72
<b>6. REFERENCES</b>	81
<b>7. APPENDIX</b>	
Appendix 1. Ethical Committee	
Appendix 2. Resume	

## ABBREVIATIONS

<b>ACAT</b>	Acyl CoA Cholesterol Acyl Transferase
<b>API</b>	Atmospheric Pressure Ionization
<b>APCI</b>	Atmospheric Pressure Chemical Ionization
<b>APPI</b>	Atmospheric Pressure Photoionization
<b>CNS</b>	Central Nervous System
<b>COX-2</b>	Cyclooxygenase-2
<b>CRM</b>	Charge Residue Model
<b>CYP</b>	Cytochrome P450
<b>DM</b>	Diabetes Mellitus
<b>ER</b>	Endoplasmic Reticulum
<b>ESI</b>	Electrospray Ionization
<b>FAB</b>	Fast Atom Bombardment
<b>FPIR</b>	First-Phase Insulin Release
<b>GC-MS</b>	Gas Chromatography Mass Spectrometry
<b>GDM</b>	Gestational Diabetes Mellitus
<b>HDL</b>	High Density Lipoproteins
<b>HLA</b>	Human Leukocyte Antigen
<b>HMG-CoA</b>	3-hydroxy-3-methyl glutaryl- CoA reductase
<b>HPLC</b>	High Performance Liquid Chromatography
<b>IDF</b>	International Diabetes Federation
<b>IGT</b>	Impaired Glucose Tolerance
<b>IL-6</b>	Interleukin-6
<b>IL-8</b>	Interleukin-8
<b>LCAT</b>	Lecithin Cholesterol Acyl Transferase
<b>LDL</b>	Low Density Lipoproteins
<b>LXRs</b>	Liver X Receptors
<b>LC-MS</b>	Liquid Chromatography Mass Spectrometry
<b>LC-MS/MS</b>	Liquid Chromatography Tandem Mass Spectrometry
<b>MALDI</b>	Matrix-assisted Laser Desorption
<b>MAPKs</b>	Mitogen Activated Protein Kinases
<b>MCP-1</b>	Monocyte chemoattractant protein-1
<b>MMP-9</b>	Matrix Metalloproteinase 9
<b>NCEP</b>	National Cholesterol Education Program
<b>NDDG</b>	National Diabetes Data Group
<b>NF-<math>\kappa</math>B</b>	Nuclear Factor Kappa B
<b>NGT</b>	Normal Glucose Tolerance
<b>OSBPs</b>	Cytoplasmic Oxysterol-Binding Proteins
<b>RNS</b>	Reactive Nitrogen Species
<b>ROS</b>	Reactive Oxygen Species

<b>SCAP</b>	SREBP Cleavage Activating Proteins
<b>SIM</b>	Selected Ion Monitoring
<b>SPE</b>	Solid Phase Extraction
<b>SREBP</b>	Sterol Response Element Binding Protein
<b>TBARS</b>	Thiobarbituric Acid Reacting Substances
<b>TLC</b>	Thin Layer Chromatography
<b>TNF-<math>\alpha</math></b>	Tumor Necrosis Factor-alpha
<b>VLDL</b>	Very Low Density Lipoproteins
<b>WHO</b>	World Health Organization

## FIGURES

<b>Figure</b>	<b>Pages</b>
2.1.	Clinical stages and etiologic types of diabetes <span style="float: right;">7</span>
2.2.	Schematic presentation of the natural history of type 1 diabetes <span style="float: right;">12</span>
2.3.	Global projections for the diabetes epidemic <span style="float: right;">14</span>
2.4.	Proposed sequence of the key pathological features of type 2 diabetes <span style="float: right;">17</span>
2.5.	Oxidative stress pathways in diabetes mellitus <span style="float: right;">20</span>
2.6.	Oxysterols in various age-related diseases. <span style="float: right;">22</span>
2.7.	Structures and CYP enzymes of some enzymatically produced oxysterols <span style="float: right;">25</span>
2.8.	Structures and formation of non enzymatically produced oxysterols <span style="float: right;">26</span>
2.9.	Structure and formation of some important oxysterol <span style="float: right;">27</span>
2.10.	Structure and origin of selected common oxysterols <span style="float: right;">27</span>
2.11.	Non enzymatic and enzymatic cholesterol oxidation products <span style="float: right;">38</span>
2.12.	Modes of metabolism of oxysterols <span style="float: right;">30</span>
2.13.	Physiological and pathological effects of oxysterols <span style="float: right;">34</span>
2.14.	Schematic diagram showing working of MS/MS <span style="float: right;">37</span>
2.15.	The basic components of mass spectrometer <span style="float: right;">38</span>
2.16.	Schematic representation of the electrospray ionization process <span style="float: right;">40</span>
2.17.	The quadrupole mass analyzer <span style="float: right;">41</span>
2.18.	Basic diagram for a mass spectrometer with two analysers <span style="float: right;">42</span>
3.1.	Separation with ACN in contrast with MeOH <span style="float: right;">48</span>
3.2.	Linear gradient representation of mobile phases used during sample Analysis <span style="float: right;">49</span>
3.3.	Separation of in a plasma sample with and without column heater <span style="float: right;">49</span>
3.4.	Product ion spectra and fragmentation pattern of DMG derivative of 7-KC <span style="float: right;">56</span>
3.5.	Product ion spectra and of fragmentation pattern of DMG derivatives of cholestan-3 $\beta$ ,5 $\alpha$ ,6 $\beta$ -triol <span style="float: right;">56</span>
4.1.	The calibration curves for 7-KC and cholestan-3 $\beta$ ,5 $\alpha$ ,6 $\beta$ -triol <span style="float: right;">58</span>
4.2.	Mass spectra/ mass fragmentograms of 7-KC <span style="float: right;">59</span>

<b>4.3.</b>	Mass spectra/mass fragmentograms of cholestan-3 $\beta$ ,5 $\alpha$ ,6 $\beta$ -triol	59
<b>4.4.</b>	Plazma 7-KC levels in type 1, type 2 diabetic patients and controls	62
<b>4.5.</b>	Plazma cholestan-3 $\beta$ ,5 $\alpha$ ,6 $\beta$ -triol levels in type 1, type 2 diabetic patients and controls	62
<b>4.6.</b>	Positive correlation between 7-KC and total cholesterol	66
<b>4.7.</b>	Positive correlation between cholestan-3 $\beta$ ,5 $\alpha$ ,6 $\beta$ -triol and total Total cholesterol	66
<b>4.8.</b>	Positive correlation between 7-KC and HbA1c	67
<b>4.9.</b>	Positive correlation between cholestan-3 $\beta$ ,5 $\alpha$ ,6 $\beta$ -triol and HbA1c	67
<b>4.10.</b>	Positive correlation between 7-KC and number of risk factors	68
<b>4.11.</b>	Positive correlation between cholestan-3 $\beta$ ,5 $\alpha$ ,6 $\beta$ -triol and number of risk factors	68

## TABLES

<b>Table</b>		<b>Pages</b>
<b>2.1.</b>	Nomenclature and origin of oxysterols	23
<b>3.1.</b>	The HPLC parameters	50
<b>3.2.</b>	Preparation of calibration standard working solution	51
<b>3.3.</b>	Mass spectrometric parameters	54
<b>3.4.</b>	Mass transitions of 7-KC and cholestan-3 $\beta$ ,5 $\alpha$ ,6 $\beta$ -triol	55
<b>4.1</b>	Clinical and biochemical profiles of the studied groups	60
<b>4.2.</b>	Coronary disease risk factors based on the criteria of national cholesterol education program	63
<b>4.3.</b>	Correlations between oxysterols and biochemical parameters as well as BMI, waist circumference and number of risk factors in type 2 diabetic patients	64
<b>4.4.</b>	Correlations between oxysterols and biochemical parameters as well as BMI, waist circumference and number of risk factors in type 1 diabetic patients	65
<b>4.5.</b>	Evaluation of the correlation between 7-KC, and demographic data, microvascular complications and usage of drugs of type 1 diabetic patients	69
<b>4.6.</b>	Evaluation of the correlation between 7-KC, and demographic data microvascular complications and usage of drugs of type 2 diabetic patients	70
<b>4.7.</b>	Factors affecting 7-KC and cholestan-3 $\beta$ ,5 $\alpha$ ,6 $\beta$ -triol in type 2 DM group	71

## 1. INTRODUCTION

Diabetes Mellitus (DM) is a chronic metabolic disorder that affects around 150,000,000 people in the world. Its prevalence is rising quickly and fast-progressing global problem with social, health, and economic consequences. It was initially illustrated in the Egyptian papyrus Ebers in 1500 BC. DM has distinctive complications that is characterized by chronic hyperglycemia with disturbances of carbohydrate, fat and protein metabolism resulting from defects in insulin secretion, insulin action, or both (1).

The chronic hyperglycemia of DM is associated with continuing damage, dysfunction, and failure of different organs, mainly the eyes, kidneys, nerves, heart, and blood vessels. The difference in the mechanisms for developing the different types of diabetes forms the basis of its classification. Previously, the categorization of diabetes mellitus was based on clinical findings such as age of onset, so-called juvenile- or adult-onset diabetes, or treatment procedures, such as insulin-dependent versus non-insulin-dependent diabetes. In 1999 the National Diabetes Data Group (NDDG) in conjunction with World Health Organization (WHO) changed and published new and unified criteria for the classification and diagnosis of DM (2). Intensive scientific research worldwide has brought new insight into this disease with modern management methods. Oxidative stress plays an important role in the pathophysiology of DM and oxysterols which result from spontaneous or enzymatic oxidation of cholesterol, are potentially non-invasive biomarkers of oxidative stress in vivo. In this study, we aimed to evaluate oxysterol species (7-ketocholesterol and cholestan-3 $\beta$ ,5 $\alpha$ ,6 $\beta$ -triol) as sensitive oxidative stress biomarkers in type 1 and type 2 DM by LC/MS-MS method and foresee/monitor the potential complications of DM.



## **2. GENERAL INFORMATION**

### **2.1. Diabetes Mellitus**

#### **2.1.1. History of Diabetes Mellitus**

The story of the earliest recognition of diabetes and the path to the discovery of insulin is filled with marvelous insights. DM is one of the first metabolic diseases documented by Egyptian manuscript, the Ebers papyrus, from 1500 BC. Medical features with distinctive complications producing excessive thirst, polyuria, and severe weight loss that ancient Egyptians described almost 3000 years ago exclusively cases of what is today known as a DM. The name "Diabetes" was the first description that is given by the ancient Greek physician Aretaeus of Cappadocia in the second century (81-133AD). He was the first to distinguish between what we now call DM and diabetes insipidus and conditions causing increased urine output. Later, the term "Mellitus" (honey sweet) was added by Thomas Willis an English doctor and a professor of anatomy, neurology at Oxford, in 1675 (17th century) after rediscovering the sweetness of urine and blood of patients. He revealed (by testing) that the urine of persons with diabetes was sweet (3-5).

In 1776, another British doctor named Matthew Dobson demonstrated in his experiments that serum of individuals with DM actually contains a sweet tasting substance that excrete sugar in the urine and thus discovered hyperglycemia (6). He noted that the residue of boiling urine to dryness, a crystalline material, had the appearance and taste of brown sugar. Dobson puts forward the theory that the diabetes was a systemic disease, rather than one of the kidneys (6,7). Between 1840 and 1860, physiologic studies in metabolism began their advance, especially in France under the management of Claude Bernard, professor of physiology at Sorbonne University. Bernard made numerous discoveries, including the observation that the sugar, which appears in diabetic urine was stored in the liver in the form of glycogen.

The two strongest forces arguing for a “pancreatic “factor in the etiology of diabetes were Apollinaire Bouchardat and E.Lancereaux. Bouchardat, was an early pioneer in the study of human diabetes (8). Claude Bernard’s clinical experience taught him to distinguish at least two diverse types of diabetes: the severe type, in younger persons who responded weakly to his regimen and the type in older, obese persons. Lancereaux and his colleagues came to the same conclusions about etiology and introduced the terms diabete maigre (diabetes of the thin) and diabete gras (diabetes of the fat) for the two usual clinical forms of disease (9). Discovery of insulin by Frederick Banting and Charles Best was the last step in identifying the substance whose absence had been postulated to be responsible for development of diabetes. This milestone, however, was preceded by a number of earlier significant advances. In the fifth century AD, Sushruta and Charaka, two Indian physicians, were the first to differentiate between the two types of DM (3).

### **2.1.2. Diabetes Mellitus Definition**

DM is a group of metabolic disorders characterized by hyperglycemia resulting from defects in insulin action, insulin secretion, or both. The chronic hyperglycemia of DM is associated with dysfunction, long-term damage, and failure of different organs, especially the kidneys, eyes, nerves, heart, and blood vessels that called as mikrovascular and makrovascular complications of diabetes (10). A number of pathogenic processes are associated with the development of diabetes. These range from autoimmune damage of the  $\beta$ -cells of the pancreas with consequent insulin deficiency to abnormalities that result in resistance to insulin action (10).

### **2.1.3. Clinical Signs and Symptoms**

Symptoms of marked hyperglycemia include polyphagia, polyuria, polydipsia, weight loss, urinary tract infections, fatigue and blurred vision. Impairment of growth and susceptibility to certain infections may also accompany chronic hyperglycemia (11, 12). One of the most important complications that associated with diabetes mellitus is an increasing risk of developing microvascular and macrovascular (coronary and cardiovascular disease) problems that contribute to greater morbidity and mortality of patients (13). Long-standing microvascular complications of diabetes include nephropathy leading to renal failure, retinopathy with potential loss of vision, peripheral neuropathy with risk of foot ulcers, amputations and Charcot joints. Autonomic neuropathy causes gastrointestinal, genitourinary, and cardiovascular symptoms and sexual dysfunction (11). Diabetic retinopathy may be the most common microvascular complication of diabetes (14). Development of diabetic retinopathy or other microvascular complications of diabetes depends on both the duration and the severity of hyperglycemia (14). The same as other microvascular complications, development of diabetic neuropathy is proportional to both the magnitude and duration of hyperglycemia, and some patients may possess genetic attributes that affect their predisposition to developing such complications (14). Patients with DM have an increased incidence of macrovascular complications such as peripheral arterial, cerebrovascular and atherosclerotic cardiovascular disease. Abnormalities of lipoprotein metabolism and hypertension are often found in people with DM (11). In its most severe forms, ketoacidosis or a non-ketotic hyperosmolar state may develop and lead to stupor, coma and, in the absence of effective treatment, death (15-17).

#### **2.1.4. Diabetes Mellitus Diagnostic Criteria**

The diagnostic criteria were initially established by the NDDG and WHO in 1979-80. According to the report in 2010, any one of the following is considered diagnostic of diabetes (18). Besides the symptoms of DM (polydipsia, polyuria) the plasma glucose measured at any time is  $\geq 200$  mg / dL or fasting plasma glucose is  $\geq 126$ mg / dL or oral glucose tolerance test (OGTT) in 2nd hour is  $\geq 200$  mg / dL. In each case, measurement of glucose concentration should be repeated on a second occasion to confirm the diagnosis. Individuals with IFG (impaired fasting glucose) and/or IGT(impaired glucose tolerance) have been referred to as having prediabetes, indicating the relatively high risk for the future development of diabetes. IFG and IGT should not be viewed as clinical entities in their own right but rather risk factors for diabetes as well as cardiovascular disease. These people were defined as having IFG, fasting plasma glucose (FPG) levels 110 mg/dL to 126 mg/dL, or IGT [2-h values in the oral glucose tolerance test (OGTT) of 200 mg/dL (19).

IFG and IGT are associated with obesity (especially abdominal or visceral obesity), dyslipidemia with high triglycerides and/or low HDL cholesterol, and hypertension. Structured lifestyle intervention, aimed at increasing physical activity and producing 5–10% loss of body weight, and certain pharmacological agents have been demonstrated to prevent or delay the development of diabetes in people with IGT; the potential impact of such interventions to reduce mortality or the incidence of cardiovascular disease has not been demonstrated to date.

### **2.1.5. Diabetes Mellitus Clinical Stages**

Diabetic patients pass through several clinical stages during development of disease. At the beginning, glucose regulation is normal and no abnormality of glycemia can be identified even if these individuals undergo an oral glucose tolerance test (OGTT). This stage is followed by a period of variable duration in which glucose regulation is impaired. Diabetes itself is characterized by either fasting glycemia or marked abnormalities of glucose tolerance, or both (20). All patients with diabetes can be classified according to clinical stage regardless of the underlying etiology of the diabetes. Impaired glucose regulation refers to the metabolic stage intermediate between normal glucose homeostasis and diabetes that can be identified by impaired glucose tolerance (IGT) or impaired fasting glucose (IFG) (21).

IFG and IGT are not synonymous and may represent different abnormalities of glucose regulation. Patients with either of these states of impaired glucose regulation have a high risk of progressing to diabetes (22, 23). IGT can be assessed only if OGTTs are carried out, whereas IFG involve fasting glucose concentrations that are lower than those required for the diagnosis of diabetes, but higher than those usually found in subjects with normal glucose tolerance. Individuals with IGT or IFG generally have normal or lightly high levels of glycosylated hemoglobin (24). IGT is usually associated with the existence of other indicators of the metabolic or insulin resistance syndrome (25).

Stage Type	Normo-glycemia	Hyperglycemia		
	Normal glucose relation	Impaired regulation glucose FG* IGT*	Diabetes mellitus insulin unnecessary necessary necessary	
Type 1	██████████	██████████	██████████	██████████
Type 2	██████████	██████████	██████████	██████████
Other	██████████	██████████	██████████	██████████
Gestational DM	██████████	██████████	██████████	██████████

\*IFG = impaired fasting glycemia  
\*IGT = impaired glucose tolerance

**Figure 2.1.** Clinical stages and etiologic types of diabetes (26)

### 2.1.6. Classification of Diabetes Mellitus

The difference in the mechanisms for developing the diverse types of diabetes forms the basis of their categorization. The current classification includes four main categories (16). Previously, the classification of diabetes mellitus was depended on clinical findings such as age of onset, so-called juvenile or adult- diabetes, or treatment procedure, such as insulin-dependent or non-insulin-dependent diabetes. In 1979 the National Diabetes Data Group (NDDG) together with World Health Organization (WHO) revised and published new and unified principle for the classification and diagnosis of this disease (27). The terms type 1 and type 2 diabetes mellitus replaced the previous treatment based terminology, IDDM and NIDDM. The third group includes other less frequent types of diabetes that are caused certain specific circumstances and/or syndromes. The last group includes diabetes diagnosed throughout pregnancy, called gestational diabetes (GD).

### **I. Diabetes mellitus type 1**

- A. Autoimmune
- B. Idiopathic

### **II. Diabetes mellitus type 2**

- A. Insulin resistance predominates over the relative defects in hormone secretion
- B. Defects in insulin secretion predominate over the presence of insulin resistance

### **III. Gestational Diabetes Mellitus**

### **IV. Other specific types of diabetes mellitus**

#### **A. Genetic defects of $\beta$ -cell function**

1. Chromosome 12, HNF-1 $\alpha$  (MODY 3)
2. Chromosome 7, glycosidase (MODY 2)
3. Chromosome 20, HNF-4 $\alpha$  (MODY1)
4. Mitochondrial DNA
5. Others

#### **B. Genetic defects in insulin action**

1. Type A insulin resistance
2. Leprechaunism
3. Rabson-Mendenhall syndrome
4. Lipotrophic syndrome
5. Others

#### **C. Endocrinopathies**

1. Acromegaly
2. Cushing syndrome
3. Pheochromocytoma
4. Hyperthyroidism
5. Somatostatinoma
6. Glucagonoma
7. Aldosteronoma

**D. Drug or chemical induced**

1. Vactor

2. Pentamidine

3. Dilantin

4. Thyroid hormones

5. Nicotinic acid

6. Others

**E. Infections****F. Other immune-mediated (uncommon)****G. Other specific genetic syndromes associated with diabetes**



## Diabetes Mellitus Type 1

Type 1 Diabetes Mellitus (T1DM), well-known as insulin dependent diabetes or juvenile onset diabetes is the classical life threatening form of diabetes. This form of immune-mediated diabetes usually occurs in infancy and adolescence (<35 years) but can happen at any age, with about half the cases being diagnosed in childhood (13). Diabetes occurring earlier than the age of 6 months is more likely to be monogenic neonatal diabetes rather than autoimmune T1DM (28, 29). It usually counts for 5-10% of all cases of diabetes. T1DM is a progressive form of the disease with multifactorial etiology that principally associated with cellular mediated autoimmune damage of the pancreas  $\beta$ -cells by activating  $CD4^+$  and  $CD8^+$  T cells and macrophages infiltrating the pancreatic islets that usually lead to severe insulin deficiency (30-32). The amount of  $\beta$ -cell destruction is quite variable, particularly in infants and kids, and slower in adults. The subsequent lack of insulin leads to increased blood and urine glucose. There are some evidences proposing that type 1 diabetes is a virus-triggered (Coxsackie virus family or rubella) autoimmune response in which the immune system attacks, virus-infected cells in conjunction with the beta cells in the pancreas (33, 34).

The term insulin-dependent is vitally important, because it indicates the fact that these individuals depend on insulin treatment for their survival, and will die unless it's given. In patients with T1DM the process of  $\beta$ -cell destruction can be recognized earlier by the existence of certain auto antibodies (15). These individuals are metabolically normal before the disease is clinically revealed. T1DM is usually characterized by the presence of anti-GAD, islet cell autoantibodies (ICAs) or insulin autoantibodies (IAAs), glutamic acid decarboxylase and autoantibodies to the tyrosine phosphatases IA-2 and IA-2 $\alpha$  auto antibodies (GAD65), which reflects the autoimmune mechanisms that have contributed to  $\beta$ -cell destruction (35, 36) At least one or more of these autoantibodies are present in almost 90% of the new-onset cases, and thus can be used clinically for diagnosing the disease. Patients who have one of more of these antibodies can be sub classified as having type 1 immune mediated type 1 diabetes (37).

T1DM has further been classified into type 1A (immune mediated) and type 1B diabetes is the form of disease with severe insulin deficiency without evidence of  $\beta$ -cell autoimmunity and relatively more common in African and Asian populations (38). Type 1A diabetes is greatly associated with specific human leukocyte antigen (HLA) and its characterized with insulinitis (39). There is a novel subtype of Type 1B diabetes called “fulminant” type 1 diabetes (40). Patients with type 1A diabetes are more prone to have other related autoimmune disorders such as Graves’s disease or pernicious anemia (15). According to genetic studies there is a strong relation between type 1A diabetes and specific haplotypes or alleles at the DQ-A and DQ-B loci in the HLA complex (41).

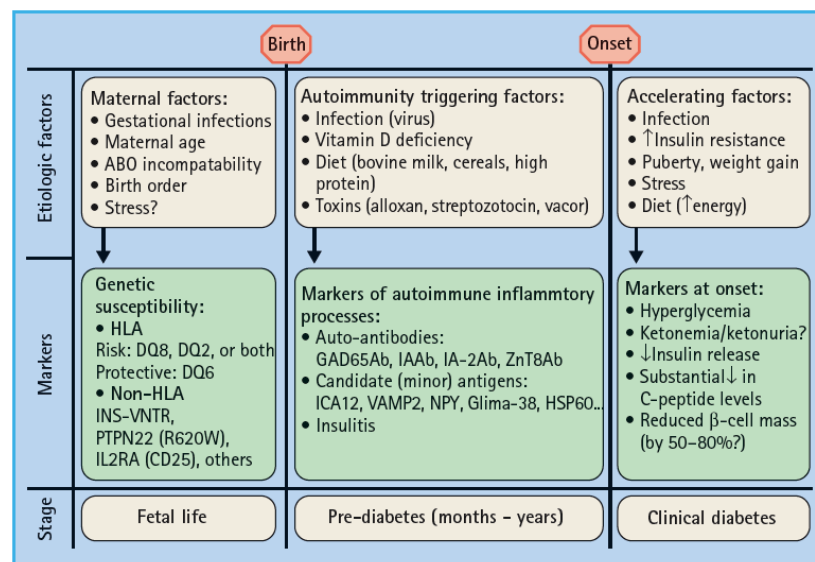
The HLA proteins are situated on the cell surfaces that assist the immune system to differentiate body's normal cells from alien infectious and non-infectious agents (28). A few individuals carry on a different form of T1DM, called idiopathic diabetes that does not associate with autoimmunity. It is less prevalent than the autoimmune T1DM, and is found in African and Asian populations. The etiology and pathogenesis of this form not well understood, but the patients are face with severe insulin deficiency and are prone to ketoacidosis in the lack of antibodies to  $\beta$  cells (16, 24). Some interpretive studies have been indicated, for the cause of this disease such as genetic susceptibility, a diabetogenic trigger, and exposure to an antigen (29).

### **Pathophysiology and Clinical Features of Diabetes Mellitus Type 1**

Diabetes mellitus type 1 main clinical features reflect significant insulin deficiency. Generally, the  $\beta$  cell damage is immune mediated and other clinical features arise related to other autoimmune processes. The classical clinical picture of type 1 diabetes mellitus represented by high levels of urination (polyuria), sometimes noticeable at night (nocturia), polydipsia, polyphagia excessive thirst, feeling tired all the time, unexplained weight loss, loss of muscular bulk, muscle weakness, impairment of the visual function, abdominal pain, bowel movement disorders, impairment of the

peripheral nerves, with numbness in the extremities. These symptoms result from the underlying hyperglycemia that is in turn caused by insufficient insulin functionality (42). These pathology features may occur suddenly, even associated with diabetic ketoacidosis. The complications of the disease are multiple and various, such as infections in different parts of the body, neuropathy nephropathy, ophthalmologic, cardiac complications, atherosclerosis (42).

Before the clinical symptoms of type 1 diabetes become apparent Some silent immune procedures happen. Particularly, autoantibodies are produced and self-reactive lymphocytes become activated and infiltrate the pancreas to destroy the insulin-producing beta-cells in the islets of Langerhans (43, 44). There is two different pathophysiologic mechanisms stages in genetically susceptible T1DM patients; first, Triggering of autoimmunity resulting in one or multiple islet cell autoantibodies associated with gradual  $\beta$ -cell killing; and the other stage is, Loss of  $\beta$ -cell secretory function manifested by the loss of first-phase insulin release (FPIR), reduced C peptide levels, then glucose intolerance and finally hyperglycemia (45) (Figure 2-3).

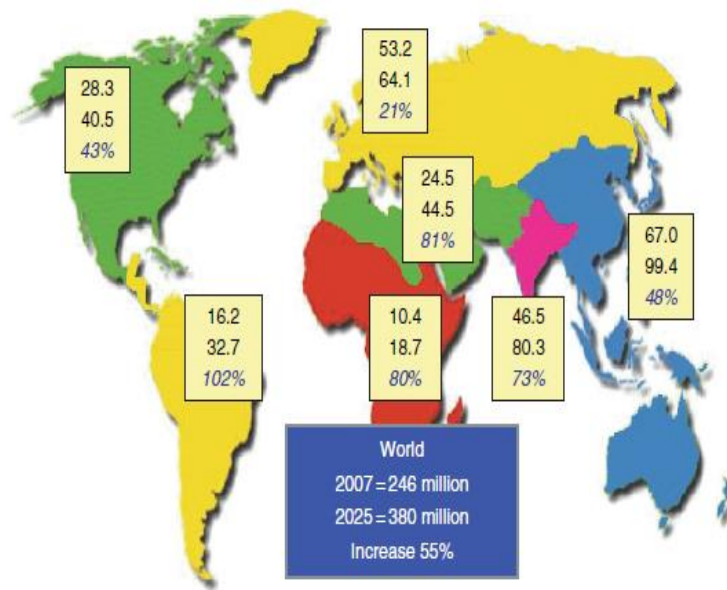


**Figure 2.2.** Schematic presentation of the natural history of T1DM, showing possible etiopathologic factors and disease markers (16)

## **Epidemiology of Diabetes Mellitus Type 1**

Diabetes mellitus is a vast and spreading problem, and the costs to society are high. The incidence of T1D alters in different countries and populations (46, 47). Type 1 diabetes rarely happens during the first year of life. The age specific prevalence rate of diabetes mellitus differs extremely across the normal life span and populations typically have different age distributions (15). Relevant comparisons among populations must be based on a special age specific rate (48). T1DM is the most frequently faced chronic disease of childhood. It is accepted that T1DM prevalence is increasing among children all around the world. Reported figures for T1DM incidence in childhood point out a large variety among different populations (49, 50). This variability is explained by differences in ethnic background, geographical district and region, and level of industrial development (51, 52).

Turkey contains a variety of communities and located between Europe and Asia. In this country data on incidence of T1DM are very limited. The 5th edition of the world diabetes atlas, published in 2011 by the International Diabetes Federation (IDF), contains no data on the incidence of pediatric diabetes in Turkey (53). The plan of occurrence of type 1 diabetes over time can be important evidence in discriminating between alternative etiologic hypothesis pattern (15). Solutions and guidelines for this disease must be forthcoming because treatment for individuals with T1DM exists and should be universally distributed (54).



**Figure 2.3.** Global projections for the diabetes epidemic (55)

### 2.1.7. Diabetes Mellitus Type 2

Diabetes mellitus type 2, formerly known as non-insulin-dependent diabetes mellitus or adult-onset diabetes is a complex metabolic disorder of heterogeneous etiology is the most frequent type of diabetes, associated with excess morbidity and mortality and it's a worldwide health crisis (56). This diabetes is often characterized by central or visceral obesity. Most of T2DM patients are obese when they develop diabetes, and obesity aggravates the insulin resistance (15). In this disorder, hyperglycemia is caused by deficiency in insulin secretion and action.

Type 2 diabetes is associated with complex metabolic disorders such as progressive  $\beta$ -cell dysfunction and insulin resistance that are significant features of the disease (57, 58). Diversity of adipose tissue-derived cytokines, such as leptin, adiponectin, retinol-binding protein 4, IL-6, TNF- $\alpha$ , and other inflammatory proteins affect insulin sensitivity and low levels of physical activity and aging also contribute to insulin resistance.

This illness is more frequent after 40 years of age, but now it's shown to be growing in young adults and adolescents due to the increase in obesity (59). There are some metabolic alterations associated with T2DM such as hypertension, obesity and dyslipidemia (13). Ketoacidosis occurs rarely, but can arise with stress associated with another illness such as infection (15). The exact cause of T2DM is not recognized, but lifestyle and genetic factors rendering the disease with a very heterogeneous phenotype (60). Environmental factors such as toxins, diet and obesity play an important role in the development of increases in the rate of T2DM in addition to any genetic component and it is becoming more common in developing countries, afflicting younger individuals particularly ethnic minorities (3, 13).

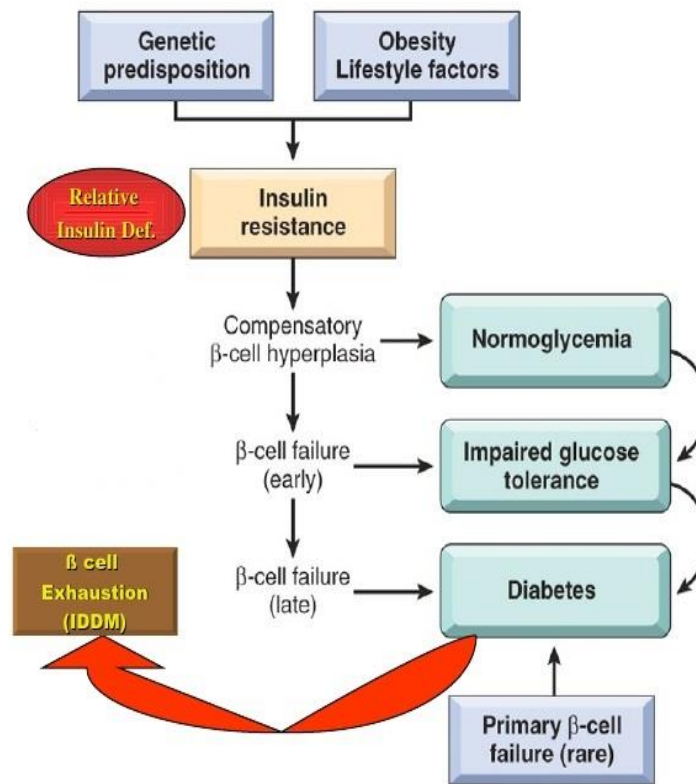
In type 2 diabetes mellitus, unlike type 1, insulin resistance is typically a problem of insulin receptors of the cells, which do not respond properly to insulin rather than a problem with the production of insulin (13). Elevated fasting glucose, abnormal glucose tolerance test, obesity and impaired insulin action are the best predictors of increased diabetes risk and progression to diabetes (61, 62). T2DM is occur commonly in women who have a previous history of gestational diabetes and in individuals with other characteristics of the insulin resistance syndrome, such as hypertension or dislipidemia (15).

### **Pathophysiology and Clinical Features of Diabetes Mellitus Type 2**

The typical type 2 diabetic patients are an obese individuals frequently without any symptoms (3). The classical clinical picture of type 1 diabetes mellitus represented by some hyperglycemic symptoms such as polydipsia, polyuria and fatigue but most of patients diagnosed incidentally by screening or during medical examinations conducted for unrelated reasons. In T2DM hyperglycemia usually associated with increased levels of the gluconeogenic precursors such as lactate, alanine, pyruvate, and glycerol (3). Some patients with T2DM diagnosed when they present with infections principally urinary tract, and skin infections and genital candidiasis. In some other patients clinical

features present with complications of the diabetic condition itself, most commonly complications are macrovascular disease manifesting as angina, myocardial infarction, stroke, or peripheral vascular disease (63). Obesity is the hallmark of T2DM. Adipose tissue expanding in the obese state, thus synthesizes and secretes metabolites and signaling proteins such as adiponectin, TNF- $\alpha$ , leptin, and visfatin. These factors are known to alter insulin secretion and sensitivity and even cause insulin resistance under experimental and clinical conditions (64, 65).

A small fraction of type 2 diabetic patients present microvascular complications like retinopathy, maculopathy, neuropathy and nephropathy (16). Therefore, tissue damage can be detected clinically at the time of diagnosis in a large percentage of patients (66). In type 2 DM retinopathy particularly maculopathy, cataracts, and neuropathy are also common conditions that contribute to morbidity (3). The progression from normal glucose tolerance (NGT) to type 2 DM involves intermediate stages of IFG and IGT, also known as prediabetes. The pathophysiology mechanism underlying the progression of these glucose metabolic variations is multifactorial (67). Clinical features in obese children and adolescents affected by IGT and type 2 diabetes are characterized by severe insulin resistance, which is associated with an increased lipid aggregation in visceral compartments, liver and muscle tissues and by reduced sensitivity of  $\beta$ -cell of first and second-phase insulin secretion (67, 68). Adolescents with type 2 DM are also prone to secondary obesity-related complications, such as hypertension, liver disease and metabolic syndrome (69).



**Figure 2.4.** Proposed sequence of the key pathological features of type 2 diabetes (70)

### Epidemiology of Diabetes Mellitus Type 2

During the last years, changes in daily lifestyles have led to an impressive raise in the prevalence of type 2 DM in virtually every society around the world and it becomes a worldwide and international health issue (71, 72). Surprisingly the grow in prevalence of type 2 DM is seen in all six inhabited continents of the world (73). Increases in urbanization and dietary intake, reduction in physical activity, the rise in obesity and the aging of the population are main factors in bringing about this rapid change and contributed to a dramatic increase of type 2 DM in many parts of the world (74). Type 2 diabetes mellitus affects around 3% of the population or 100 million people worldwide (3).



There are nearly 150 million people throughout the world suffer from type 2 DM and its going to increase and that this number will rise to 300 million by 2025 and costs many nations millions of dollars for healthcare (15, 71). The incidence of type 2 DM has now been illustrated in different countries, enabling a good understanding of global disease patterns. One of the most important, distressing consequences of the diabetes epidemic is the emergence of type 2 diabetes in children and adolescents and it brings a serious new aspect type 2 DM occurs in all races (75, 76).

The incidence rate of type 2 DM among children and adolescents varies extremely by nationality with the highest rates recognized among youths aged 15–19 years in minority populations (67, 77). The elevated incidence of type 2 DM in the obese pediatric population is paralleled by an increased prevalence of the prediabetes conditions. Specially, 25% of children and 21% adolescents with severe intensity of obesity, irrespective of ethnicity, were found to have IGT (78). Increasing number of obese children and adolescents affected by type 2 DM and the fast development of glucose homeostasis dysregulation in this age group explain why type 2 DM is becoming one of the most important public health crisis.

#### **2.1.8. Gestational Diabetes Mellitus (GDM)**

Gestational diabetes mellitus (GDM) is a common metabolic disorder that has been defined as any degree of glucose intolerance associated with hyperglycemia of variable severity with the onset or first recognition (79). This type of diabetes occurs especially during the third trimester of pregnancy. This period of pregnancy is accompanied with increased insulin sensitivity and its associated with most common maternal and fetal complications of pregnancy, most notably macrosomia (27, 80, 81). This clarification does not exclude the possibility that unrecognized glucose intolerance may have antedated the pregnancy thus the term hyperglycemia in pregnancy emerges to be more appropriate as suggested lately by the endocrine society (82).

Patients with GDM have an impaired ability to secrete insulin in contrast to normal pregnant women (83). The prevalence of GDM is increasing in many populations worldwide as obesity becomes more prevalent (84). Patients with GDM are more likely to suffer complications such as preeclampsia, operative delivery and stillbirth (85). Postpartum management of women with gestational diabetes is critical because in long term period kids born to mothers with this type of diabetes are at greater risk of obesity and type 2 DM in future life (86, 87). Most of these risks can be reduced by identification of GDM pregnancies therefore reducing the maternal antenatal hyperglycaemia (88). Diagnosis of this kind of diabetes is determined by the results of an OGTT (3).

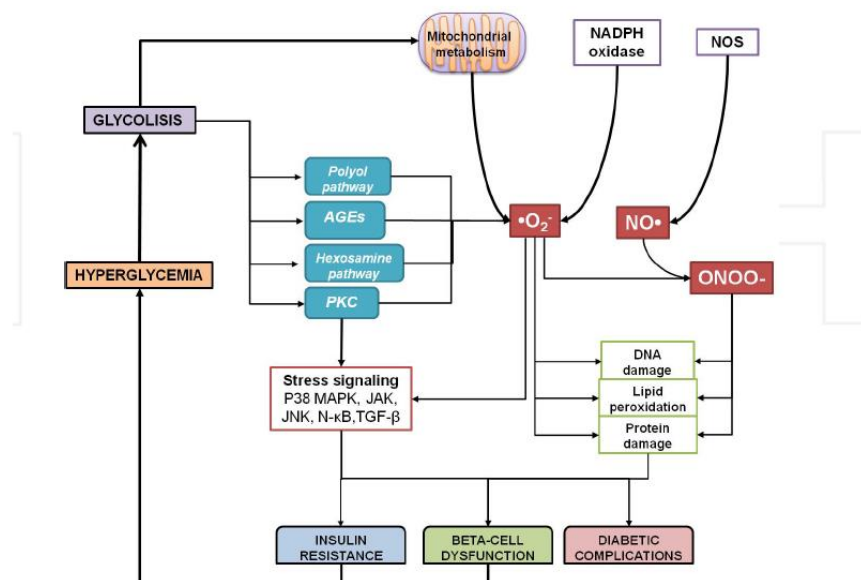
## **2.2. Diabetes Mellitus and Oxidative Stress**

Oxidative stress has been used to describe a condition in which reactive oxygen species (ROS) and reactive nitrogen species (RNS) reach extreme levels, either by excess production or inadequate removal (89). Excess production of these molecules lead to physiological dysfunction, cell death and pathologies such as diabetes, cancer and aging of the organism (90). These molecules also affect the insulin signaling cascade (91). Researches on DM and oxidative stress suggests that oxidative stress plays an important role in the pathogenesis of DM, its complications and progress (89, 92). There are two main factors including, hyperglycemia and glucotoxicity that are usually considered as principal driving sources in diabetes related oxidative stress (93). Oxidative stress is increases due to hyperglycemia, which contributes to the impairment of the insulin action and insulin secretion (89).

Additionally antioxidant mechanisms are decreased in diabetic patients which may further enhance oxidative stress (91, 94). Reactive oxygen species are formed through glucose auto-oxidation, nonenzymatic glycation of proteins, activation of NADPH oxidase and protein kinase C, strengthen of the polyol pathway and enhancement of the mitochondrial electron transport chain during hyperglycemia in

diabetic patients (89) (Figure 2.5). Furthermore, alteration in antioxidant enzymatic systems as superoxide dismutase, catalase and glutathione reductase, impaired glutathione metabolism, decreased vitamin c levels decline antioxidant defense mechanisms in DM (95). High levels of free radicals and simultaneous decline in antioxidant mechanisms lead to damage of cellular organelles and enzymes, increased lipid peroxidation, and development of insulin resistance. Therefore, diabetic patients have more oxidative cell and organism environments than healthy individuals (91, 96).

Any disturbance in cellular redistribution of insulin signaling components may alter the insulin cascade, a process which is also mediated by NF- $\kappa$ B (97). Stress signaling pathways, such as NF- $\kappa$ B activity, are increased by ROS in the  $\beta$ -cells of the pancreas, which potentially leading to  $\beta$ -cell apoptosis (98). Therefore, oxidative stress is presently accepted as a likely causative factor in the development of insulin resistance. Insulin resistance and hyperglycemia may also lead to altered mitochondrial function and insulin action impairment by cytokines in response to metabolic stress (99, 100).

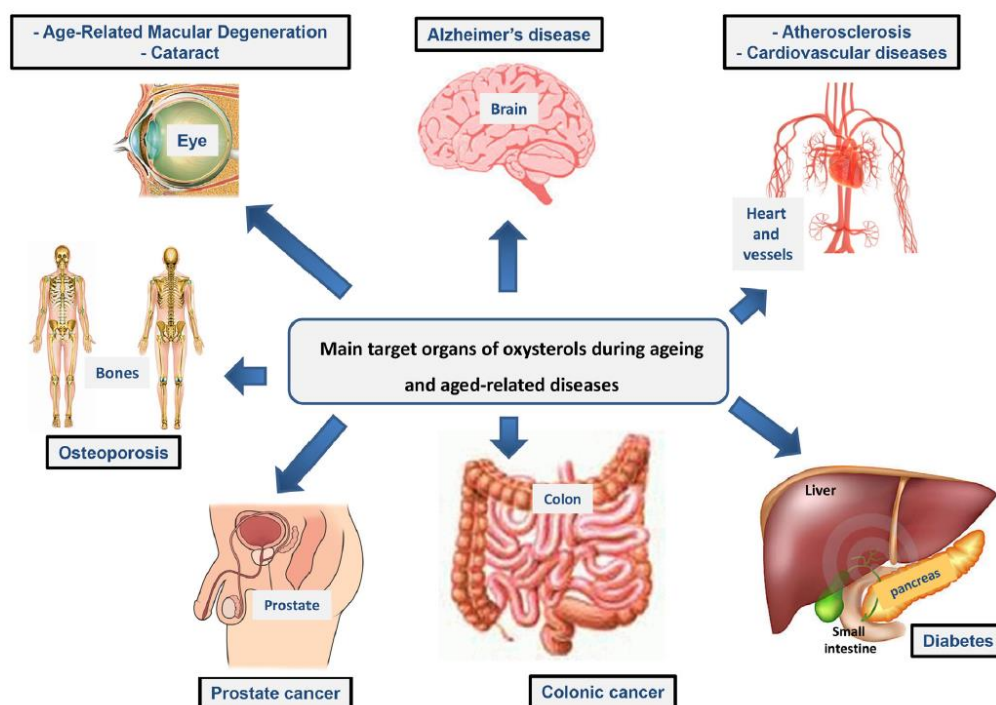


**Figure 2.5.** Oxidative stress pathways in diabetes mellitus (89)

### 2.3. Oxysterols

Cholesterol is present in all over the mammalian tissues. Its also an essential structural component of cell membranes. Oxidation of cholesterol leads to the formation of a large number of oxidation products known as oxysterols. Oxysterols are structurally identical to cholesterol, but with one or more extra oxygen containing functional groups on the cholesterol A or B rings or side chain (101). Therefore, oxysterols are -hydroxy, -keto or -epoxy oxidation products of cholesterol/phytosterols or end products of the cholesterol biosynthetic process. They are formed by enzymatic action or auto-oxidation and have numerous biological activities (102).

Some oxysterols thought to be damaging, whereas some others may play important physiological roles. Some specific oxysterols have the potential to either control cholesterol biosynthesis or directly interfere with normal cellular functions of cholesterol (101). Some major oxysterols formed as intermediates in the pathways converting cholesterol to bile acids and steroid hormones (103). They are intermediates in sterol biosynthesis and they act as signalling elements (104, 105). Oxysterols are also bioactive molecules in their own right, being ligands to nuclear receptors and also regulators of the processing of steroid regulatory element-binding proteins (SREBPs) to their active forms as transcription factors regulating cholesterol and fatty acid biosynthesis (106). Oxysterols are also transportable forms of sterol (107). These compounds are implicated in the pathogenesis of multiple disease states (106) (Figure 2-6).



**Figure 2.6.** Oxysterols in various age-related diseases. Based on in vitro studies, animal studies and clinical investigations (103)

Oxysterols can be produced from either the spontaneous or enzymatic oxidation of cholesterol (108). Oxysterols can be formed endogenously by (ROS) (109, 110). Most of the physiologically important oxysterol species are generated by enzymes in cells by mitochondrial or endoplasmic reticulum cholesterol hydroxylases belonging to the cytochrome P450 (CYP) family (111, 112). Table 2.1 shows some major oxysterols.

**Table 2.1.** Nomenclature and origin of oxysterols

Abbreviation Principle source	Common name	IUPAC name
22(R) OHC	22(R)- hydroxycholesterol	Cholest-5-en-3 $\beta$ ,22(R)-diol
24(S) OHC	24(S)- hydroxycholesterol	Cholest-5-en-3 $\beta$ ,24(S)-diol
25 OHC	25- hydroxycholesterol	Cholest-5-en-3 $\beta$ ,25-diol
27 OHC	27- hydroxycholesterol	Cholest-(25R)-5-ene-3 $\beta$ ,27-diol
4 $\beta$ OHC	4 $\beta$ - hydroxycholesterol	Cholest-5-ene-3 $\beta$ ,4 $\beta$ -diol
7 $\alpha$ OHC	7 $\alpha$ - hydroxycholesterol	Cholest-5-en-3 $\beta$ ,7 $\alpha$ -diol
7 $\beta$ OHC	7 $\beta$ - hydroxycholesterol	Cholest-5-en-3 $\beta$ ,7 $\beta$ -diol
7 KC	7- ketocholesterol	Cholest-5-en-3 $\beta$ -ol-7-one
5 $\alpha$ 6 $\alpha$	5 $\alpha$ ,6 $\alpha$ - Epoxy cholesterol	Cholestan-5 $\alpha$ ,6 $\alpha$ -epoxy-3 $\beta$ -ol
5 $\beta$ 6 $\beta$ EC	5 $\beta$ ,6 $\beta$ - Epoxycholesterol	Cholestan-5 $\beta$ ,6 $\beta$ -epoxy-3 $\beta$ -ol
Zymo*	Zymosterol	5 $\alpha$ -cholesta-8,24-dien-3 $\beta$ -ol
Desmo*	Desmosterol	3 $\beta$ -hydroxy-5,24-cholestadiene
7DHC*	7- dehydrocholsterol	Cholesta-5,7-dien-3 $\beta$ -ol

\*Other sterols which are regulators of cholesterol homeostasis

Knowledge of the mechanisms for oxysterols specially 7-ketocholesterol (7-KC) generation and metabolism may provide therapeutic drug targets (108). 7-KC is a good marker of autoxidation (113, 114). Inquiry and analysis of oxysterols are challenging on account of their low abundance in biological systems in comparison to cholesterol, and due to the propensity of cholesterol to undergo oxidation in air to generate oxysterols with the same structures as those present endogenously (106).

### 2.3.1. Formation of oxysterols

There are some routes by which oxysterols are derived from cholesterol. Biological oxysterols can be divided, in general, into two main categories; those oxygenated on the side chain and those oxygenated on the sterol ring structure. The side chain oxygenated oxysterols are mostly formed enzymatically while the ring oxygenated oxysterols usually have a non-enzymatic origin (115).

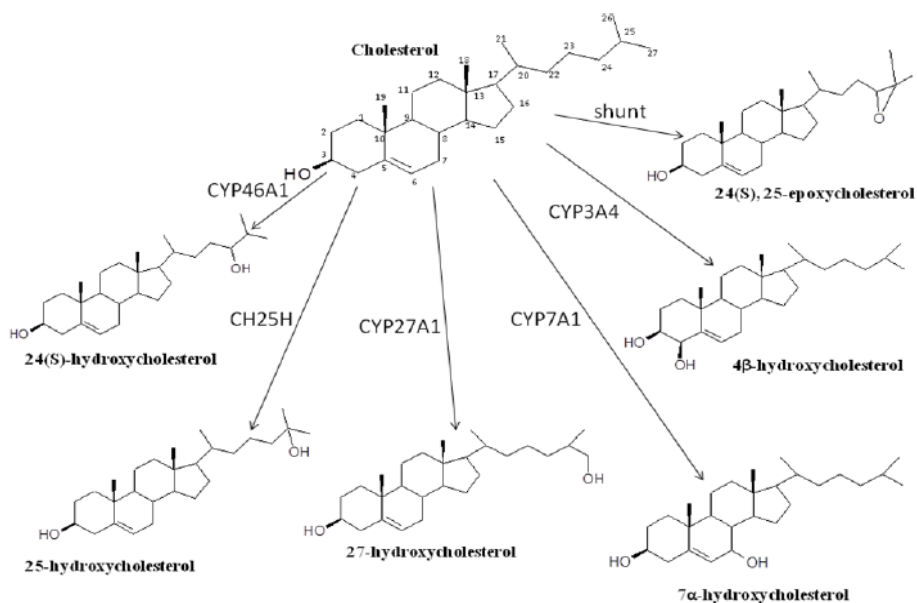
A few exceptions to this rule are 25-hydroxycholesterol and 7 $\alpha$ -hydroxycholesterol which can be produced by both enzymatic and non- enzymatic routes (101).

### **Enzymatic Oxidation**

The side chain oxygenated oxysterols are mostly formed enzymatically. The hydroxylation of cholesterol side chain take place with the activity of mitochondrial or endoplasmic reticulum cholesterol hydroxylases belonging to the cyp family (Figure 2.7) (104, 107).

The major oxysterols that arise enzymatically are:

- 24(S)-hydroxycholesterol (24(S) OHC). It is synthesized in the central nervous system (CNS) by the action of cholesterol 24-hydroxylase enzyme (CYP46A1). It is the key route for cholesterol excretion from neuronal tissues and therefore plays an important role in CNS sterol homeostasis and efflux (116).
- 27-hydroxycholesterol (27 OHC). It is synthesized in the liver and several non-hepatic cells by sterol 27-hydroxylase (CYP27A1). It is an intermediate in the alternative and bile acid synthesis pathway. 27 OHC is further oxidized by CYP27A1 to 3 $\beta$ - hydroxy-5-cholestenoic acid (117).
- 7 $\alpha$ -hydroxycholesterol (7 $\alpha$  OHC). It is also synthesized in the liver by cholesterol 7 $\alpha$ - monooxygenase (CYP7A1) and serves as an intermediate in the classic bile acid synthesis pathway (117).
- 4 $\beta$ -hydroxycholesterol (4 $\beta$  OHC). It is produced by a drug metabolizing enzyme taurochenodeoxycholate 6-alpha-hydroxylase (CYP3A4) in the liver and is induced in patients on certain anti- epileptic drugs (118, 119).
- 25-hydroxycholesterol (25 OHC). It is produced by cytochrome P450 enzyme. It is a regulator of the sterol regulatory element binding protein (SREBP) pathway for cholesterol dependant transcriptional regulation (112).
- 24(S), 25- epoxycholesterol. It is derived from a shunt of the mevalonic acid pathway of cholesterol biosynthesis (120).



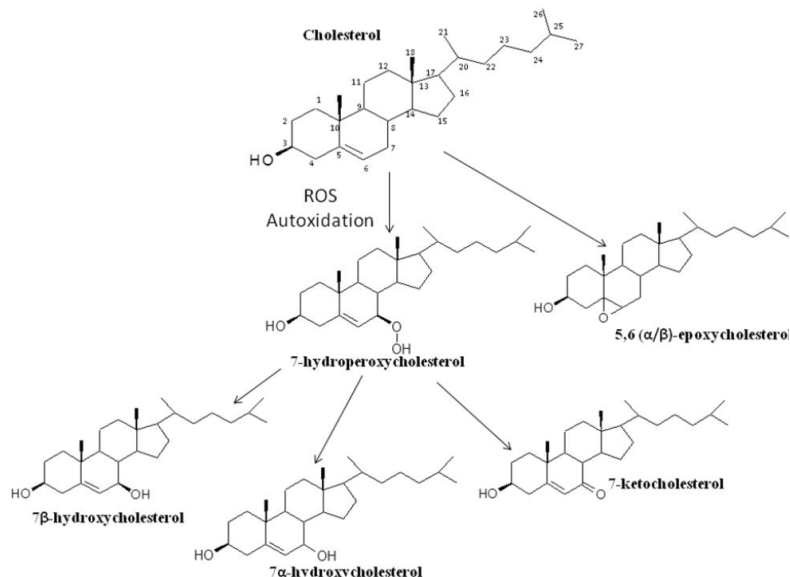
**Figure 2.7.** Structures and CYP enzymes of some enzymatically produced oxysterols  
(101)

### Non Enzymatic Oxidation

ROS such as hydroxyl radical can directly attack cholesterol leading to hydrogen elimination at the C7- location. The generated carbon centered radical further reacts with molecular oxygen and forms a cholesterol peroxy radical. This species recruits further nonoxidized lipids, starts a chain reaction to produce stable cholesterol hydroperoxides (121).

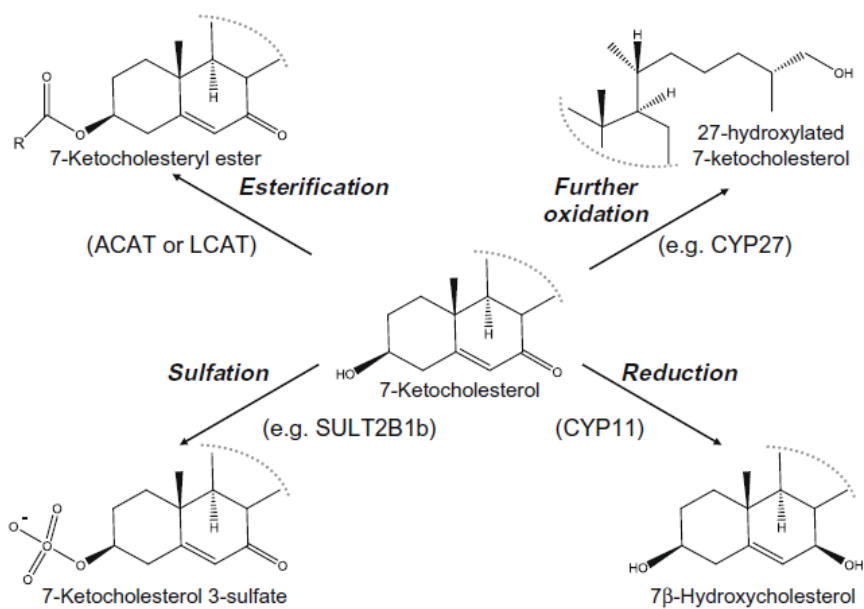


In existence of trace levels of transition metals, the hydroperoxides go through non-enzymatic breakdown and further reactions to make more stable hydroxy products like  $7\alpha$ -hydroxycholesterol ( $7\alpha$ OHC),  $7\beta$ -hydroxycholesterol ( $7\beta$  OHC) and 7-KC (122)(Figure 2-2). These oxysterols have important cytotoxic and pro-apoptotic properties (123)The epimeric 5,6( $\alpha/\beta$ )-epoxycholesterols may be produced by a non-radical reaction involving the non-enzymatic interaction of a hydroperoxide with the double bond. This process occurs in low-density lipoproteins (LDL) and macrophages (124).

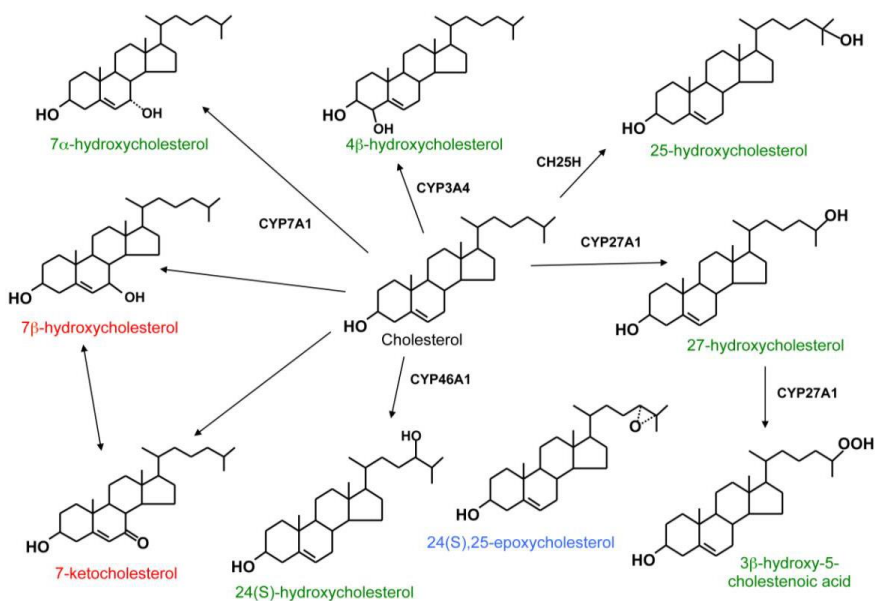


**Figure 2.8.** Structures and formation of some non enzymatically produced oxysterols

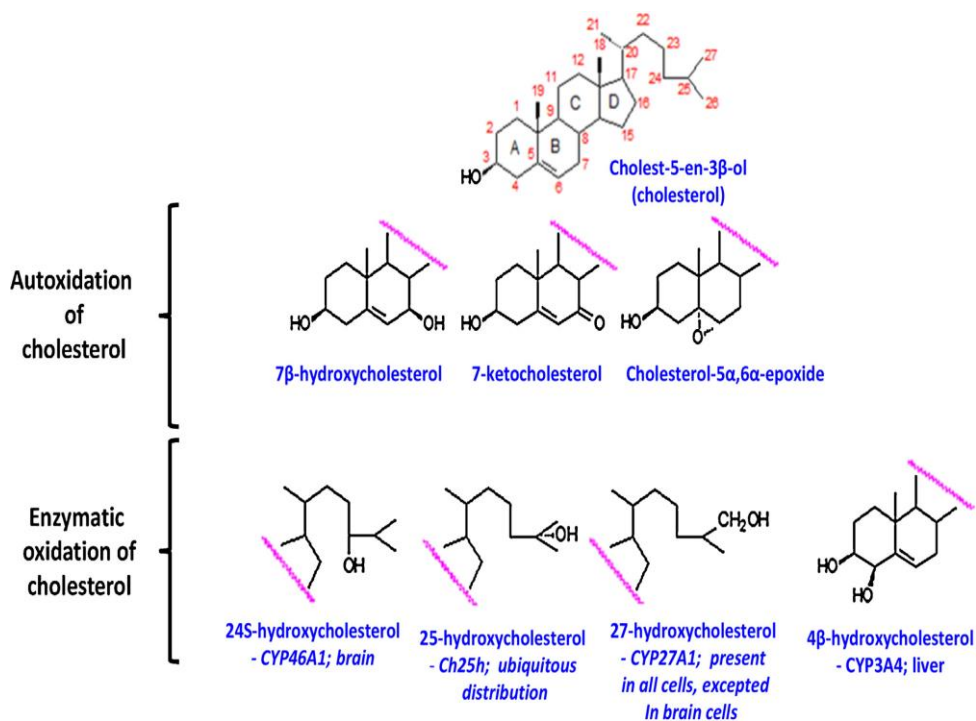
(101)



**Figure 2.9.** Structure and formation of some important oxysterols (101)



**Figure 2.10.** Structure and origin of selected common oxyster



**Figure 2.11.** Non enzymatic and enzymatic cholesterol oxidation products (103)

Furthermore, oxysterols are also present in a variety of foodstuffs due to lipid oxidation reactions caused by heating treatments, contact with oxygen and exposure to sunlight (125). Oxysterols exist, particularly in cholesterol-rich foods such as dairy products, eggs, dried egg powder, clarified butter, meat products, and dried fish (125, 126). They are absorbed in the gut and transported into the circulation within chylomicrons. These compounds absorbed more quickly in the intestines, compared to cholesterol. They have a faster plasmatic clearance, and they are quickly collected by tissues (127).

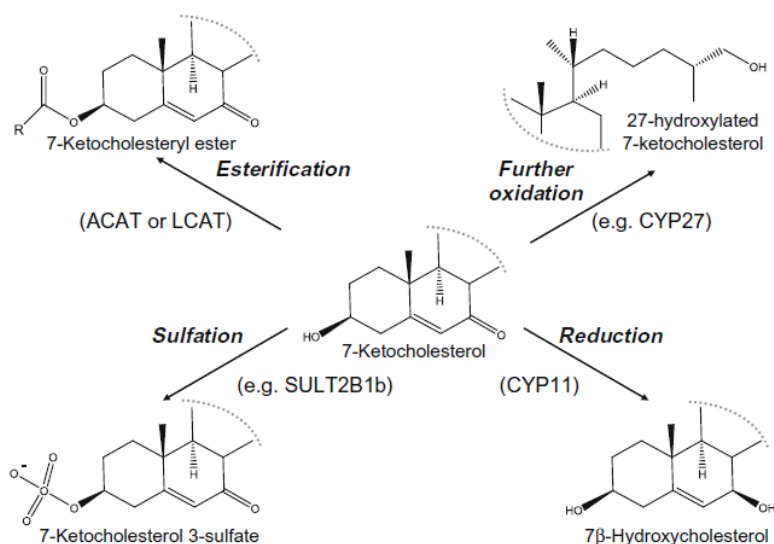
### 2.3.2. Cellular and blood Levels, Metabolism and Elimination of Oxysterols

Oxysterols can be found in the blood circulation within lipoproteins and in the cell membrane of healthy tissues at very low levels relative to a large excess of cholesterol (generally  $10^3$ - $10^6$  fold) (101, 107). We can find the highest levels of oxysterols in low density lipoproteins (LDLs) and to a lesser extent in high density lipoproteins (HDLs) and very low density lipoproteins (VLDLs) (128). Oxysterols are hydrophobic in nature like cholesterol and confined within cell membranes (101). Oxysterols have considerable effects on the membrane structure due to little structural differences relative to cholesterol (129).

In vivo oxysterols the same as cholesterol, are mainly present as esters with fatty acids. Lecitin cholesterol acyl transferase (LCAT) and Acyl CoA cholesterol acyl transferase (ACAT) are also responsible for esterification of oxysterols as well as overloaded cholesterol in cells and in circulation (130, 131). Oxysterols are present in mammalian tissues at very low concentrations (102). They have a shorter biological half-life than cholesterol and also be considered a way to route the cholesterol molecule for catabolism (102). Oxysterols can exit cells more easily due to their increased polarity relative to cholesterol. The first step of cholesterol metabolism is oxidation to an oxysterol (107). Precursors of cholesterol can also be oxidized to oxysterols (132). Most of the enzymatic pathways which metabolize cholesterol are also able to act on oxysterols (115). The main routes for oxysterol metabolism are shown in figure 2-12. Both ACAT and LCAT enzymes are efficiently esterify oxysterols in cells and plasma, respectively (101). Sterol 27-hydroxylase (CYP27A1) can act on cholesterol and several ring-oxygenated sterols (133).

For instance, CYP27A1 metabolizes 7-KC to 27- hydroxylated 7-KC which further metabolizes to water soluble metabolites which are less toxic and are more easily eliminated from the cell than 7-KC (133).  $11\beta$ -hydroxysteroid dehydrogenase type 1 ( $11\beta$ -HSD1 or CYP11b), another P450 enzyme, is best known for its role in oxysterol metabolism (108).

Sulfotransferases (SULTs) are a superfamily of enzymes, within which the SULT2 subgroup specifically sulfate the 3 $\beta$ -hydroxyl group of steroids and sterols. Several oxysterols are also substrates for the cholesterol sulfotransferase enzyme (134) and are changed to sulfate esters at the 3-hydroxyl group or at the side-chain by sulfotransferases or glucuronides for elimination (134, 135).



**Figure 2.12.** Modes of metabolism of oxysterols (136)

Oxysterol elimination is like cholesterol. They are eliminated directly from cells to lipophilic acceptors via membrane lipid transporters including ATP-binding cassette transporters, subfamily A or G, member 1 (ABCA1 or ABCG1) and by the as yet undefined efflux activity of scavenger receptor BI (SRBI) (137). Oxysterol synthesis is also an important part of steroid hormone and bile acid synthesis and important in the immune response to pathogens (106). The first step in steroid hormone biosynthesis is oxidation of cholesterol to 22R-hydroxycholesterol (22R-HC) and to 20R,22R-dihydroxycholesterol (20R,22R-diHC) and ultimately to pregnenolone by the enzyme CYP11A1 (138).

### 2.3.3. Physiological Activities and Biological Roles of Oxysterols

Oxysterols are biologically dynamic regulators of cholesterol biosynthesis through their action as ligands to nuclear receptors and G protein coupled receptors, in addition to signaling molecules involved in inflammatory and immune responses (102). Lipid-protein interactions are very important for the cellular activities of oxysterols particularly in the regulation of key proteins in the cholesterol metabolism (139). The physiological roles of steroid hormones in the body are well known. Oxysterols have steroidal structures and regulatory effects on cellular membrane interactions via receptor-ligand binding, activation of signal transduction and morphogenesis. These interactions can cause apoptosis induction as well as cytotoxicity (104, 140). In general, oxysterol actions can be divided into three different categories that include LXR membrane dynamics, protein interactions, and nuclear receptor binding (141). Oxysterols also regulate the functioning of the immune system (142). The innate immune system regulates adaptive immunity via oxysterols. Macrophage derived oxysterols suppress IgA production by B cells.

Upon activation of their toll-like receptors, macrophages also produce 25-hydroxycholesterol that is found in trace amounts in normal plasma (143). Oxysterols are associated with many physiological processes such as the regulation of cholesterol homeostasis (132, 144). They are also signaling molecules that maintain cellular and body lipid homeostasis and determine cell fate (102). These compounds can stimulate the differentiation of mesenchymal cells, monocytes, keratinocytes, lens epithelial cells, and osteoblasts (145, 146). Today it was well established that some oxysterols have damaging biological activities such as induction of cell death, pro-oxidative and pro-inflammatory activities (147, 148). Therefore, they can lead to the initiation and development of important diseases including neurodegenerative diseases. Some oxysterols, such as 7-KC and 7b-hydroxycholesterol are major components of oxidized low-density lipoproteins (oxLDLs) (114). Oxysterols are integrated into biological membranes, and different oxysterols have distinct impacts on membrane lipid packing (149, 150). Modification of membrane biochemical properties by oxysterols plays an

important role in cytotoxicity induced by these compounds (151). The physiological roles of some specific oxysterols are as intermediates in bile acid synthesis, in sterol transport between tissues and in the regulation of gene expression (101). Some oxysterols have important useful activities in osteogenesis, and are potent modulators of critical signalling pathways capable of preventing osteoporosis (152). Some studies report that oxysterols are potent inducers of apoptosis (153). Oxysterols can also induce necrosis or oncosis on various cell types (154, 155).

### **Role of Oxysterols in Cholesterol Homeostasis**

Oxysterols contribute considerably in keeping cholesterol levels under control by serving as sensors and regulators. 3-hydroxy-3-methyl glutaryl-CoA reductase (HMG-CoA reductase) is a principal enzyme in cholesterol biosynthesis (156). Oxysterols including 24(S), 25-epoxy cholesterol and 27 OHC speed up the HMG-CoA reductase degradation as a feedback regulation of high cholesterol levels (157).

SREBP is synthesized as an inactive precursor in the endoplasmic reticulum (ER) and is bound to SREBP cleavage activating proteins (SCAP) which acts as a sensor of cholesterol levels in the ER membranes. This pathway controls the cellular machinery for cholesterol biosynthesis and uptake (158). Low cellular cholesterol levels under a critical threshold are sensed by SCAP, which causes a change in conformation and escorts SREBP from the ER to the Golgi for proteolytic activation and ultimate activation of cholesterol biosynthesis. When levels of cholesterol and its oxysterol metabolites are adequate or elevated, the SCAP/SREBP complex is taken in the ER by insulin-induced gene Insig. It has been established that similar to cholesterol binding to SCAP, oxysterols, mainly 25 OHC and 24(S), 25-epoxycholesterol bind directly to Insig proteins (159). Liver X receptors (LXRs) are nuclear transcription factors that serve as a security regulator to limit free cholesterol in tissues that are experiencing high cholesterol fluctuations (160). Oxysterols play a critical role in cholesterol homeostasis

in the brain, which contains 25% of the whole body cholesterol, mainly in unesterified form. Cholesterol itself cannot cross the blood brain barrier and its efflux from the brain is brought about by conversion to 24 OHC (116, 161).

### **Role of Oxysterols in Signaling and Development**

It has been revealed that oxysterols are essential in the Hedgehog (Hh) signaling pathway which plays a critical role in embryonic development (162). Osteoinductive effects as well as inhibitory effects on differentiation of bone marrow stromal cells into adipocytes are shown by side chain oxygenated oxysterols like 20(S)-hydroxycholesterol and 22 OHC via activation of Hh signaling pathway (163, 164). Some cytoplasmic oxysterol-binding proteins (OSBPs) have been associated with lipid metabolism, cell signaling and vesicle transport (165).

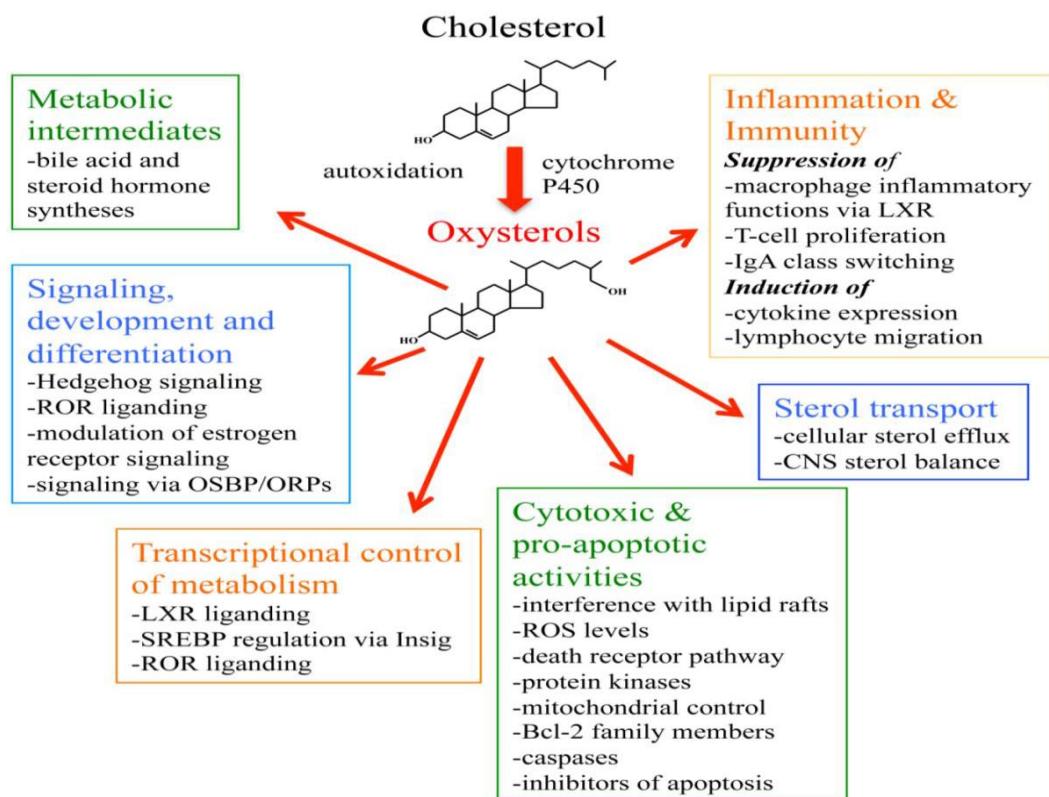
### **Role of Oxysterols in Inflammation and Immunity**

Some of oxysterols like 7-KC, 25 OHC and 7 $\beta$  OHC are reported to inspire proinflammatory signals and enhance inflammatory mediator expression like interleukin-8 (IL-8) and monocyte chemoattractant protein-1 (MCP-1) by macrophages and other cell types (166, 167). It has been shown that activation of LXR by endogenous oxysterols down-regulate the expression of interleukin-6 (IL-6), cyclooxygenase-2 (COX-2), inducible nitric oxide synthase and matrix metalloproteinase 9 (MMP-9) in macrophages (168, 169). Because of their association in several immune and inflammatory pathways, oxysterols have been suggested to involve in atherosclerosis lesion development and inflammation in metabolic disorders.



## Role of Oxysterols in Cytotoxic and Pro-apoptotic Activities

Oxysterols such as 25 OHC, 5 $\beta$ ,6 $\beta$  EC, 7-KC and 7 $\beta$  OHC are able to induce apoptosis by the two accepted pathways; mitochondrial (intrinsic) and the death receptor (extrinsic) pathways (123). Mitogen activated protein kinases (MAPKs) which are implicated in apoptosis and cytotoxic effects have been reported to be modulated by 7-KC and 5 $\beta$ ,6 $\beta$  EC (170). Oxysterols also implement cytotoxicity and apoptosis by interfering with lipid rafts, regulating the balance between pro- apoptotic Bak/Bax proteins and anti- apoptotic proteins of Bcl-2 family, and by inhibition of ROS (171, 172). A summary of physiological and pathological effects of oxysterols are shown in figure 2.13.



**Figure 2.13.** Physiological and pathological effects of oxysterol

#### 2.3.4. Methods for Oxysterol Analysis

Oxysterol analysis has been performed by several analytical techniques; however, there are a small number of reliable estimates of cellular and subcellular oxysterol levels. This is principally due to the complication related to making precise measurements of extremely low concentrations of oxysterols in biological samples in the presence of a large excess of cholesterol (173). Furthermore, in case of non-enzymatically produced oxysterols, even small amounts of cholesterol autoxidation throughout storage, sample preparation and analysis can make impressive changes in the levels of oxysterols being measured (174). An extra feature that has been ignored during oxysterol analysis is that oxysterols are mostly present as esters *in vivo*. With the above considerations, there are few dependable reports of *in vivo* oxysterol levels (175).

Levels of oxysterols have been analyzed using conventional techniques such as thin layer chromatography (TLC) and high performance liquid chromatography (HPLC) with UV detection which are useless owing to the presence of high background cholesterol. TLC is an easy technique which can be employed for the separation of synthetic reaction mixtures (107). Complicated mixtures of oxysterols have been separated using HPLC however low analyte levels and absence of a strong chromophore in most oxysterols makes UV detection not sensitive enough to measure biological levels of oxysterols (176). Complex liquid chromatography methods involving enzymatic alteration of oxysterols to yield stuffs having better UV absorbance have been developed (177). In the last years, mass spectrometry methods have been favored over the usual techniques due to their capability to solve the problems of isomeric variation between oxysterols and high cholesterol background (178). Gas chromatography mass spectrometry (GC-MS) was the earliest and widely used method for oxysterol estimation.

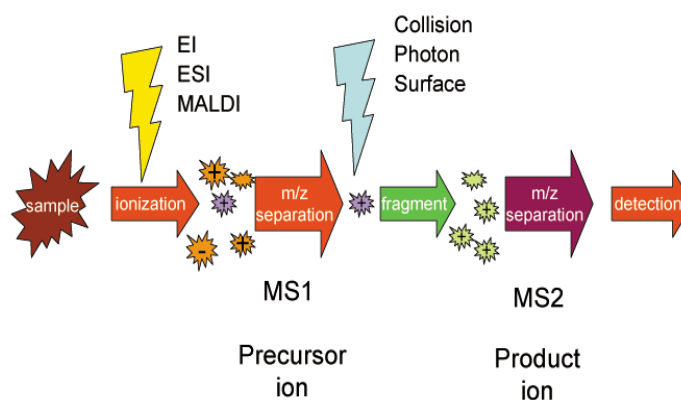
The GC-MS methods involve complex sample extraction steps, including saponification for the release of free forms of esterified oxysterols, solid phase extraction (SPE) followed by derivatization of multiple functional groups prior to analysis (179). GC-MS techniques have provided attractive findings on oxysterols however, their labor exhaustive, time consuming nature momentum for liquid chromatography-mass spectrometry (LC-MS) and liquid chromatography-tandem mass spectrometry (LC-MS/MS) method developments. Several LC-MS and LC-MS/MS studies of oxysterols have been carried out.

The most significant benefit of these techniques over GC-MS is that derivatization of the analyte to a volatile form is not a prerequisite (167). The fundamental sample preparation of LC-MS/MS analysis depends on whether the target is free or total oxysterol. More than 70% of most oxysterol compounds in human plasma are esterified to fatty acids, so the majority of methods has focused on total levels. Since cholesterol is present in blood plasma at more than 1000X higher concentrations than most oxysterols, even 0.1% oxidation can lead to huge increases in oxysterols levels (178,180).

Subsequent of LC separation oxysterols can be also analyzed by means of either the electrospray ionization (ESI) or atmospheric pressure chemical ionization (APCI) methods (181-183). The ESI method was the first LC-MS interface to be applied, but has been mainly replaced with the initiation of the APCI interface which demonstrates better ionization (142). A major complexity and difficulty of LC-MS/MS analysis is that some groups of oxysterols are isobaric compounds with the identical molecular ion which have the propensity to give similar mass spectra. This makes the recognition of unknowns difficult and necessitates the need for chromatographic resolution of oxysterol isobars prior to MS detection (142).

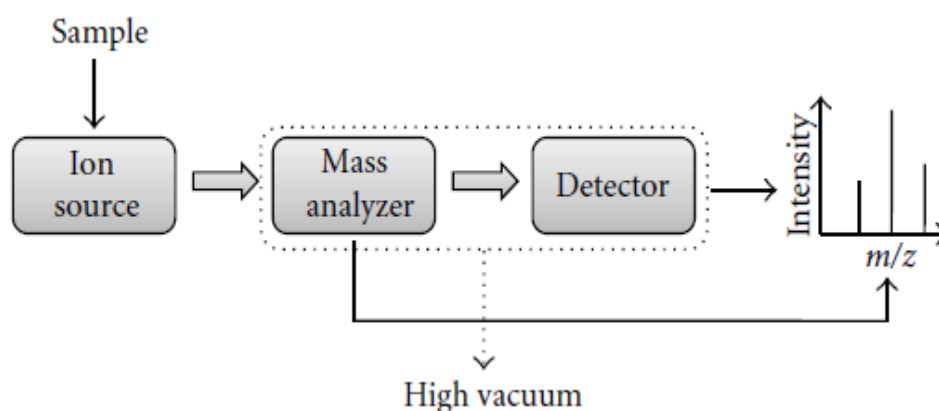
## 2.4. Liquid chromatography- Tandem mass spectrometry (LC-MS/MS)

Liquid chromatography-mass spectrometry- mass spectrometry (LC-MS/MS), is a sensitive analytical technique used for the separation, recognition and quantitation of different compounds in one sample. This technique involves the interfacing of a powerful separation method, high performance liquid chromatography (HPLC) with a great and powerful detection method of mass spectrometry- mass spectrometry (MS/MS). High specificity and sensitivity coupled with the ability to handle complex mixtures makes LC-MS/MS a highly precise method in laboratories for different compounds such as protein, peptide, and oligonucleotide analysis, drug discovery and clinical drug testing. Following separation by the LC system, mass spectrometers work by first converting the analyte molecules into an ionized state by an ion source. Ionization is accomplished within the system interface which nebulizes the sample solvent, charges the droplets and then desolvates the charges particles generating ionized analytes. The ions are further separated and analyzed according to their mass to charge ( $m/z$ ) ratio in a mass analyzer and are then quantified by the detector. The output is in the form of a mass spectrum, which is a plot of the abundance of the produced ions as a function of the  $m/z$  ratio (184, 185) (Figure 2-16.3-1).



**Figure 2.14.** Schematic diagram showing working of MS/MS

The ion source serves to ionize the analyte molecule into molecular ions and separate them from the mobile phase. The Atmospheric Pressure Ionization (API) and Electrospray ionization (ESI), are the most commonly used ionization techniques. Atmospheric pressure chemical ionization (APCI), and Atmospheric pressure photoionization (APPI) are also available. The other ionization methods include Matrix-assisted laser desorption (MALDI) and Fast Atom Bombardment (FAB). The ionization technique used in this thesis is the ESI.



**Figure 2.15.** The basic components of mass spectrometer.

#### 2.4.1. The Mechanism of Electrospray Ionization

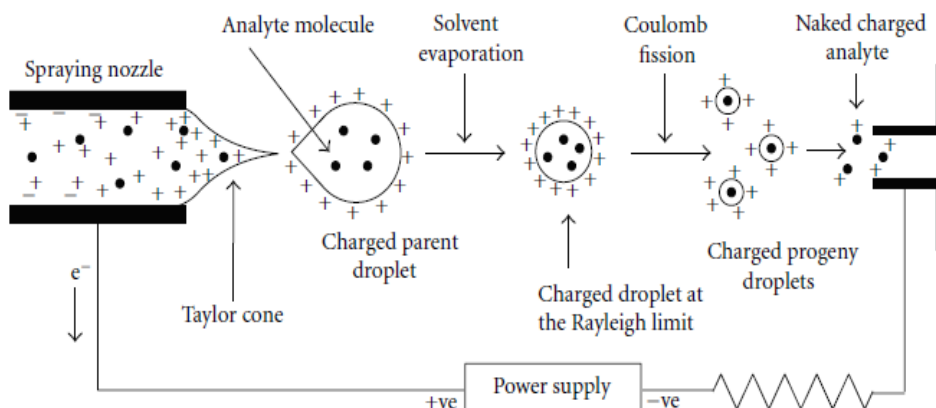
When an analyte is transferred from solution to the gas phase via ESI, the analyte solution undergoes three major processes. These are (a) production of the charged droplets from the high-voltage capillary tip where the analyte solution is injected; (b) repeated solvent evaporation (from the charged droplet) and droplet disintegration. It results a very small charged droplet, which is able to produce the charged analyte; (c) finally a mechanism by which the gas-phase ion is formed (186) (Figure 2-16).

**A) Production of Charged Droplets;** When the analyte solution is pumped through the high-voltage capillary (emitter), an electrochemical reaction of the solvent occurs which causes an electron flow to or from the metal capillary depending on its polarity (187). In the absence of any redox active analyte, the oxidation of the solvent occurs in the positive ion mode and reduction of the solvent occurs in the negative ion mode (188, 189). These redox reactions provide positive or negative ions in the solutions depending on the polarity of the emitter electrode. Generally polar solvents such as water, methanol, acetonitrile which simply go through electrochemical reactions in the spraying nozzle, are used in the ESI-MS experiments (189).

**B) Coulomb Explosion and Disintegration of the Charged Droplets;** The charges in the droplets are spread on its surface with central spacing to minimize the potential energy (190). There are two forces acting in opposite directions in the charged droplets. One is surface tension of the charged droplet, which tries to keep the spherical shape of the droplet, and the other is coulomb force of repulsion among the like charges on the surface, which tries to break down the circular shape of the charged droplet (191). The solvent evaporation happens when the droplets cross the space among spraying nozzle and the heated capillary. Accordingly the mass and the size of the droplet decreases until it reaches the point (192).

**C) Formation of Gas-Phase Analyte Ions from the Charged Droplets;**

Two standard mechanisms involving charge residue model and ion evaporation model have been planned to account for the structure of gas-phase analyte ions from very small highly charged ES droplets, and those are charge residue model (CRM) (193).



**Figure 2.16.** Schematic representation of the electrospray ionization process (186)

### 2.4.2. Mass Spectrometry

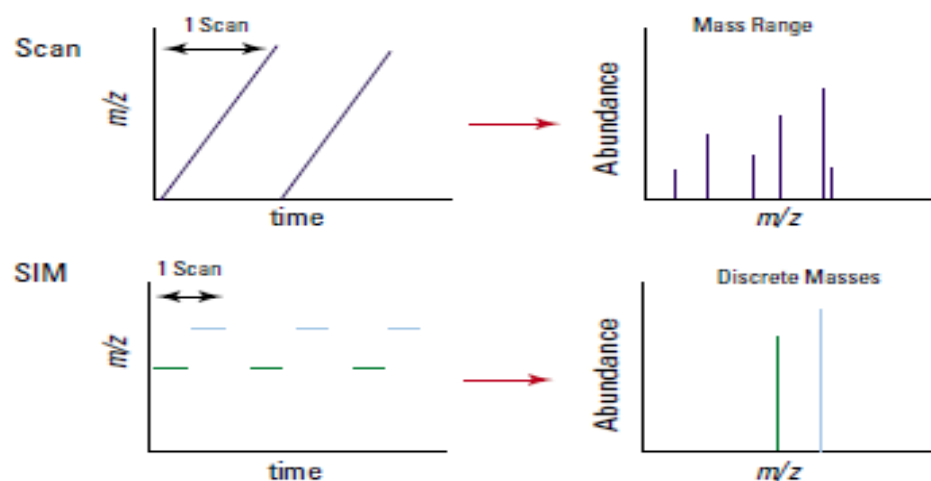
During the last decades mass spectrometry has progressed rapidly. Mass spectrometry's characteristics have raised it to an outstanding position among analytical methods due to its detection limits, unequalled sensitivity, speed and diversity of its applications (194). Mass Spectrometry is an analytic technique that utilizes the degree of deflection of charged particles by a magnetic field to find the relative masses of molecular ions and fragments. Mass spectrometry is based upon the motion of a charged particle, called an ion, in an electric or magnetic field. The mass to charge ratio ( $m/z$ ) of the ion effects this motion (195). The first step in the mass spectrometric analysis of compounds is the production of gas-phase ions of the compound, by electron ionization. The molecular ion normally undergoes fragmentation and the mass spectrum of the molecule is produced. It provides this result as a plot of ion abundance versus mass-to-charge ratio. There are four types of mass analyzer that could be used for LC/MS. These are: quadrupole, time-of-flight, ion trap and fourier transform-ion cyclotron resonance (FT-ICR or FT-MS). Each has disadvantages and advantages depending on the requirements of a particular analysis.

A quadrupole mass analyzer consists of four parallel rods arranged in a square. The analyte ions are directed down the center of the square. The voltages applied to the rods generate electromagnetic fields. These fields determine which mass-to-charge ratio of ions can pass through the filter at a given time. Quadrupoles tend to be the simplest and least expensive mass analyzers (196).

Quadrupole mass analyzers can operate in two modes:

- Scanning mode
- Selected ion monitoring (SIM) mode

In scan mode, the mass analyzer monitors a range of mass-to-charge ratios. In SIM mode, the mass analyzer monitors only a few mass-to-charge ratios. SIM mode is significantly more sensitive than scan mode, but provides information about fewer ions (196). Scan mode is typically used for qualitative analyses or for quantitation when all analyte masses are not known in advance. SIM mode is used for quantitation and monitoring of target compounds.

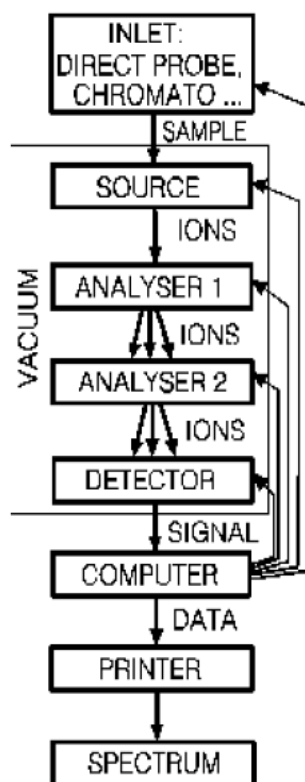


**Figure 2.17.** The quadrupole mass analyzer can scan over a range of mass-to-charge ratios



### Diagram of a Mass Spectrometer

A mass spectrometer always contains the following elements, as illustrated in Figure 18. A sample inlet to introduce the compound that is analysed, an ionization source to produce ions from the sample, one or several mass analysers to separate the various ions, a detector to 'count' the ions emerging from the last analyser, and finally a data processing system that produces the mass spectrum in a suitable form.



**Figure 2.18.** Basic diagram for a mass spectrometer with two analysers and feedback control carried out by a data system.

Some of the key terms and abbreviations;

**Analyte:** A specific chemical moiety being measured, which includes intact drug, biomolecule or its derivative, metabolite, and/or degradation product in a biologic matrix.

**Analytical run (or batch):** A set of analytical and study samples with appropriate number of standards and QCs for their validation.

**Biological matrix:** A distinct material of biological origin including blood, serum, plasma, urine, feces, saliva, sputum, and various discrete tissues.

**Quality control (QC) sample:** A spiked sample used to monitor the performance of a bioanalytical method and to assess the integrity and validity of the results of the unknown samples analyzed in an individual batch.

**Internal standard (IS):** Test compounds that structurally similar analog or stable isotope labelled compound which added to calibration standards, QCs and unknown samples at a known and constant concentration to facilitate correction for experimental variability during sample preparation and analysis.

**Calibration/Standard Curve (Linearity):** The relationship between instrument response and known analyte concentrations is called as calibration curve. For a multi-analyte study, for each analyte a calibration curve should be generated. The calibration standards should be prepared in the same matrix as the intended samples under study. The number of standards used for constructing a calibration curve depends on the probable range of analytical values and the nature of the analyte/response relationship. A calibration curve should consist of a blank matrix sample processed without internal standard, a blank matrix sample processed with internal standard, and five to eight non-zero standard points covering the expected range or analyte concentration.

### 3. Materials and Methods

#### 3.1. Chemicals

1.  $3\beta$ -hydroxy-5-cholestene-7-one-d7 (7 ketocholesterol-D7), (Avanti, Catalog No T700046P)
2.  $3\beta$ -hydroxy-5-cholestene-7-one (7 ketocholesterol), (Avanti, Catalog No 700015P)
3.  $3\beta,5\alpha,6\beta$ - Trihydroxycholestane, (Toronto, Catalog No T795100)
4.  $3\beta,5\alpha,6\beta$ - Trihydroxycholestane,D7, (Toronto, Catalog No T795102)
5. N-(3-Dimethyl Amino Propyl)-N'- ethyl Carbodiimid Hydrochloride (EDC) (Sigma, E1769)
6. N,N-Dimethylglycine hydrochloride (DMG) (Sigma, D6382)
7. 4-(Dimethylamino) pyridine, Reagent Plus, (DMAP) (Sigma,107700)
8. Chloroform, Chromasolv<sup>(R)</sup> Plus, for HPLC,  $\geq 99.9\%$ , Contains 0.5-1.0% Ethanol as stabilize (Merck)
9. Hexane Chromasolv<sup>(R)</sup> for HPLC,  $>97.0\%$  (Merck)
10. Methanol Chromasolv<sup>(R)</sup>, Gradinet Grade, for HPLC,  $>99.9\%$  (Merck)
11. Human Recovered Plasma, Charcoal-Dextran Stripped Anticoagulants available: (ACD, EDTA, Heparin)-UNIT, Sterile Filtered, (Frozen) (Zenbio, Catalog No SER-PLE-CDS)
12. Formic acid LC-MC Ultra, eluent additive for UHPLC-MS (Sigma, Catalog No 56302 Fluka )
13. Ammonium formate for HPLC,  $\geq 99.0\%$  (Sigma, Catalog No,17843)
14. Acetonitrile, LC-MS Ultra Chromasolv<sup>(R)</sup> (Sigma, Catalog No, 34967)

### **3.2. Equipment and Instruments**

1. LC-MS/MS (Shimadzu model 8040)
2. Ependorf centrifuge (Abott)
3. Water bath (Nuve B5)
4. HPLC Glass inserts (Sigma)
5. Centrifuge (Labofuge 200 Heraeus)
6. Evaporator (Univapo 150 H)
7. Vaccum fornace (Kendro B6420)
8. Glass test tubes (10 ml) (Fisher Scientific)
9. Orbital shaker (Heidolph tetramax 101)
10. LC-MS/MS Column, Symmetry C18 (3-5 $\mu$ m, 21\*50 mm) (WAT 200650)
11. Precision scale (Shimadzu ATX 224)

### **3.3. Study Groups**

Eighty type 2 and 26 type 1 diabetic patients who were referred to Hacettepe University, Faculty of Medicine, Department of Internal Medicine, Endocrinology Unit, were enrolled for the study. A detailed interview addressing personal, family history, demographic information and physical examination was performed. One hundred twenty six healthy controls were also included into the study. The individuals with chronic inflammatory and metabolic diseases, Alzheimer's, and hepatic disorders were excluded. The study protocol adhered to the Declaration of Helsinki Guidelines and was approved by the Ethics Committee of Hacettepe University (GO 15/662). All patients provided written informed consent.

### **3.4. Sample collection**

Blood samples were obtained from patients with a confirmed diagnosis of type 1 and type 2 DM. Bloods were collected in ethylenediaminetetraacetic acid dipotassium salt (EDTA-K<sub>2</sub>) containing tubes. Blood samples were transferred to the Clinical Pathology Laboratory of Hacettepe University Hospitals on ice within 10-15 minutes. The samples were centrifuged at 13000 rpm for 10 minute and plasma were collected and then immediately stored at -80°C.

### **3.5. Measurement of biochemistry profiles**

Biochemical characteristics of the patients were measured in the morning after 12 h of fasting. The biochemistry profiles measured by Beckman Coulter AU 680, and special kits and reagents for each biochemical parameters. HbA1c was measured by HPLC (Shimadzu DGU-20A 3R). The intra-assay coefficient was 0.9% and the inter-assay coefficient was 2.2%.

### **3.6. Oxysterol Analysis**

The oxysterol analysis was performed by using LC-MS/MS system (Shimadzu Scientific Instruments, 8040). The plasma levels of cholestan-3 $\beta$ ,5 $\alpha$ ,6 $\beta$ -triol and 7-ketokolesterol were measured. The LC system consists of two, dual head, LC10 ADVp high pressure solvent pumps joined by a high pressure mixing tee, a DGU 14A solvent degassing unit, a SIL 20A autosampler, a CTO column oven and an in series SPDM10A photodiode array (PDA detector). The mass spectrometries were connected in series with a 2010A single quadrupole detector with interchangeable ESI. The system is controlled via a computer. Nitrogen supply for the MS detector was provided by a regulated venting from a liquid nitrogen tank.

### 3.6.1. Optimization of Chromatographic Conditions and Mobile Phase Gradient

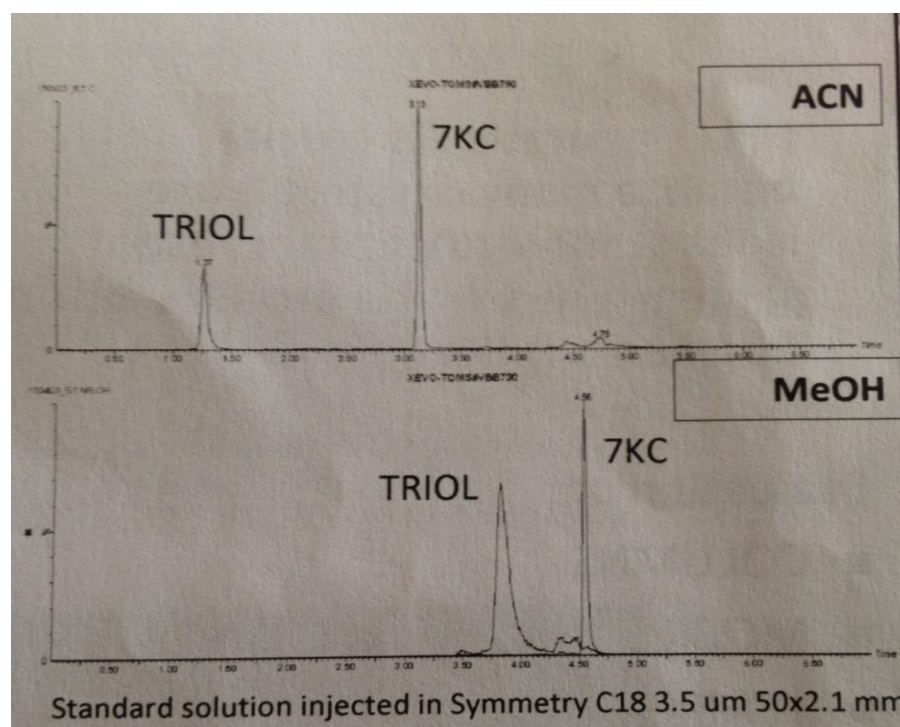
HPLC separation is crucial because many oxysterols are isobaric molecules that present same precursor and product ion fragments. For optimization of LC method evaluation of columns, mobile phases, additives and temperature are necessary. Optimum flow rate and mobile phase gradient was searched for achieving the highest resolution between peaks for 7-KC and cholestan-3 $\beta$ ,5 $\alpha$ ,6 $\beta$ -triol, to obtain a better separation. Efficient evaluation of flow rate, percentage of ACN (at the beginning and during the gradient) and temperature of column oven was carried out by altering one parameter at a time, in order to decide upon the combination which gave best chromatographic resolution.

There are two kinds of columns used in this method; normal phase column and reverse phase column. Normal phase column provides good separation, but low reproducibility of oxysterol species (non derivatized) and it is sensitive to pH changes. The reverse phase column is suitable for derivatized oxysterols. After derivatization, the polar group attached increases the hydrophilicity of the molecules changing the retention properties of the molecule in the column. The column that was selected for this analysis was a reverse phase column, Symmetry C18 (3-5 $\mu$ m, 21\*50 mm) (C/N 5020-01742) (Sigma Aldrich, St.Louis, MO). Reverse phase column achieved a good separation of these molecules. Methanol (MeOH) and acetonitrile (ACN) are commonly used for separation of different molecules in LC method. MeOH is suggested for steroids and it is more polar compared to ACN. However, ACN achieves a better separation compared to MeOH (Figure 3-1). MeOH induces high back pressure in the column. In addition, prediction of retention time with MeOH is so difficult. The mobile phase consisted of two solvents: Solvent A and Solvent B.

Mobile phase:

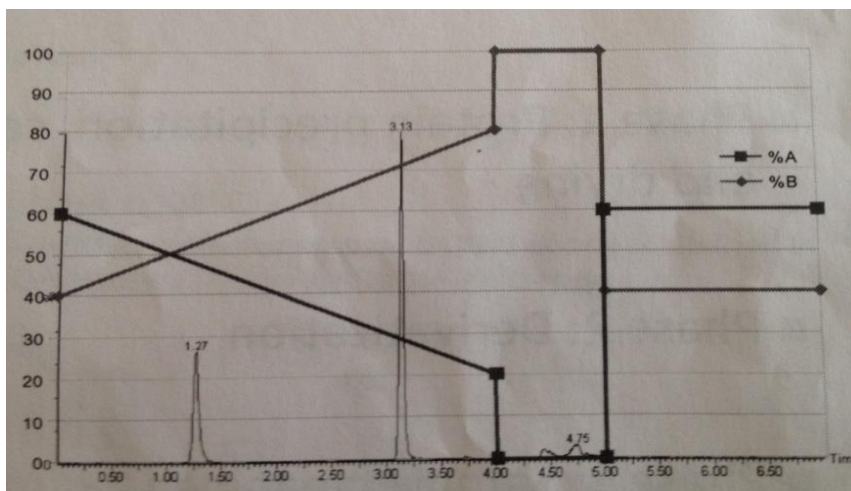
- Solvent A:(1 mM ammonium formate, pH= 3)
- Solvent B: Acetonitrile; ACN:1 mM ammonium formate (95:5) , pH=3.

To prepare 1 mM ammonium formate, 63 mg ammonium formate was dissolved in 1 L water and the pH was adjusted to 3 by formic acid. For preparation of mobile phase B, we mix 50 mL of mobile phase A with 950 mL ACN and after that pH was adjusted to 3 by formic acid.

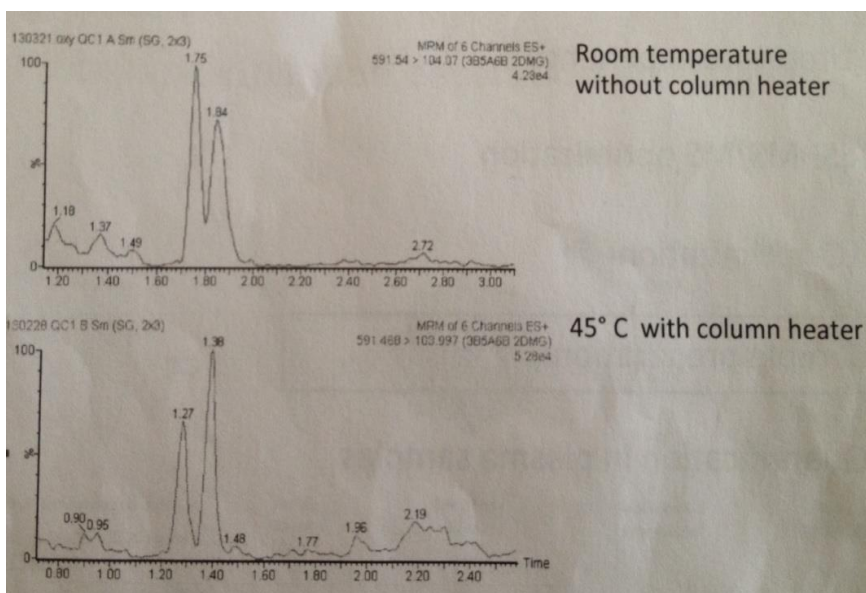


**Figure 3.1.** Separation with ACN in contrast with MeOH.

The mobile phase consisted of Solvent A and Solvent B. The chromatographic run was performed with a gradient that is shown graphically in Figure 3-2.



**Figure 3.2.** Linear gradient representation of mobile phases used during sample analysis. The column oven temperature was maintained at 45°C. This temperature provides a better separation in contrast to room temperature (Figure 3-3)



**Figure 3.3.** Separation of a plasma sample with and without a column heater.

The sample injection volume was 7.5  $\mu\text{L}$  and the total run time was 7 minutes per sample. Optimized HPLC parameters are shown in table 3-1.



**Table 3.1.** The HPLC parameters

Parameter	Value	Setting	Units
Total Flow	Binary gradient	Binary gradient	mL/min
Pump A pressure	115	-	bar
Pump B pressure	112	-	bar
Pump A Degassing	-94	-	kPa
Oven Temperature	45	45	C
Nebulizing Gas Flow	3.0	3.0	L/min
Drying Gas Flow	15.0	15.0	L/min
DL Temperature	250	250	C
Heat Block Temperature	450	450	C
CID Gas	230	230	kPa
Room Temperature	29	-	C
IG Vacuum	1.4e -	003	Pa
PG Vacuum	7.3e +	001	Pa

### 3.6.2. Preparation of Solutions

- Stock Solutions of Standard:

Stock solutions of 7-KC and cholestan-3 $\beta$ ,5 $\alpha$ ,6 $\beta$ -triol were prepared (1mg/mL) by dissolving the powdered form of the standards in HPLC grade methanol. Stock solution of 7-KC and cholestan-3 $\beta$ ,5 $\alpha$ ,6 $\beta$ -triol was diluted 1:200 using HPLC grade methanol and water to prepare an intermediate stock concentration. All stock standards were stored at -20°C.

- Working standard solution: Working solution of internal standard was prepared from the intermediate stock. 10 $\mu$ g/mL of cholestan-3 $\beta$ ,5 $\alpha$ ,6 $\beta$ -triol-d7 and 10 $\mu$ g/mL of 7-KC-d7 was prepared in methanol (IS).
- Calibration Standard Working Solutions: Commercial human plasma defibrinated and delipized diagnostic grade plasma was used for preparation of calibration standards. Calibration curves were generated for two oxysterols; 7-KC and cholestan-3 $\beta$ ,5 $\alpha$ ,6 $\beta$ -triol. The calibration range was decided based on approximate biological levels of the oxysterols in a normal healthy human and

pathological levels in Niemann-Pick type C disorder where oxysterols are observed very high and used as biomarkers of this disease. A primary mixture of 8 calibration standards (8-Mix calibrator) was prepared from the stock solutions of the standards as shown in Table 3.2. These standard calibrators prepared by single additions of intermediate stock solutions. After preparation standards were aliquotated and stored at  $-80^{\circ}\text{C}$ .

**Table 3.2.** Preparation of calibration standard working solutions (in 1 L)

Calibrators	7-KC and cholestan, $3\beta,5\alpha,6\beta$ -Triol 5000 ng/mL	7-KC and cholestan, $3\beta,5\alpha,6\beta$ -Triol 500 ng/mL	7-KC and cholestan $3\beta,5\alpha,6\beta$ -Triol 50 ng/mL	7-KC and cholestan $3\beta,5\alpha,6\beta$ -Triol 50 ng/mL
CAL 1	3.125 ng/mL	-	-	62.5 mL
CAL 2	6.25 ng/mL	-	12.5 mL	-
CAL 3	12.5 ng/mL	-	25 mL	-
CAL 4	25 ng/mL	-	50 mL	-
CAL 5	50 ng/mL	-	100 mL	-
CAL 6	100 ng/mL	20 mL	-	-
CAL 7	200 ng/mL	40 mL	-	-
CAL 8	400 ng/mL	80 mL	-	-

- Preparation of Quality Control Samples

Quality control (QC) samples were prepared with pooled plasma samples to establish the mean concentration of endogenous cholestan-3 $\beta$ ,5 $\alpha$ ,6 $\beta$ -triol and 7-KC by the LC-ESI-MS/MS method. The low, and high plasma quality control (LQC, HQC) samples were prepared by spiking known amounts of standards of cholestan-3 $\beta$ ,5 $\alpha$ ,6 $\beta$ -triol and 7-KC to yield an endogenous level 40/40 ng/mL and endogenous level 150/150 ng/mL, respectively. A primary 2 mix of QC samples was prepared identically, but separately from the stock solutions of the standards. After preparation of QC samples they were aliquoteted in ependorf tube and stored at -80 °C.

### 3.6.3. Sample Preparation

Sample preparation consists of three phases. Phase 1 includes three steps, protein precipitation, separation and drying. Phase 2 is derivatization phase and phase 3 is sample cleaning. Study samples, QCs and standards, were aliquotted into 2 ml ependorf tubes. The LC-MS/MS assay was designed only to measure free or unesterified oxysterols, saponification of plasma samples during sample preparation, which is necessary for measurement of total oxysterol species, was not required. Removal of this step avoids the identified degradation of oxysterols that happen during the alkaline hydrolysis procedure and the possibility for overestimation of total oxysterol concentrations. There are a variety of different protocols for the preparation in literature, we used the protocol developed by Xuntian Jiang et al (197).

Phase 1; For calibration standards, QC samples and diabetic patient plasma samples, 50  $\mu$ L of sample was added to a 2mL ependorf tube. Internal standard working solution (300  $\mu$ L, 20 ng/mL) was added to all samples, except blank matrix samples to which 250  $\mu$ L of MeOH was added. Ependorf tubes were vortexed for 30 seconds, and then centrifuged for 10 min at 13000 rpm at room temperature. After centrifugation, the

supernatants were transferred to clean 2 mL ependorf tubes, then the organic layer was evaporated to dryness at 35°C in a Multi-Well Evaporation Systems (Univapo 150).

Phase 2; This phase is called the derivatization phase. Twenty  $\mu\text{L}$  of 0.5 M DMG/2M DMAP in chloroform and 20  $\mu\text{L}$  of 1M EDC in chloroform were added to the extracted samples. After that mixtures were capped and vortexed, then heated for 1 h at 45°C in a water bath. After the water bath the color of ependorfs should be dark yellow. This color shows that we have a good derivatization. Two hundred fifty  $\mu\text{L}$   $\text{H}_2\text{O}$  and 500  $\mu\text{L}$  hexane were added to the derivatized samples, and samples were shaken on an orbital shaker for 5 minutes at 1000 rpm

The samples were centrifuged for 10 min at 13000 rpm at room temperature. Five hundred  $\mu\text{L}$  hexane were added on to the supernatant The samples were shaken on an orbital shaker for 5 minutes at 1000 rpm. The samples were again centrifuged for 10 min at 13000 RPM. The supernatants (hexane) were evaporated. After evaporation 300  $\mu\text{L}$  %80 MeOH were added. The samples were vortexed for 20 seconds and transferred into 1.5 mL HPLC autosampler vials with 0.25 mL limited volume conical vial inserts and subject to analysis on the LC-MS/MS.

Phase 3; It is a sample cleaning phase by LC. This step do not increase the signal in MS/MS but reduce the dirty on source cone.

### 3.6.4. Optimization of MS/MS Source Settings

The mass spectrometry conditions involved the ESI interface in positive ion mode and selective ion monitoring (SIM) was chosen. The optimized parameters are summarized below in Table 3.3.

**Table 3.3.** Mass spectrometric parameters

Parameter	Optimized set value
IG vacuum	1.4e -
Detector voltage	0.0 kV
Temperature Limit	85°C
DL temperature	250°C
Nebulizing gas flow	3.0 L/min
Heat block	450 °C

For increasing mass spectrometry detection of cholestan-3 $\beta$ ,5 $\alpha$ ,6 $\beta$ -triol and 7-KC, the oxysterols were changed into DMG esters. Introduction of the DMG improved dissociation efficiency in Q2 quadrupole (collision cell), greatly enhancing the overall response for the oxysterols. The multiple reaction monitoring (MRM) mass transitions of 7-KC and cholestan-3 $\beta$ ,5 $\alpha$ ,6 $\beta$ -triol were shown in table 3.4.

m/z of DMG esters of 7-KC and cholestan-3 $\beta$ ,5 $\alpha$ ,6 $\beta$ -triol in M<sup>+</sup>H<sup>+</sup> were 486.0 and 591.5, respectively. m/z of 7-KC D7 and cholestan-3 $\beta$ ,5 $\alpha$ ,6 $\beta$ -triol D7 in M<sup>+</sup>H<sup>+</sup> were 493.0 and 598.5, respectively. Product ions were as follows:

- m/z 104: protonated DMG
- m/z 383: oxysterol fragment resulting from loss of DMG
- m/z 488.5: oxysterol fragment resulting from loss of DMG

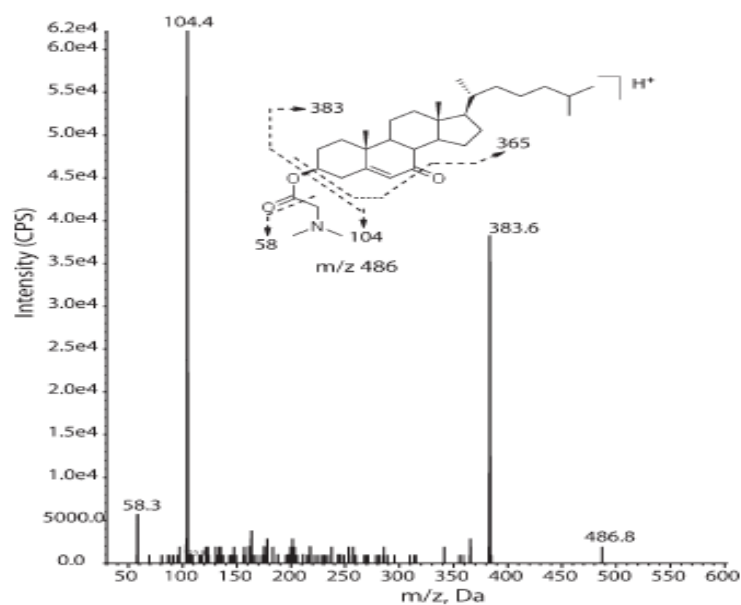
**Table 3.4.** Mass transitions of 7-KC and cholestan-3 $\beta$ ,5 $\alpha$ ,6 $\beta$ -triol

DMG derivatives	Parent ion	Product ion
7-KC	486.0	104
	486.0	383
7-KC D7	493.0	104

Cholestan-3 $\beta$ ,5 $\alpha$ ,6 $\beta$ -triol	591.5	104
	591.5	488.5
Cholestan-3 $\beta$ ,5 $\alpha$ ,6 $\beta$ -triol D7	598.5	104

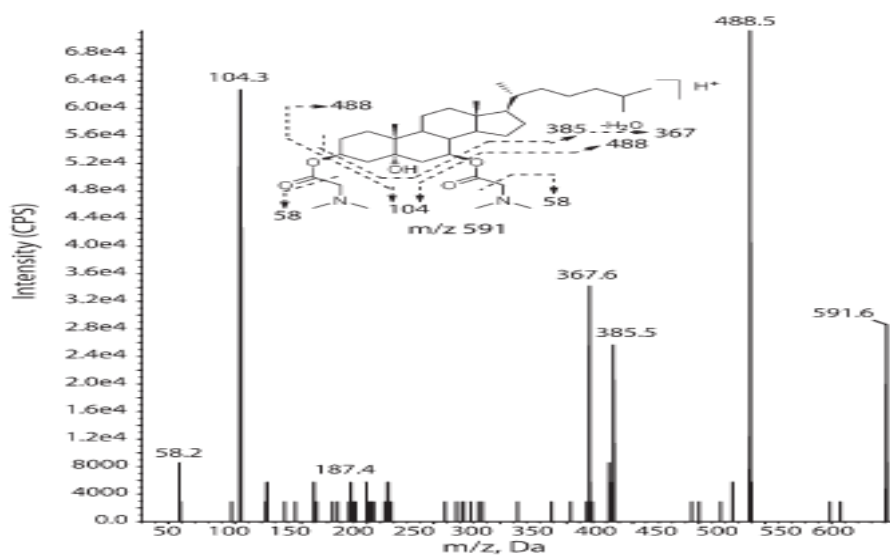
The MRM mass transitions for oxysterol-DMG derivatives were  $m/z$  591.5  $\rightarrow$  104 (quantifier) and 591.5  $\rightarrow$  488.5 (qualifier) for cholestan-3 $\beta$ ,5 $\alpha$ ,6 $\beta$ -triol and  $m/z$  486  $\rightarrow$  383 (quantifier) and 486  $\rightarrow$  104 (qualifier) for 7-KC.

Figure 3.4. shows the product ion spectra and fragmentation patterns of DMG derivatives of 7-KC with collision.



**Figure 3-4.** Product ion spectra and fragmentation pattern of DMG derivative of 7-KC. (197)

Figure 3.5. shows the product ion spectra and fragmentation patterns of DMG derivatives of cholestan-3 $\beta$ ,5 $\alpha$ ,6 $\beta$ -triol with collision.



**Figure 3-5.** Product ion spectra and fragmentation pattern of DMG derivative of cholestan-3 $\beta$ ,5 $\alpha$ ,6 $\beta$ -triol (197)

### **3.6.5. Precision, Accuracy and Sensitivity**

Within-run accuracy and precision were determined by analyzing two replicates of QC samples at two levels, including LQC and HQC for each analyte along with a set of calibrators. Accuracy was expressed as percent deviation from the nominal concentration and precision was expressed in terms of percent coefficient of variation (CV%). Between-run precision and accuracy was determined by replicating the above 'within-run' analysis on different days. Precision was considered acceptable if the interpolated concentration at each QC level was within 15% of nominal value, except for the LLOQ, where it could be less than 20% of the nominal. The acceptance criteria for precision was that at each concentration level, % CV should not exceed 15%.

### **3.7. Statistical Analyses**

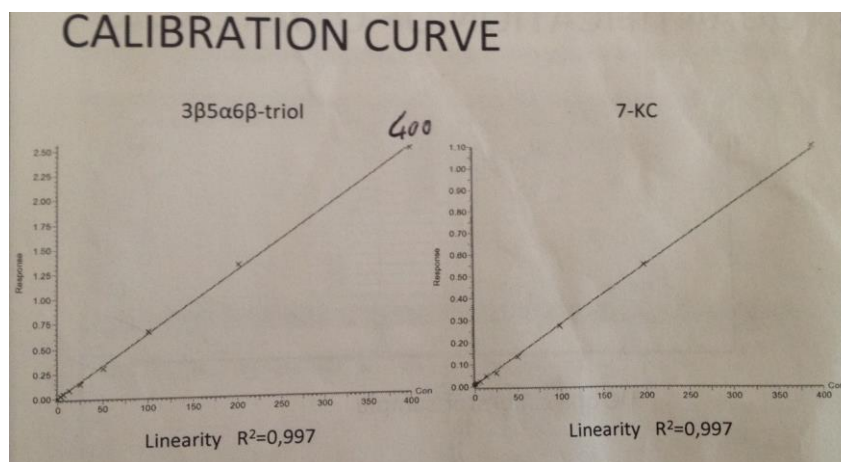
Statistical analyses were performed with the IBM SPSS for Windows Version 22.0. Numerical variables were summarized as mean±standard deviation and categorical variables as frequencies and percentages. Normality of the continuous variables was evaluated by Kolmogorov Smirnov test. Homogeneity of variances were tested by Levene test. Differences between the groups according to continuous variables were determined by independent samples t test or one way ANOVA. Pairwise comparisons were done by Tukey HSD or Games Howell test. Categorical variables were compared by Pearson chi square test. Relation between the continuous variables were determined by Pearson or Spearman correlation coefficient. Factors affecting 7-KC and were determined by multiple stepwise linear regression analysis. A p value less than 0,05 was considered as significant.



## 4. RESULTS

### 4.1. Calibration curves

All calibration curves were created by plotting the ratio of analyte area/IS area on the y-axis versus calibrator analyte concentration on the x-axis. Calibration points were obtained using calibrators at 8 levels (C1 to C8). A calibration curve was accepted if back calculated concentrations of the C8-C2 calibration standards were within  $\pm 15\%$  of the nominal value and the C1 was within  $\pm 20\%$ . At least 75 % standards should meet this criteria. The calibration curves, as shown in figure 4.1, for 7-KC and were linear over a range of injected calibrators ( $r^2 = 0.997$ ).

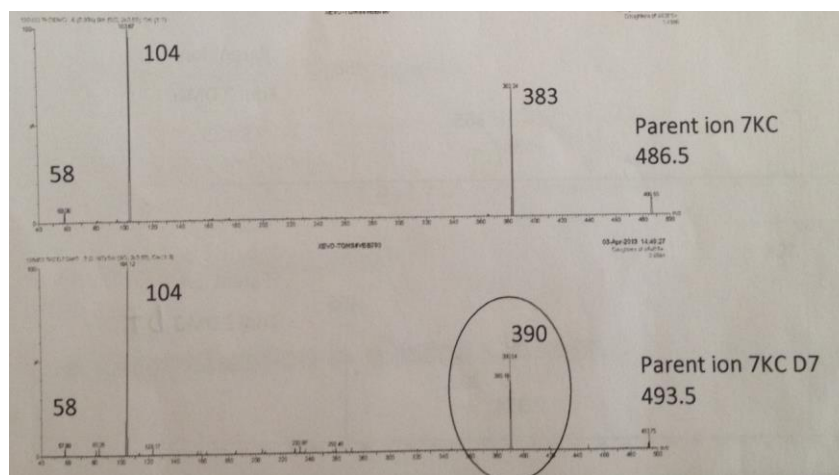


**Figure 4.1.** The calibration curves for 7-KC and cholestan-3 $\beta$ ,5 $\alpha$ ,6 $\beta$ -triol

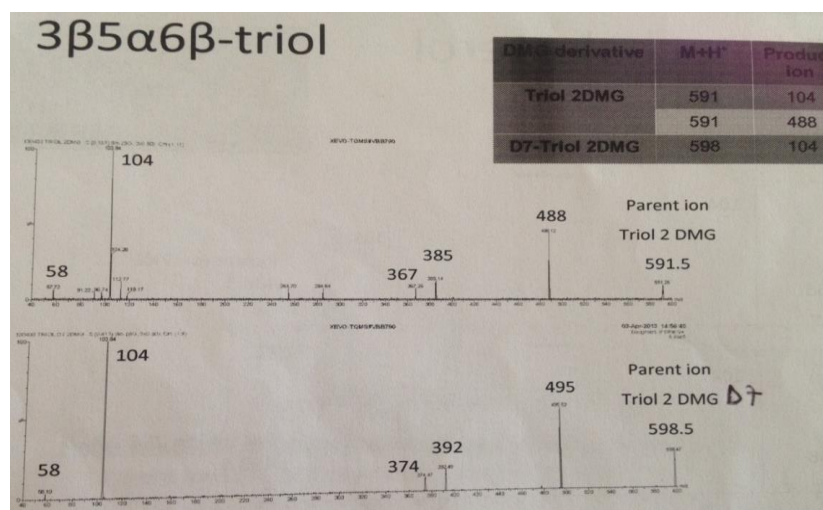
### 4.2. Mass spectra of plasma 7-KC and cholestan-3 $\beta$ ,5 $\alpha$ ,6 $\beta$ -triol

Figure 4.2 and 4.3 showed the mass spectra/mass fragmentograms of of 7-KC and cholestan-3 $\beta$ ,5 $\alpha$ ,6 $\beta$  triol. The parent ion for 7-KC was 486.5(m/z) and the parent ion for 7-KC D7 was 493.5 (m/z). The parent ion for and D7 were 591.5 (m/z) and 598.5 (m/z) respectively. The peaks for product ions were also observed as 383 (m/z) (quantifier) and 104 (m/z) (qualifier) for 7-KC.

The peaks for product ions were 104 (m/z) (quantifier) and 488 (m/z) (qualifier) for cholestan-3 $\beta$ ,5 $\alpha$ ,6 $\beta$ -triol. Analysis of all plasma samples showed peaks of 7-KC and at the same retention time with the standards.



**Figure 4.2.** Mass spectra/mass fragmentograms of 7-KC



**Figure 4.3.** Mass spectra/ mass fragmentograms of cholestan-3 $\beta$ ,5 $\alpha$ ,6 $\beta$  triol

### 4.3. Demographic data including oxysterols of the study groups and controls

Demographic data of the clinical and biochemical characteristics of subjects such as age, body mass index (BMI), glucose, HbA1c, total cholesterol, triglyceride as well as oxysterols from the studied groups and controls were compared and presented in Table 4.1.

**Table 4.1. Clinical and biochemical profiles of the studied groups**

	Healthy 1 <40	Healthy 2 ≥40	Type 1 DM	Type 2 DM	P Value
Female: Male	55:53	47:50	16:10	47:33	0.421
Age	24.2±9.0	56.3±10.8	27.46±7.2	56.2±10.1	<0.001¥
BMI (kg/m <sup>2</sup> )	20.9±1.4	21.6±1.9	25.75±5.19	32.85±4.64	<0.001*†¥
Total cholesterol (mg/dL)	156.1±20.1	163.8±26.2	205.65±17.59	228.94±39.64	<0.001*†¥
LDL (U/L)	89.2±11	100.8±14.5	127.2±27.45	139.50±38.09	<0.001*†
HDL (U/L)	43.8±5.6	49.1±7.0	46±12.24	46.83±12.65	0.202
VLDL (U/L)	26.4±5.6	30.3±7.6	40.65±10.78	50.30±29.03	<0.001*†
Triglyceride(mg/dL)	124.7±6.1	127.1±7.3	187.38±143.18	222.09±87.19	<0.001 †
Glucose (mg/dL)	76.8±5.8	83.9±7.4	204.54±74.99	176.98±49.13	<0.001*†
HbA1c	4.1±0.1	4.2±0.2	7.91±1.38	7.99±1.72	<0.001*†
ALT (U/L)	18.6±5.1	22.6±6.4	22.73±18.66	28.09±21.66	0.014
AST (U/L)	19±3.8	22.5±5.9	23.15±16.96	24.54±13.15	0.011
Number of risk factors	-	-	3,1±0,7	4,4±1,2	<0,001¥
7-Ketcholesterol (ng/ml)	18.33±3.76	19.72±2.47	42.75±11.54	84.80±43.71	<0.001*†¥
Cholestan-3β,5α,6β triol (ng/ml)	9.39±3.17	10.62±2.77	32.30±8.93	65.69±35.34	<0.001*†¥
7K/cholesterol	10.72±3.88	12.05±2.71	20.51±3.83	35.99±15.06	<0.001*†¥
3β/cholesterol	5.64±2.91	6.99±2.73	15.50±3.08	27.67±12.29	<0.001*†¥
7K/LDL	18.57±6.34	19.54±4.34	33.92±6.86	62.09±31.18	<0.001*†¥
3β/LDL	9.75±4.91	11.16±3.75	25.57±5.06	48.02±25.78	<0.001*†¥

-Data are expressed as mean ± SD; BMI: Body Mass Index

-\* Healthy <40 years - Type 1 different

-† Healthy ≥40 years - Type 2 different

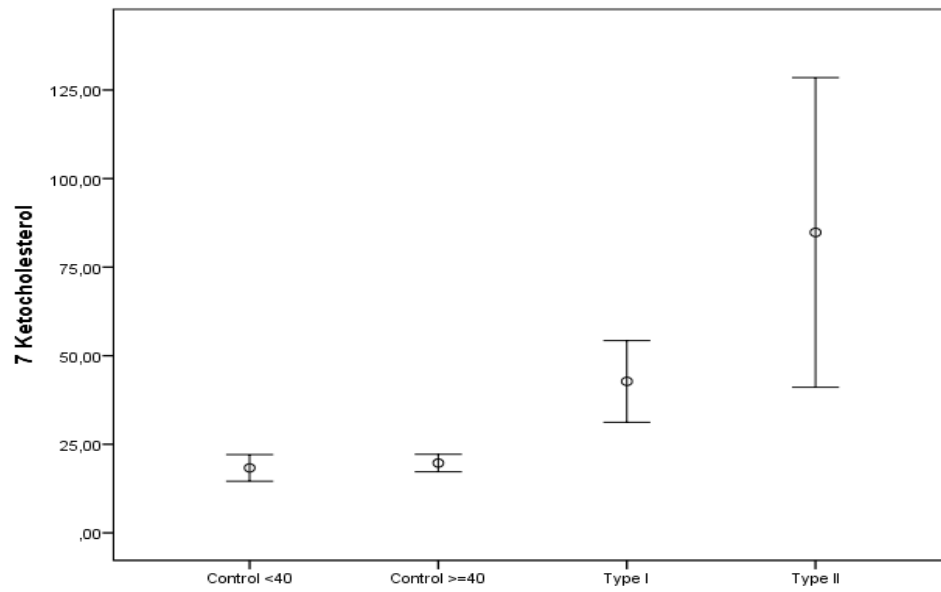
-¥ Type 1 - Type 2 different

Significant differences exist for BMI, total cholesterol, 7-KC and cholestan-3 $\beta$ ,5 $\alpha$ ,6 $\beta$  triol between all groups (type 1 DM-healthy, type 2 DM-healthy, type 1 DM-type 2 DM). The concentrations of glucose, HbA1c, LDL and VLDL were significantly increased in both types of DM compared to the control groups. There exists a significant difference for the number of risk factors between type 1 and type 2 DM.

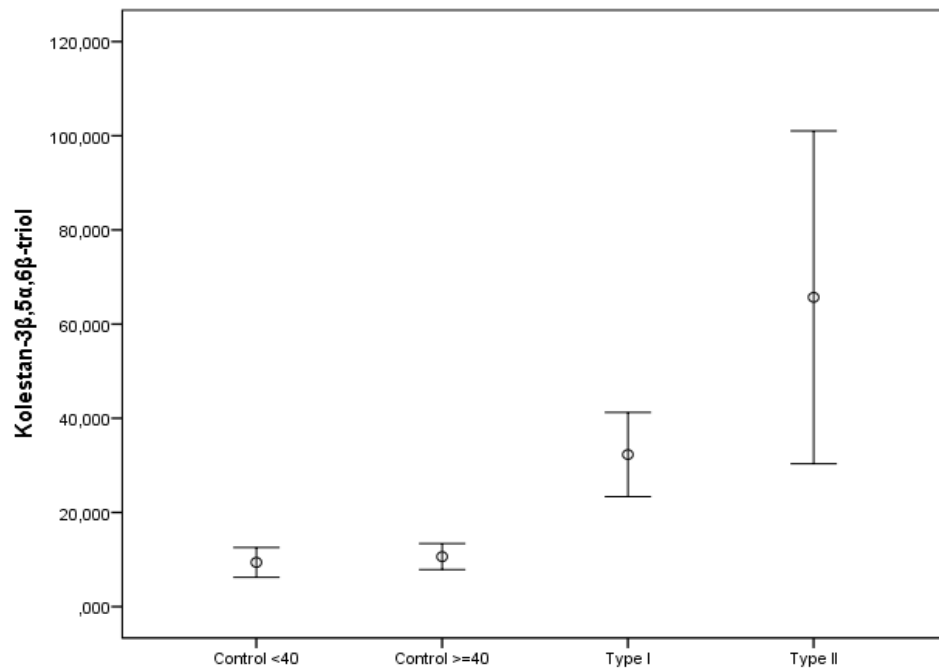
The patients with type 2 DM showed higher concentrations of total cholesterol, BMI, 7-KC and cholestan-3 $\beta$ ,5 $\alpha$ ,6 $\beta$ -triol compared to patients with type 1 DM. The patients with type 2 DM showed higher concentrations of triglycerides compared to healthy controls.

Plasma 7-KC levels in patients with type 1 DM (42.75 $\pm$ 11.54 ng/mL) and type 2 DM (84.80 $\pm$ 43.71 ng/mL) were significantly higher than those in control subjects (18.97 $\pm$ 3.83 ng/mL) ( $p$ <0.001). Type 1 and type 2 diabetic patients also demonstrated high levels of cholestan-3 $\beta$ ,5 $\alpha$ ,6 $\beta$ -triol (32.30 $\pm$ 8.93 ng/mL and 65.69 $\pm$ 35.34 ng/mL) compared to healthy controls (10.106 $\pm$ 3.94 ng/mL) ( $p$ <0.001). Significant high levels of both oxysterols were observed in type 2 DM compared to type 1 DM.

Since 7-KC and cholestan-3 $\beta$ ,5 $\alpha$ ,6 $\beta$ -triol are the non-enzymatic oxidation products of cholesterol, 7-KC and cholestan-3 $\beta$ ,5 $\alpha$ ,6 $\beta$ -triol concentrations were normalized to cholesterol and LDL as 7KC/Cholesterol, cholestan-3 $\beta$ ,5 $\alpha$ ,6 $\beta$  triol/Cholesterol, 7KC/LDL and cholestan-3 $\beta$ ,5 $\alpha$ ,6 $\beta$  triol/LDL. We obtained the same significant high patterns as plasma 7-KC and cholestan-3 $\beta$ ,5 $\alpha$ ,6 $\beta$ -triol alone. Plasma 7-KC and cholestan-3 $\beta$ ,5 $\alpha$ ,6 $\beta$ -triol levels were higher in type 1 and type 2 diabetic groups than in the control subjects, more clearly in type 2 DM, as shown in Figure 4.4 and Figure 4.5.



**Figure 4.4.** Plasma 7-KC levels in type 1, type 2 diabetic patients and controls



**Figure 4.5.** Plasma levels in type 1, type 2 diabetic patients and controls

#### 4.4. Correlations of oxysterol levels with biochemical parameters and coronary multiple risk factors in the study groups

To clarify the relationship between 7-KC, and coronary multiple risk factors, patients with type 1 and type 2 DM were divided into 6 groups with one or more risk factors (defined as multiple risk factor group). The risk factors was defined as LDL>130, BMI>30, hypertension (systolic blood pressure >130 mmHg, diastolic blood pressure > 85 mmHg), obesity (male: waist  $\geq$ 102 cm; female: waist  $\geq$ 88 cm), smoking, TG>150, HDL< 35 in male, <45 in female based on the criteria of the National Cholesterol Education Program (NCEP) as shown in table 4.2. Healthy volunteers were defined as no diabetes and no coronary risk factors.

**Table 4.2.** Coronary disease risk factors based on the criteria of national cholesterol education program

Risk Factors	Definition
Hypertension	Systolic blood pressure $\geq$ 130 mmHg, diastolic blood pressure $\geq$ 85 mmHg
Hypertriglyceridemia	Triglyceride $\geq$ 1.50 (mg/dL)
LDL	LDL $\geq$ 130
HDL	HDL Male < 35, Female:<45 Kadın
Smoking	Yes
Obesity	Male:waist $\geq$ 102 cm; female: waist $\geq$ 88 cm

Strong positive correlations of plasma 7-KC and cholestan-3 $\beta$ ,5 $\alpha$ ,6 $\beta$ -triol levels with glucose, HbA1c, and number of coronary risk factors were observed in type 2 DM. Positive correlations of oxysterols with total cholesterol were also observed. There exist correlations between oxysterols and triglyceride, LDL, VLDL (Table 4.3). No correlation was observed between oxysterols and HDL, ALT, AST levels and BM

**Table 4.3.** Correlations between oxysterols and biochemical parameters as well as BMI, waist circumference and number of risk factors in type 2 diabetic patients

	7-Ketokolesterol		Cholestan-3 $\beta$ ,5 $\alpha$ ,6 $\beta$ -triol	
	Correlation coefficient	P Value	Correlation coefficient	P Value
Age	-0.038	0.735	-0.034	0.764
BMI (kg/m <sup>2</sup> )	0.131	0.246	0.036	0.751
Waist cm	0.068	0.549	-0.048	0.673
Abdomen cm	0.270	0.015	0.201	0.074
LDL 130 mg/dL	0.445	<0.001	0.425	<0.001
HDL 40-60 mg/dL	-0.088	0.438	-0.088	0.435
Total Cholesterol 200 mg/dL	0.680	<0.001	0.725	<0.001
VLDL 40 mg/dL	0.438	<0.001	0.419	<0.001
TG 150	0.490	<0.001	0.414	<0.001
Glucose 70-100	0.999	<0.001	0.878	<0.001
HbA1c 4-6.5	0.998	<0.001	0.877	<0.001
ALT 35 U/L	0.039	0.734	-0.008	0.943
AST 35 U/L	0.061	0.592	0.037	0.745
Number of Risk Factors	0.968	<0.001	0.867	<0.001

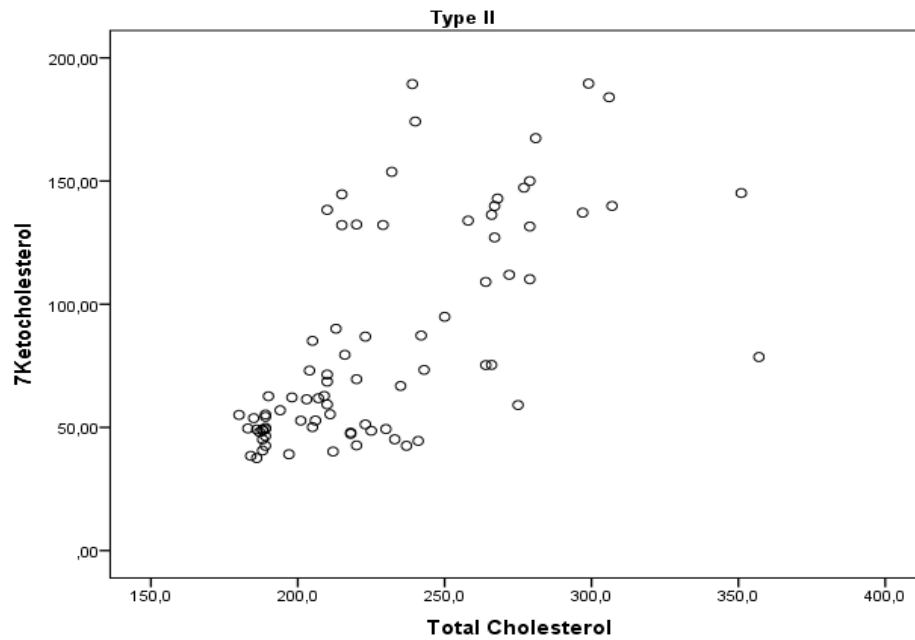
In type 1 diabetic patients we found strong positive correlations between oxysterols and glucose, HbA1c, serum total cholesterol, number of coronary risk factors. Positive correlations also exist between plasma between oxysterols and triglyceride, LDL, VLDL. Correlation with BMI was also found. (Table 4.4). Negative correlations, but not significant, were found between oxysterols and HDL, ALT, AST. (Table 4.4).

**Table 4.4.** Correlations between oxysterols and biochemical parameters as well as BMI, waist circumference and number of risk factors in type 1 diabetic patients

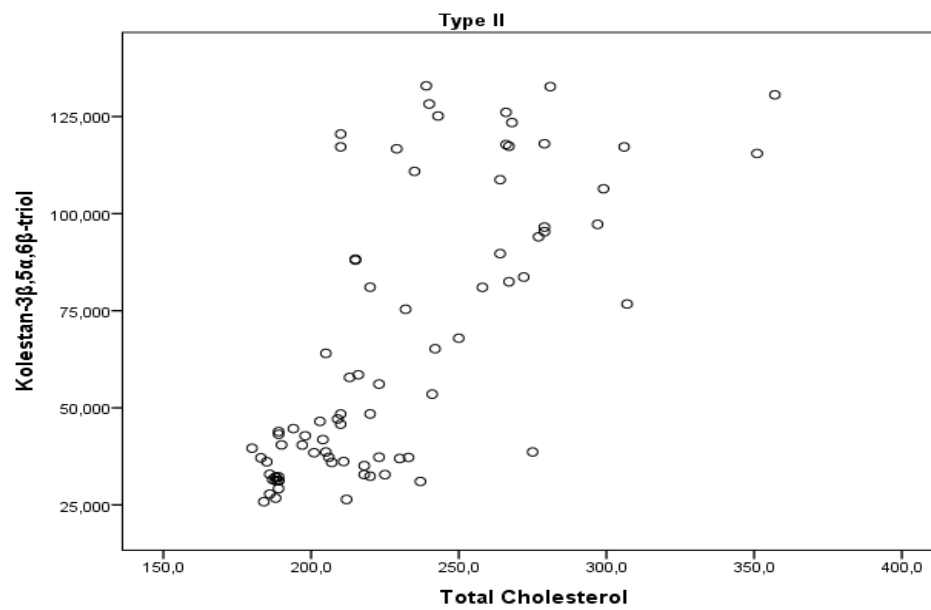
	7-Ketocholesterol		Cholestan-3 $\beta$ ,5 $\alpha$ ,6 $\beta$ -triol	
	Correlation coefficient	P Value	Correlation coefficient	P Value
Yaş	0.166	0.417	0.362	0.069
BMI (kg/m <sup>2</sup> )	0.468	0.016	0.411	0.037
Waist cm	0.253	0.213	0.155	0.449
Abdomen cm	0.341	0.088	0.238	0.242
LDL 130 mg/dL	0.686	<0.001	0.659	<0.001
HDL 40-60 mg/dL	-0.025	0.902	-0.134	0.515
Total Cholesterol 200 mg/dL	0.901	<0.001	0.900	<0.001
VLDL 40 mg/dL	0.685	<0.001	0.627	0.001
TG 150	0.638	<0.001	0.617	0.001
Glucose 70-100	1.000	-	0.887	<0.001
HbA1c 4-6.5	0.998	<0.001	0.896	<0.001
ALT 35 U/L	-0.015	0.940	-0.135	0.512
AST 35 U/L	-0.187	0.360	-0.281	0.164
Number of Risk Factors	0.748	<0.001	0.874	<0.001

Figure 4.6. shows that as cholesterol increases, 7-KC also increases in type 2 diabetic patients. The same as 7-KC, with increase of total cholesterol, cholestan-3 $\beta$ ,5 $\alpha$ ,6 $\beta$ -triol increases too (Figure 4.7). An interesting finding that we have found strong positive correlations between these oxysterols and glucose and HbA1c (Figures 4.8 and 4.9). We have also found high positive correlations between number of risk factors and 7-KC and cholestan-3 $\beta$ ,5 $\alpha$ ,6 $\beta$ -triol.

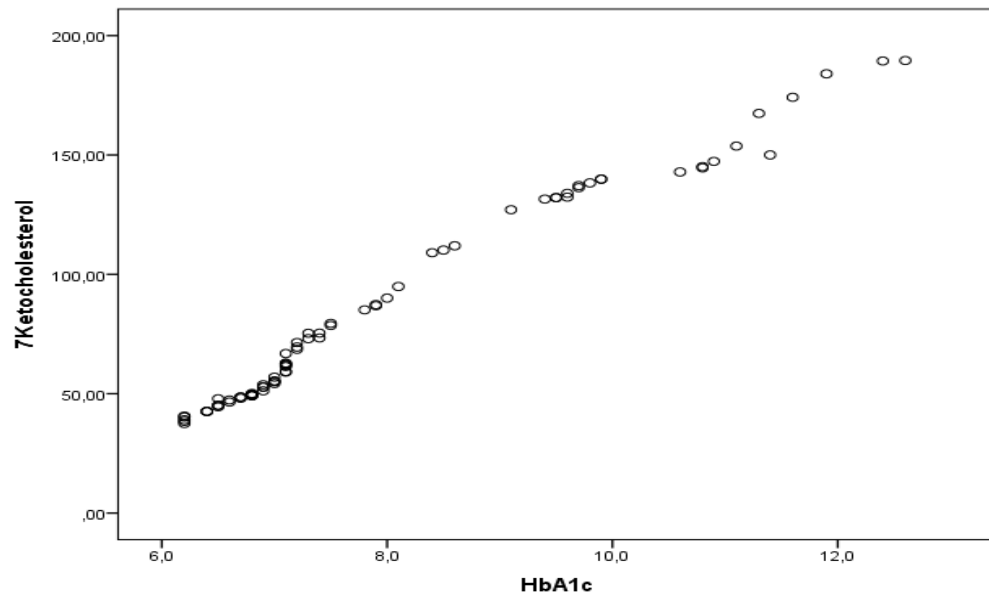




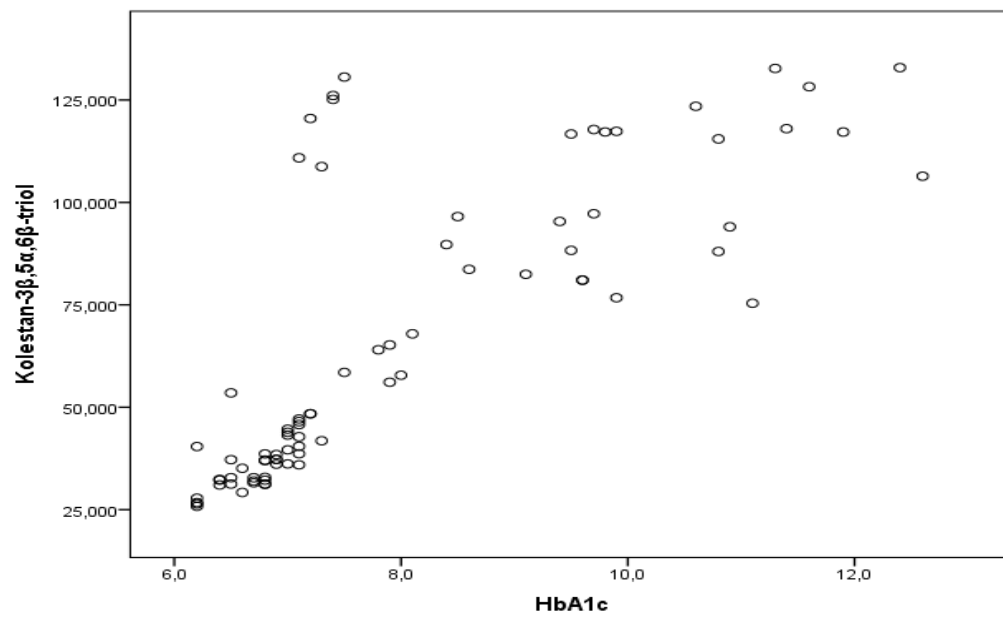
**Figure 4.6.** Positive correlation between 7-KC and total cholesterol



**Figure 4.7.** Positive correlation between cholesterol-3 $\beta$ ,5 $\alpha$ ,6 $\beta$ -triol and total cholesterol

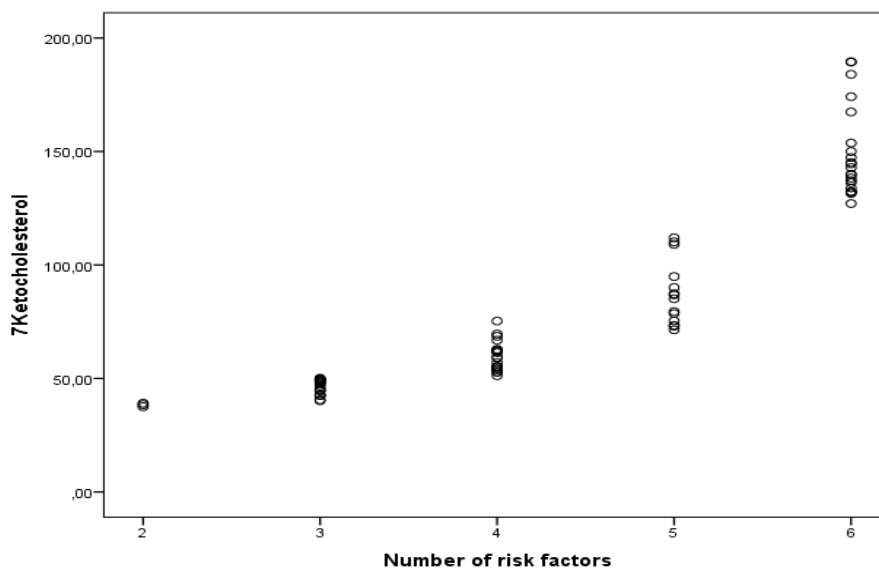


**Figure 4.8.** Positive correlation between 7-KC and HbA1c

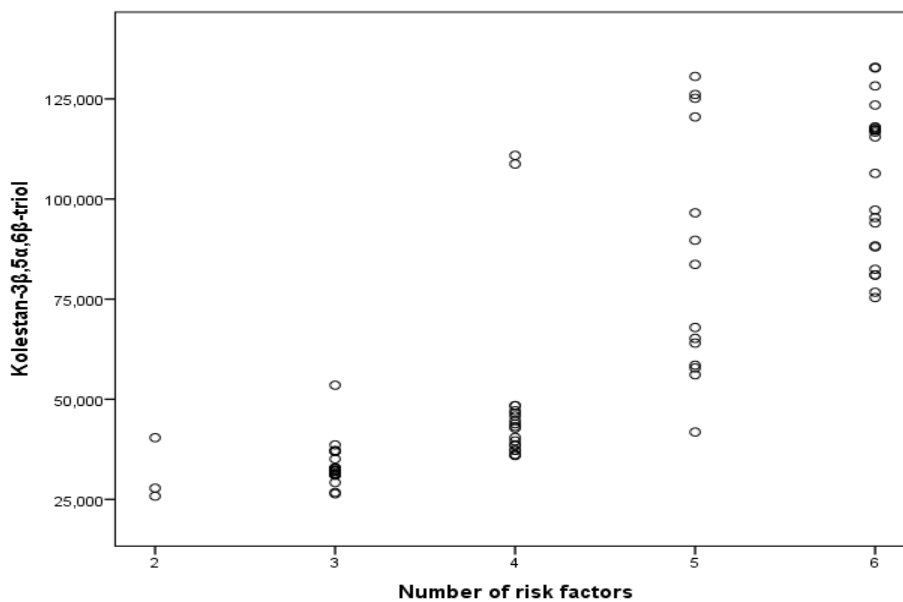


**Figure 4.9.** Positive correlation between cholestan-3β,5α,6β-triol and HbA1c

Figures 4. 10 and 4.11 show the positive correlations of oxysterols with number of risk factors. Diabetic patients who are carrying all the risk factors demonstrated higher levels of oxysterols compared to patients who have less risk factors.



**Figure 4.10.** Positive correlation between 7-KC and number of risk factors



**Figure 4.11.** Positive correlation between cholestan-3β,5α,6β-triol and number of risk factors

#### 4.5. Correlations of oxysterol levels with demographic data, microvascular complications and usage of drugs in the study groups

Microvascular complications were defined as nephropathy, retinopathy, and neuropathy in diabetic patients. We found correlations between plasma oxysterol levels and microvascular complications as well as smoking in type 1 diabetic patients. (Table 4.5).

**Table 4.5.** Evaluation of the correlation between 7-KC, cholestan-3 $\beta$ ,5 $\alpha$ ,6 $\beta$ -triol and demographic data, microvascular complications and usage of drugs of type 1 diabetic patients

		7-Ketocholesterol		Cholestan-3 $\beta$ ,5 $\alpha$ ,6 $\beta$ -triol	
		Mean $\pm$ SD	P value	Mean $\pm$ SD	P value
Presence of microvascular complication	No	36.7 $\pm$ 6.4	<0.001	27.5 $\pm$ 5.2	<0.001
	Yes	56.3 $\pm$ 8.6		43.2 $\pm$ 4.8	
Gender	F	40.0 $\pm$ 9.9	0.352	29.7 $\pm$ 8.0	0.250
	M	44.5 $\pm$ 12.5		33.9 $\pm$ 9.3	
Smoking	No	34.3 $\pm$ 4.5	<0.001	25.3 $\pm$ 3.0	<0.001
	Yes	52.6 $\pm$ 9.0		40.5 $\pm$ 5.9	
Family story	No	42.0 $\pm$ 9.2	0.698	31.7 $\pm$ 7.8	0.682
	Yes	44.2 $\pm$ 15.6		33.4 $\pm$ 11.2	
Hypertension	No	36.5 $\pm$ 17.9	0.858	30.8 $\pm$ 14.1	0.173
	Yes	35.8 $\pm$ 14.1		26.6 $\pm$ 11.5	
Use of statin	No	35.9 $\pm$ 13.5	0.936	28.6 $\pm$ 11.8	0.384
	Yes	36.2 $\pm$ 17.7		26.1 $\pm$ 13.2	
Use of insulin	No	34.2 $\pm$ 13.9	0.389	25.8 $\pm$ 11.6	0.249
	Yes	37.2 $\pm$ 15.8		29.0 $\pm$ 12.7	
Antihypertensive drug use	No	34.6 $\pm$ 14.5	0.386	28.0 $\pm$ 12.0	0.800
	Yes	37.5 $\pm$ 15.7		27.3 $\pm$ 12.8	
Aspirin use	No	35.7 $\pm$ 15.8	0.706	27.8 $\pm$ 12.9	0.832
	Yes	37.2 $\pm$ 12.4		27.1 $\pm$ 10.1	
Oral hypoglycemic Drug	No	38.2 $\pm$ 16.0	0.228	29.4 $\pm$ 11.7	0.246
	Yes	34.1 $\pm$ 14.1		26.2 $\pm$ 12.7	
Antihypertensive + Oral hypoglycemic	No	37.2 $\pm$ 15.5	0.264	29.0 $\pm$ 12.1	0.145
	Yes	33.1 $\pm$ 13.9		24.6 $\pm$ 12.4	

**Table 4.6.** Evaluation of the correlation between 7-KC, cholestan-3 $\beta$ ,5 $\alpha$ ,6 $\beta$ -triol and demographic data, microvascular complications and usage of drugs of type 2 diabetic patients

		7-Ketocholesterol		Cholestan-3 $\beta$ ,5 $\alpha$ ,6 $\beta$ -triol	
		Mean $\pm$ SD	P value	Mean $\pm$ SD	P value
Presence of microvascular complication	No		-	-	-
	Yes	84.4 $\pm$ 44.6		65.7 $\pm$ 35.3	
Gender	F	84.4 $\pm$ 44.6	0.931	61.9 $\pm$ 34.6	0.254
	M	85.3 $\pm$ 43.1		71.1 $\pm$ 36.1	
Smoking	No	56.1 $\pm$ 18.1	<0.001	42.2 $\pm$ 20.0	<0.001
	Yes	119.9 $\pm$ 40.1		94.4 $\pm$ 28.1	
Family story	No	83.8 $\pm$ 43.3	0.714	63.9 $\pm$ 35.2	0.420
	Yes	88.0 $\pm$ 45.9		71.4 $\pm$ 36.1	
Hypertension	No	74.7 $\pm$ 39.5	0.270	64.3 $\pm$ 34.7	0.851
	Yes	87.7 $\pm$ 44.7		66.1 $\pm$ 35.8	
Use of statin	No	113.0 $\pm$ 39.3	<0.001	89.2 $\pm$ 30.3	<0.001
	Yes	48.5 $\pm$ 5.8		35.4 $\pm$ 6.0	
Use of insulin	No	79.0 $\pm$ 40.5	0.323	59.8 $\pm$ 33.3	0.216
	Yes	88.9 $\pm$ 45.8		69.8 $\pm$ 36.5	
Antihypertensive drug use	No	85.5 $\pm$ 50.2	0.932	72.3 $\pm$ 37.9	0.325
	Yes	84.5 $\pm$ 41.6		63.4 $\pm$ 34.4	
Aspirin use	No	82.9 $\pm$ 44.1	0.456	65.0 $\pm$ 35.4	0.736
	Yes	91.9 $\pm$ 42.6		68.3 $\pm$ 36.0	
Oral hypoglycemic Drug	No	113.0 $\pm$ 39.3	<0.001	89.2 $\pm$ 30.3	<0.001
	Yes	48.5 $\pm$ 5.8		35.4 $\pm$ 6.0	
Antihypertensive + Oral hypoglycemic	No	102.3 $\pm$ 43.2	<0.001	80.8 $\pm$ 33.7	<0.001
	Yes	48.4 $\pm$ 6.2		34.3 $\pm$ 5.6	

All type 2 diabetic patients were having at least one microvascular complication in our study. Type 2 diabetic patients who were not using statins, antihypertension and/or oral hypoglycemic drugs showed increased oxysterol levels. (Table 4.6). cholestan-3 $\beta$ ,5 $\alpha$ ,6 $\beta$ -triol and 7-KC levels in type 2 diabetic patients. We have also found a high positive correlation between hypertension and statin users and 7-KC plasma levels in type 1 diabetic patients (Table 4.5). Smoking type 2 diabetic patients also showed higher levels of oxysterols (Table 4.6).

**Table 4.7.** Factors affecting 7-KC and cholestan-3 $\beta$ ,5 $\alpha$ ,6 $\beta$ -triol in type 2 DM group (Multiple stepwise regression analysis)

	<b>Factor</b>	<b>Regression coefficient (95% CI)</b>	<b>P Value</b>	<b>R<sup>2</sup></b>
7-KC	HbA1c	21.13 (19.81 – 22.46)	<0.001	0.988
	Statin Use	-7.37 (-11.27 – -3.46)	<0.001	
	Number of Risk Factors	4.00 (1.60 – 6.39)	0.001	
Cholestan-3 $\beta$ ,5 $\alpha$ ,6 $\beta$ triol	Number of Risk Factors	12.34 (7.42 – 17.25)	<0.001	0.773
	Total cholesterol	0.26 (0.14 – 0.39)	<0.001	
	Smoking	19.42 (8.43 – 30.40)	0.001	

Factors that are taken into stepwise regression analysis were ; abdomen, LDL, total cholesterol, triglyceride, glucose, HbA1c, number of risk factors, smoking and use of statin (Table 4.7). According to this table 1 unit increase in HbA1c causes an average increase of 21.13 units in 7-KC. In statin users, 7-KC average is lower by 7.37 units. When the number of risk factors increases by one unit, 7-KC increases by an average of 4 units. The use of statin, HbA1c, and the number of risk factors have accounted for 98.8% of the changes in 7-KC. As we can get from the data 1 unit increase in total cholesterol results in an average increase of 0.26 units in Cholestan-3 $\beta$ 5 $\alpha$ ,6 $\beta$ -triol. In smokers, the average of cholestan-3 $\beta$  is 19.42 more. When the number of risk factors increased by 1 unit, average of cholestan-3 $\beta$  increased by 12.34 units. Total cholesterol, smoking and risk factors accounted for 77.3% of the change in cholestan-3 $\beta$ 5 $\alpha$ ,6 $\beta$  triol.

## 5. DISCUSSION

Oxysterols, which are a large and diverse group of compounds, promote cell death, inflammation, immuno-suppression, cell proliferation, cytokine production, and platelet activation as well as considered as bioactive lipids recently (101, 104, 198). In the last decades, numerous endogenous mediators have been investigated to better understanding of DM and other metabolic syndromes. Among these, bioactive lipids such as bile acids, endocannabinoids, ceramides, sterol intermediates in cholesterol synthesis and their metabolites and finally oxysterols are clearly of interest (132, 199). Oxysterols are suggested as valuable markers for lipid peroxidation and DM has been proposed to be a state of increased free radical activity, high oxidant stress causing lipid peroxidation (200-202). In the elderly, increased lipid peroxidation contribute to increased oxysterol formation which favors the development of cardiovascular diseases and could trigger type 2 diabetes mellitus (202). In this study, we evaluated oxysterol species (7-ketocholesterol and cholestan-3 $\beta$ ,5 $\alpha$ ,6 $\beta$ -triol) as sensitive oxidative stress biomarkers in type 1 and type 2 DM by LC-ESI-MS/MS method. Their correlations with demographic data, clinical and biochemical parameters of type 1 and type 2 diabetic patients were also investigated. It is also known that oxysterols have cytotoxic and proinflammatory effects, therefore they could be related to complications of DM (200). The relationships between oxysterols and microvascular complications as well as usage of drugs were also searched. Besides these, we used a highly sensitive and reliable LC-ESI-MS/MS method to evaluate and measure plasma oxysterols levels.

Plasma 7-KC and cholestan-3 $\beta$ ,5 $\alpha$ ,6 $\beta$ -triol levels in type 1 and more clearly in type 2 diabetic patients were significantly higher than those in healthy subjects. To date, very few studies indicate that oxysterols contribute to the development of DM (105, 203). Endo et al. observed higher levels of 7-KC in type 2 DM compared to non-diabetic patients that was parallel with our study (204). They had a similar number of type 2 DM patients and healthy controls as our study, and their findings strongly supported our results.

The difference and may be an advantage of our work is that we included type 1 DM patients and investigate one more oxysterol type, cholestan-3 $\beta$ ,5 $\alpha$ ,6 $\beta$  triol. Guan et al. also reported higher levels of 7-KC by GC-MS in type 2 DM (205). More than 4-fold increase of 7-KC with HPLC were determined in diabetic rat tissues after injection of streptozotocin. The authors mentioned much greater increase for oxysterols compared to malondialdehyde, thiobarbituric acid reacting substances (TBARS) which have been widely used as oxidative stress biomarkers in DM (206). Abo et al. also reported significantly higher levels of plasma and erythrocyte 7-KC in diabetic patients (207). We also found more increased levels of oxysterols according to those reports in DM patients by using GC-MS which also indicated the sensitivity of LC-MS/MS compared to other chromatographic methods. From these findings together with our results, we conclude that 7-KC and cholestan-3 $\beta$ ,5 $\alpha$ ,6 $\beta$ -triol may be used as potential markers of oxidant stress in DM especially in type 2.

We found more increase in 7-KC levels compared to cholestan-3 $\beta$ ,5 $\alpha$ ,6 $\beta$ -triol in both types of DM. Among oxysterols 7-KC is produced non-enzymatically via a free radical mediated mechanism (104). 7-KC is also formed from 7 $\alpha$ -hydroxycholesterol by a NADP-dependent dehydrogenase in the liver microsome. One reason could be that both non-enzymatic and enzymatic production of 7-KC contribute to high levels of 7-KC in DM patients. Cholestane-3 $\beta$ ,5 $\alpha$ ,6 $\beta$ -triol is formed from 5,6-epoxycholesterol by the enzyme cholesterol epoxide hydrolase (106). The involvement of a disruption of redox homeostasis in diabetic patients and rat heart is supported by increased levels of 7 $\alpha$ -hydroxycholesterol and 7-KC which describes our findings that 7-KC was observed higher than cholestan-3 $\beta$ ,5 $\alpha$ ,6 $\beta$ -triol (208).

It is tempting to speculate that some oxysterols, especially those resulting from lipid peroxidation, may play a role in the development of this disease (105). Proflin-1, which is increased in the diabetic endothelium, is up-regulated by 7-KC via oxysterol binding protein 1 (209). Additionally, in the insulinoma cell line MIN6, which is derived from a transgenic mouse expressing the large T-antigen of SV40 in pancreatic beta cells, different effects of 7-KC have been observed including a decrease of insulin secretion into the culture medium (210). Thus, in addition to being biomarkers of oxidative stress,



oxysterols may have a role in the pathophysiology of DM with their cytotoxic and proinflammatory effects (139). It has been suggested that the imbalance of oxidative stress leads to impaired glucose uptake (211, 212). Antioxidant depletion and reactive oxygen species could impair the insulin-mediated PI3-kinase activation, which results in impaired glucose transporter 4 translocation and defective insulin-mediated glucose uptake (213). Oxidative stress leads to the activation of multiple cascades of serine kinases and protein tyrosine phosphatases, which are involved in the insulin signaling pathway and is linked to insulin resistance (212, 213). Oxidative stress is reported to enhance oxidative products such as malondialdehyde and glyoxal in the body and these products cause diabetic problems (214). With those findings, we could speculate that 7-KC may be used as an early systemic marker of oxidative stress in insulin resistance, which should be elucidated in future studies.

Positive correlations of plasma 7-KC and cholestan-3 $\beta$ ,5 $\alpha$ ,6 $\beta$ -triol levels with glucose, HbA1c, number of coronary risk factors triglyceride, LDL, VLDL, were found in both types of DM. We know that oxysterols resulting from spontaneous or enzymatic oxidation of cholesterol. The increased plasma levels of cholesterol can be regarded as an oxidation substrate to oxidative stress, especially by endothelial cells and activated monocytes (215). We also determined that as cholesterol increases, oxysterols increases too. Our data are also consistent with data by Murakami et al., who showed a high percentage of the total cholesterol predominantly oxidized at the position 7 (7 $\alpha$ -hydroxycholesterol, 7 $\beta$ -hydroxycholesterol and 7-ketocholesterol) in the blood plasma of type 2 diabetic patients (203). There are also reports speculating that plasma oxysterol levels might represent a useful marker of oxidative stress in patients with hyperlipidemia (203). In our study, 7-KC and cholestan-3 $\beta$ ,5 $\alpha$ ,6 $\beta$ -triol was significantly higher in diabetic patients when serum LDL was high. It is likely that oxidative stress may enhance the production of oxidized LDL, and oxidation of cholesterol in LDL may be promoted, consequently increasing 7-KC level (216, 217). The same hypothesis is notable for the positive correlation of VLDL with oxysterols in our study. Tremblay-Franco et al. measured variations of oxysterol levels in the serum of healthy, obese, and patients with metabolic syndrome. They found a significant increase in 7 $\beta$ -

hydroxycholesterol and 7-KC levels (218). In a cross-sectional study, the results of female adolescents were divided based on their insulin resistance or their obesity status, absolute plasma levels of 7 $\alpha$ -hydroxycholesterol, 7 $\beta$ -hydroxycholesterol, and 7-KC were increased in obese, compared with normal weight adolescents (219). Those findings supported and explained the positive correlation of oxysterols with triglyceride and waist circumference in our study. Besides, we showed that patients with type 2 DM presented higher levels of 7-KC and cholestan-3 $\beta$ ,5 $\alpha$ ,6 $\beta$ -triol than the type 1 DM and healthy controls. Our study together with 2 studies clearly showed that in the context of metabolic syndrome, oxysterol levels are mostly altered relative to control subjects. Indeed, as mentioned before, relation of insulin resistance and oxysterol is another important feature.

Since oxysterols are cholesterol oxidation products, we normalized both of the oxysterol types to cholesterol and LDL. We obtained significant high levels of glucose and HbA1c in study groups whom their plasma 7-KC and cholestan-3 $\beta$ ,5 $\alpha$ ,6 $\beta$ -triol were high. These data suggest that oxysterols may control glucose homeostasis through different pathways and some of the proposed pathophysiological mechanisms are described above. Moreover, we can suggest that an imbalance of oxidative stress leads to impaired glucose uptake.

Although researchers showed that oxysterols inhibit endothelial nitric oxide synthase and nitric oxide production, another report suggested that the activation of hyperglycemia-dependent nuclear factor kappa B (NF- $\kappa$ B) observed in patients with DM could increase nitric oxide production via inducible nitric oxide synthase (220, 221). Guan et al., reported the decrease of 7-KC by administration of fluvastatin, which was parallel with our results (205). Further studies are needed to clear the underlying mechanisms in DM complications in terms of oxysterols.

Laboratory analysis of oxysterols in biological materials is not easy because of the presence of diverse compounds having structures closely related to cholesterol and because of great differences between their concentrations and the concentration of cholesterol (203). The present study describes a LC-ESI-MS/MS approach, for

determining oxysterols, which may overcome some GC-MS limitations reported for analyzing oxysterol species. In a study by Ferderbar et al., they did not observe elevated levels of 7-KC in the plasma of type 1 and type 2 diabetic subjects (221). These discordances may be related to the different analytical methodologies and protocols used in the different studies. The difference between the present study and previous studies on measuring oxysterol species is sensitivity and excellent selectivity of our LC-ESI-MS/MS method. It is worth mentioning that our LC-MS/MS method for analyzing cholesterol oxidation products is more sensitive and reliable than other methods, working on this subject.

In this study, we found a positive correlation between 7-KC, cholestan-3 $\beta$ ,5 $\alpha$ ,6 $\beta$ -triol and glycated hemoglobin, suggests that their generation is related to the intensity of glycation and/or glycooxidation. Our regression analysis has shown that a one unit increase in HbA1c causes an average increase of 21.13 units at 7-KC. According to regression analysis, any changes in HbA1c, account for 98.8% of the change in total 7-KC. Actually, some in vitro studies have shown that incubation of erythrocytes with elevated levels of glucose results in increased membrane lipid peroxidation (222). In hyperglycemia induced oxidative stress, it can be expected that the poorer the glycemic control, the higher the formation of oxysterols is. A hyperglycemia-dependent Nuclear factor kappa B (NF- $\kappa$ B) activation was observed in patients with diabetes mellitus (213). Ferderbar, S., et al also showed positive correlation between some oxysterols and glycated hemoglobin (221). We have also found that there is a positive correlation between glucose and 7-KC, cholestan-3 $\beta$ ,5 $\alpha$ ,6 $\beta$ -triol. Collectively, these data suggest that oxysterols may control glucose homeostasis through different pathways. It has been suggested that the imbalance of oxidative stress leads to impaired glucose uptake (212). Antioxidant depletion and reactive oxygen species could impair the insulin-mediated PI3 kinase activation, which results in impaired glucose transporter 4 translocation and defective insulin-mediated glucose uptake (213). Therefore, it is speculated that 7-KC may be an early systemic marker of oxidative stress in insulin resistance, which must be elucidated in future studies. In our study some of patients with type 2 diabetes were being treated with oral hypoglycemic drugs, aspirin, insulin and metmorphin and some

of them were receiving statins or antihypertensive (ACE inhibitors) drugs. These drugs have other beneficial effects that could be involved in the decrease of the oxidative stress in diabetes. It is interesting to point out that statins and oral hypoglycaemic+antihypertensive drugs in type 2 diabetic patients reduced the levels of 7-KC and cholestan-3 $\beta$ ,5 $\alpha$ ,6 $\beta$ -triol. In statin users, the average of 7-KC was 7.37 units lower. Guan et al also reported the decrease of 7-KC by administration of fluvastatin (205).

No significant correlation was observed between insulin aspirin and metmorphin uses in type 2 diabetic patients and oxysterols. Significant correlation was not observed between insulin use and 7-KC and cholestan-3 $\beta$ ,5 $\alpha$ ,6 $\beta$ -triol. We also found that that 7-KC and cholestan-3 $\beta$ ,5 $\alpha$ ,6 $\beta$ -triol was increased in proportion to the number of coronary risk factors. 7-KC and cholestan-3 $\beta$ ,5 $\alpha$ ,6 $\beta$ -triol levels was significantly higher in the multiple risk factor group than non-multiple risk factors group that was parallel to Endo, Kei, et al studies (204). As for the mechanism of increase in 7-KC due to multiple risk factors, we speculated that oxidative stress might be involved. When the number of risk factors increases by one unit, 7-KC increases by an average of 4 units. Both type 2 DM and concomitant occurrence of coronary risk factors such as metabolic syndrome are typical diseases showing elevated oxidative stress (223, 224).

Oxidative stress is reported to increase oxidative products such as glyoxal and malondialdehyde in the body and these products cause diabetic complications (214). We found that 7-KC and cholestan-3 $\beta$ ,5 $\alpha$ ,6 $\beta$ -triol may be regulated by multiple risk factors and these results suggest a possible relationship between these oxysterols and coronary heart disease. When the number of risk factors increases by one unit, and 7-KC increases by an average of 12.34 and 4 units respectively. Since lipid peroxidation products seems to be closely related to the complications of diabetes, oxysterols such as 7-KC and cholestan-3 $\beta$ ,5 $\alpha$ ,6 $\beta$ -triol may represent helpful and valuable biomarkers in the clinical follow-up of diabetic patients for coronary heart disease.

We have found increased plasma concentration levels of 7-KC and cholestan-3 $\beta$ ,5 $\alpha$ ,6 $\beta$ -triol in both type 1 and type 2 diabetic patients who were smokers. In smoker diabetic patients, the average of was 19.42 units higher than non smoker patients. Mol, Marc JTM, et al. also found a positive correlation between smoking and increase in cholesterol oxidation products (225). This finding strengthens evidence of other findings in this area. These findings are relevant because development of type 2 diabetes is another possible consequence of cigarette smoking, besides the better-known increased risk for cardiovascular disease. In diabetes care, smoking cessation is of utmost importance to facilitate glycemic control and limit the development of diabetic complications (226).

As a final point, 7-KC and cholestan-3 $\beta$ ,5 $\alpha$ ,6 $\beta$ -triol may represent helpful and valuable biomarkers for oxidative stress, mainly in type 2 DM. Both type 2 DM and concomitant occurrence of metabolic syndrome signs showed elevated levels of oxysterols suggesting that an imbalance of oxidative stress leads to impaired glucose uptake. Oxidative stress is likely a causative factor in the development of insulin resistance. Plasma oxysterol levels might represent useful markers of oxidative stress in patients with hyperlipidemia and in context of metabolic syndrome.

They could be used as early markers in developing type 2 DM. The underlying mechanisms should be clarified with future works. Our study is the second report so far describing oxysterol production in patients with type 1 DM. Systemic increase in the levels of cholesterol oxidation products seems to be a reliable biomarker of cholesterol oxidation in tissues, which may be useful in routine clinical practice. According to clinical studies, in vitro experiments and animal models, there are some evidences that several oxysterols resulting either from cholesterol autoxidation or enzymatic oxidation of cholesterol are involved in DM.

## Highlights

- Significant elevated levels of 7-KC and cholestan-3 $\beta$ ,5 $\alpha$ ,6 $\beta$ -triol were observed in type 1 and more clearly in type 2 diabetic patients.
- Oxysterols can be used as sensitive biomarkers in the evaluation of oxidative stress in both types of DM, more clearly in type 2 DM.
- Positive correlations of plasma 7-KC and cholestan-3 $\beta$ ,5 $\alpha$ ,6 $\beta$ -triol levels with glucose, HbA1c, number of coronary risk factors, triglyceride, LDL, VLDL, were found in both types of DM.
- Positive correlation between 7-KC, and glycated hemoglobin suggests that their generation is related to the intensity of glycation and/or glycooxidation.
- 7-KC and cholestan-3 $\beta$ ,5 $\alpha$ ,6 $\beta$ -triol increased in proportion to the number of coronary risk factors. Oxysterols may represent helpful and valuable biomarkers in the clinical follow-up of diabetic patients for coronary heart disease.
- We have found increased plasma concentration levels of 7-KC and cholestan-3 $\beta$ ,5 $\alpha$ , 6 $\beta$ -triol in both type 1 and type 2 diabetic patients who were smokers.
- Statins and oral hypoglycemic+antihypertensive drugs in type 2 diabetic patients reduced the levels of 7-KC and cholestan-3 $\beta$ ,5 $\alpha$ ,6 $\beta$ -triol which suggest other beneficial effects of these drugs that could be involved in the decrease of the oxidative stress in diabetes.
- Plasma oxysterol levels might represent an useful marker of oxidative stress in patients with hyperlipidemia and in context of metabolic syndrome.
- Oxidative stress is likely a causative factor in the development of insulin resistance.
- Our study is the second report so far describing oxysterol production in patients with type 1 DM.
- LC-ESI-MS/MS method is a highly sensitive and specific, thus a reliable method for analyzing cholesterol oxidation products.

- Further investigations are required for the mechanisms of how oxysterols contribute to DM.
- Better knowledge of the biological activities of oxysterols of the interest permits the improvements in new therapeutic strategies.

## REFERENCES

1. Mellitus D. Diagnosis and classification of diabetes mellitus. *Diabetes care*. 2005;28:S37.
2. Assal J, Groop L. Definition, diagnosis and classification of diabetes mellitus and its complications. World Health Organization. 1999:1-65.
3. Poretsky L. *Principles of diabetes mellitus*: Springer; 2010.
4. Medvei VC. *The history of clinical endocrinology: a comprehensive account of endocrinology from earliest times to the present day*: CRC Press; 1993.
5. Hanley AJ, Karter AJ, Williams K, Festa A, D'Agostino RB, Wagenknecht LE, et al. Prediction of type 2 diabetes mellitus with alternative definitions of the metabolic syndrome the insulin resistance atherosclerosis study. *Circulation*. 2005;112(24):3713-21.
6. Dobson M, Fothergill J. *Experiments and Observations on the Urine in a Diabetes* 1776.
7. Medvei V. *Chronological tables. The History of Clinical Endocrinology: A Comprehensive Account of Endocrinology from Earliest Times to the Present Day* New York: Parthenon Publishing. 1993;495.
8. Bouchardat A. *De la glycosurie ou diabet sucre*, Vol. 2. Paris: Germer-Bailliere. 1875.
9. Lancereaux E. *Le diabete maigre: ses symptomes, son evolution, son prognostie et son traitement*. *Un Med Paris*. 1880;20:205-11.
10. Association AD. Diagnosis and classification of diabetes mellitus. *Diabetes care*. 2010;33(Supplement 1):S62-S9.
11. TA S. Diagnosis and classification of diabetes mellitus. *Diabetes care*. 2014;37:S81.
12. Gavin III JR, Alberti K, Davidson MB, DeFronzo RA. Report of the expert committee on the diagnosis and classification of diabetes mellitus. *Diabetes care*. 1997;20(7):1183.
13. Ahmad SI. *Diabetes: An Old Disease, a New Insight*: Springer Science & Business Media; 2013.
14. Fowler MJ. Microvascular and macrovascular complications of diabetes. *Clinical Diabetes*. 2011;29(3):116-22.
15. Joslin EP, Kahn CR. *Joslin's Diabetes Mellitus*: Edited by C. Ronald Kahn... [et Al.]: Lippincott Williams & Wilkins; 2005.
16. Association AD. Diagnosis and classification of diabetes mellitus. *Diabetes care*. 2008;31(Supplement 1):S55-S60.
17. Alberti KGMM, Zimmet Pf. Definition, diagnosis and classification of diabetes mellitus and its complications. Part 1: diagnosis and classification of diabetes mellitus. Provisional report of a WHO consultation. *Diabetic medicine*. 1998;15(7):539-53.



18. Seino Y, Nanjo K, Tajima N, Kadowaki T, Kashiwagi A, Araki E, et al. Report of the committee on the classification and diagnostic criteria of diabetes mellitus. *Journal of diabetes investigation*. 2010;1(5):212-28.
19. Association AD. 2. Classification and diagnosis of diabetes. *Diabetes care*. 2015;38(Supplement 1):S8-S16.
20. Pickup JC, Williams G. *Textbook of diabetes*. Vol. 2: Blackwell Science; 1997.
21. Tominaga M, Eguchi H, Manaka H, Igarashi K, Kato T, Sekikawa A. Impaired glucose tolerance is a risk factor for cardiovascular disease, but not impaired fasting glucose. The Funagata Diabetes Study. *Diabetes care*. 1999;22(6):920-4.
22. Gabir MM, Hanson RL, Dabelea D, Imperatore G, Roumain J, Bennett PH, et al. The 1997 American Diabetes Association and 1999 World Health Organization criteria for hyperglycemia in the diagnosis and prediction of diabetes. *Diabetes care*. 2000;23(8):1108-12.
23. de Vegt F, Dekker JM, Jager A, Hienkens E, Kostense PJ, Stehouwer CD, et al. Relation of impaired fasting and postload glucose with incident type 2 diabetes in a Dutch population: The Hoorn Study. *Jama*. 2001;285(16):2109-13.
24. Harris MI, Flegal KM, Cowie CC, Eberhardt MS, Goldstein DE, Little RR, et al. Prevalence of diabetes, impaired fasting glucose, and impaired glucose tolerance in US adults: the Third National Health and Nutrition Examination Survey, 1988–1994. *Diabetes care*. 1998;21(4):518-24.
25. DeFronzo RA, Ferrannini E. Insulin resistance: a multifaceted syndrome responsible for NIDDM, obesity, hypertension, dyslipidemia, and atherosclerotic cardiovascular disease. *Diabetes care*. 1991;14(3):173-94.
26. Association AD. Diagnosis and classification of diabetes mellitus. *Diabetes care*. 2005;28:S37.
27. Group NDD. Classification and diagnosis of diabetes mellitus and other categories of glucose intolerance. *Diabetes*. 1979;28(12):1039-57.
28. Pearson ER, Starkey BJ, Powell RJ, Gribble FM, Clark PM, Hattersley AT. Genetic cause of hyperglycaemia and response to treatment in diabetes. *The Lancet*. 2003;362(9392):1275-81.
29. Cooke DW, Plotnick L. Type 1 diabetes mellitus in pediatrics. *Pediatr Rev*. 2008;29(11):374-84.
30. Epstein FH, Atkinson MA, Maclaren NK. The pathogenesis of insulin-dependent diabetes mellitus. *New England Journal of Medicine*. 1994;331(21):1428-36.
31. Phillips JM, Parish NM, Raine T, Bland C, Sawyer Y, De La Peña H, et al. Type 1 diabetes development requires both CD4+ and CD8+ T cells and can be reversed by non-depleting antibodies targeting both T cell populations. *The review of diabetic studies: RDS*. 2009;6(2):97.
32. Roep BO. The role of T-cells in the pathogenesis of Type 1 diabetes: from cause to cure. *Diabetologia*. 2003;46(3):305-21.
33. Jun HS, Yoon JW. A new look at viruses in type 1 diabetes. *Diabetes/metabolism research and reviews*. 2003;19(1):8-31.

34. Fairweather D, Rose NR. Type 1 diabetes: virus infection or autoimmune disease? *Nature immunology*. 2002;3(4):338-40.
35. Kaufman D, Erlander M, Clare-Salzler M, Atkinson M, Maclaren N, Tobin A. Autoimmunity to two forms of glutamate decarboxylase in insulin-dependent diabetes mellitus. *Journal of Clinical Investigation*. 1992;89(1):283.
36. Lu J, Li Q, Xie H, Chen Z-J, Borovitskaya AE, Maclaren NK, et al. Identification of a second transmembrane protein tyrosine phosphatase, IA-2beta, as an autoantigen in insulin-dependent diabetes mellitus: precursor of the 37-kDa tryptic fragment. *Proceedings of the National Academy of Sciences*. 1996;93(6):2307-11.
37. Association AD. Diagnosis and classification of diabetes mellitus. *Diabetes care*. 2006;29(1):S43.
38. Abiru N, Kawasaki E, Eguch K. Current knowledge of Japanese type 1 diabetic syndrome. *Diabetes/metabolism research and reviews*. 2002;18(5):357-66.
39. Todd JA. From genome to aetiology in a multifactorial disease, type 1 diabetes. *Bioessays*. 1999;21(2):164-74.
40. Imagawa A, Hanafusa T, Miyagawa J-i, Matsuzawa Y. A novel subtype of type 1 diabetes mellitus characterized by a rapid onset and an absence of diabetes-related antibodies. *New England journal of medicine*. 2000;342(5):301-7.
41. Davies JL, Kawaguchi Y, Bennett ST, Copeman JB, Cordell HJ, Pritchard LE, et al. A genome-wide search for human type 1 diabetes susceptibility genes. *Nature*. 1994;371(6493):130-6.
42. Melit LE, Marginean O, Campean C, Marginean MO. Type I Diabetes Mellitus—Diagnosis Based on Complications. *Romanian Journal of Pediatrics*. 2015;64(2).
43. Bottazzo GF, Dean BM, McNally JM, MacKay EH, Swift PG, Gamble DR. In situ characterization of autoimmune phenomena and expression of HLA molecules in the pancreas in diabetic insulinitis. *New England Journal of Medicine*. 1985;313(6):353-60.
44. Van Belle TL, Coppieters KT, Von Herrath MG. Type 1 diabetes: etiology, immunology, and therapeutic strategies. *Physiological reviews*. 2011;91(1):79-118.
45. Holt RI, Cockram C, Flyvbjerg A, Goldstein BJ. *Textbook of diabetes*: John Wiley & Sons; 2011.
46. Awdeh Z, Yunis EJ, Audeh MJ, Fici D, Pugliese A, Larsen CE, et al. A genetic explanation for the rising incidence of type 1 diabetes, a polygenic disease. *Journal of autoimmunity*. 2006;27(3):174-81.
47. Karvonen M, Tuomilehto J, Libman I, LaPorte R. A review of the recent epidemiological data on the worldwide incidence of type 1 (insulin-dependent) diabetes mellitus. *Diabetologia*. 1993;36(10):883-92.
48. Rothman KJ, Greenland S. *Measures of disease frequency*: na; 1998.
49. Craig ME, Hattersley A, Donaghue KC. Definition, epidemiology and classification of diabetes in children and adolescents. *Pediatric diabetes*. 2009;10(s12):3-12.

50. Borchers AT, Uibo R, Gershwin M. The geoepidemiology of type 1 diabetes. *Autoimmunity reviews*. 2010;9(5):A355-A65.
51. Cardwell C, Carson D, Patterson C. Higher incidence of childhood-onset type 1 diabetes mellitus in remote areas: a UK regional small-area analysis. *Diabetologia*. 2006;49(9):2074-7.
52. Gale E. Spring harvest? Reflections on the rise of type 1 diabetes. *Diabetologia*. 2005;48(12):2445-50.
53. Hüseyin D, Nuri ÖM, Taner BR. Month: 6 Volume: 5 Issue 2 Viewed 1211 times Received. Month. 2013.
54. Yudkin JS. Insulin for the world's poorest countries. *The Lancet*. 2000;355(9207):919-21.
55. Shaw JE, Sicree R. Epidemiology of type 2 diabetes. *Type 2 Diabetes Mellitus: Springer*; 2008. p. 1-16.
56. Association AD. Diagnosis and classification of diabetes mellitus. *Diabetes Care*. 2014;37(Supplement 1):S81-S90.
57. Rudenski A, Hadden D, Atkinson A, Kennedy L, Matthews D, Merrett J, et al. Natural history of pancreatic islet B-cell function in type 2 diabetes mellitus studied over six years by homeostasis model assessment. *Diabetic medicine*. 1988;5(1):36-41.
58. Turner RC, Cull CA, Frighi V, Holman RR, Group UPDS. Glycemic control with diet, sulfonylurea, metformin, or insulin in patients with type 2 diabetes mellitus: progressive requirement for multiple therapies (UKPDS 49). *Jama*. 1999;281(21):2005-12.
59. Mokdad AH, Bowman BA, Ford ES, Vinicor F, Marks JS, Koplan JP. The continuing epidemics of obesity and diabetes in the United States. *Jama*. 2001;286(10):1195-200.
60. Knowler WC, Saad MF, Pettitt DJ, Nelson RG, Bennett PH. Determinants of diabetes mellitus in the Pima Indians. *Diabetes Care*. 1993;16(1):216-27.
61. Bonora E, Kiechl S, Willeit J, Oberhollenzer F, Egger G, Meigs JB, et al. Population-based incidence rates and risk factors for type 2 diabetes in White individuals The Bruneck Study. *Diabetes*. 2004;53(7):1782-9.
62. Mensink M, Corpeleijn E, Feskens EJ, Kruijshoop M, Saris WH, de Bruin TW, et al. Study on lifestyle-intervention and impaired glucose tolerance Maastricht (SLIM): design and screening results. *Diabetes research and clinical practice*. 2003;61(1):49-58.
63. Reinehr T. Clinical presentation of type 2 diabetes mellitus in children and adolescents. *International Journal of Obesity*. 2005;29:S105-S110.
64. Reinehr T, Roth C, Menke T, Andler W. Adiponectin before and after weight loss in obese children. *The Journal of Clinical Endocrinology & Metabolism*. 2004;89(8):3790-4.
66. Uk P. Intensive blood-glucose control with sulfonylureas or insulin compared with conventional treatment and risk of complications in patients with type II diabetes. *Lancet*. 1998;352:837-53.
67. D'Adamo E, Caprio S. Type 2 diabetes in youth: epidemiology and pathophysiology. *Diabetes care*. 2011;34(Supplement 2):S161-S5.

68. DeFronzo RA. From the triumvirate to the ominous octet: a new paradigm for the treatment of type 2 diabetes mellitus. *Diabetes*. 2009;58(4):773-95.
69. Pinhas-Hamiel O, Zeitler P. Acute and chronic complications of type 2 diabetes mellitus in children and adolescents. *The Lancet*. 2007;369(9575):1823-31.
70. Leahy JL. Pathogenesis of type 2 diabetes mellitus. *Archives of medical research*. 2005;36(3):197-209.
71. Zimmet P, Alberti K, Shaw J. Global and societal implications of the diabetes epidemic. *Nature*. 2001;414(6865):782-7.
72. Huizinga MM, Rothman RL. Addressing the diabetes pandemic: a comprehensive approach. *The Indian journal of medical research*. 2006;124(5):481.
73. Wild S, Roglic G, Green A, Sicree R, King H. Global prevalence of diabetes estimates for the year 2000 and projections for 2030. *Diabetes care*. 2004;27(5):1047-53.
74. Feinglos MN, Bethel MA. *Type 2 Diabetes Mellitus: An Evidence-Based Approach to Practical Management*: Springer Science & Business Media; 2008.
75. Fagot-Campagna A, Narayan KV, Imperatore G. Type 2 diabetes in children: exemplifies the growing problem of chronic diseases. *BMJ: British Medical Journal*. 2001;322(7283):377.
76. Rosenbloom AL, Silverstein JH, Amemiya S, Zeitler P, Klingensmith GJ. Type 2 diabetes in children and adolescents. *Pediatric Diabetes*. 2009;10(s12):17-32.
77. Dabelea D, Bell RA, D'Agostino Jr RB, Imperatore G, Johansen JM, Linder B, et al. Incidence of diabetes in youth in the United States. *Jama*. 2007;297(24):2716-24.
78. Sinha R, Fisch G, Teague B, Tamborlane WV, Banyas B, Allen K, et al. Prevalence of impaired glucose tolerance among children and adolescents with marked obesity. *New England Journal of Medicine*. 2002;346(11):802-10.
79. Meek CL, Lewis HB, Patient C, Murphy HR, Simmons D. Diagnosis of gestational diabetes mellitus: falling through the net. *Diabetologia*. 2015;58(9):2003-12.
80. Alfadhli EM. Gestational diabetes mellitus. *Saudi Medical Journal*. 2015;36(4):399.
81. Sugiyama T. Management of gestational diabetes mellitus. *The Japan Medical Association Journal*. 2011;5:293-300.
82. Blumer I, Hadar E, Hadden DR, Jovanović L, Mestman JH, Murad MH, et al. Diabetes and pregnancy: an endocrine society clinical practice guideline. *The Journal of Clinical Endocrinology & Metabolism*. 2013.
83. Buchanan TA. Pancreatic B-cell defects in gestational diabetes: implications for the pathogenesis and prevention of type 2 diabetes. *The Journal of clinical endocrinology and metabolism*. 2001;86(3):989.
84. Simmons D. Epidemiologic context of diabetes in pregnancy. *A Practical Manual of Diabetes in Pregnancy*. 2010:1-16.

85. Stotland N, Caughey A, Breed E, Escobar G. Risk factors and obstetric complications associated with macrosomia. *International Journal of Gynecology & Obstetrics*. 2004;87(3):220-6.
86. Ornoy A. Prenatal origin of obesity and their complications: Gestational diabetes, maternal overweight and the paradoxical effects of fetal growth restriction and macrosomia. *Reproductive Toxicology*. 2011;32(2):205-12.
87. Boney CM, Verma A, Tucker R, Vohr BR. Metabolic syndrome in childhood: association with birth weight, maternal obesity, and gestational diabetes mellitus. *Pediatrics*. 2005;115(3):e290-e6.
88. Moss JR, Crowther CA, Hiller JE, Willson KJ, Robinson JS. Costs and consequences of treatment for mild gestational diabetes mellitus—evaluation from the ACHOIS randomised trial. *BMC pregnancy and childbirth*. 2007;7(1):27.
89. Fernández-Mejía C. Oxidative Stress in Diabetes Mellitus and the Role Of Vitamins with Antioxidant Actions. *Oxidative Stress And Chronic Degenerative Diseases-A Role For Antioxidants*. 2013:209.
90. Ceriello PA. Oxidative stress and diabetes-associated complications. *Endocrine Practice*. 2006;12(Supplement 1):60-2.
91. Rains JL, Jain SK. Oxidative stress, insulin signaling, and diabetes. *Free Radical Biology and Medicine*. 2011;50(5):567-75.
92. Brownlee M. Biochemistry and molecular cell biology of diabetic complications. *Nature*. 2001;414(6865):813-20.
93. Ceriello A, Quatraro A, Giugliano D. Diabetes mellitus and hypertension: the possible role of hyperglycaemia through oxidative stress. *Diabetologia*. 1993; 36(3):265-6.
94. Maritim A, Sanders R, Watkins rJ. Diabetes, oxidative stress, and antioxidants: a review. *J Biochem Mol Toxicol*. 2003;17(2438.26).
95. Maritim A, Sanders a, Watkins rJ. Diabetes, oxidative stress, and antioxidants: a review. *Journal of biochemical and molecular toxicology*. 2003;17(1):24-38.
96. Guzik TJ, Mussa S, Gastaldi D, Sadowski J, Ratnatunga C, Pillai R, et al. Mechanisms of increased vascular superoxide production in human diabetes mellitus Role of NAD (P) H oxidase and endothelial nitric oxide synthase. *Circulation*. 2002;105(14):1656-62.
97. Ogihara T, Asano T, Katagiri H, Sakoda H, Anai M, Shojima N, et al. Oxidative stress induces insulin resistance by activating the nuclear factor-Kb pathway and disrupting normal subcellular distribution of phosphatidylinositol 3-kinase. *Diabetologia*. 2004;47(5):794-805.
98. Rhodes CJ. Type 2 Diabetes—a Matter of  $\beta$ -Cell Life and Death? *Science*. 2005;307(5708):380-4.
99. Eriksson JW. Metabolic stress in insulin's target cells leads to ROS accumulation—a hypothetical common pathway causing insulin resistance. *FEBS letters*. 2007;581(19):3734-42.
100. Bloch-Damti A, Bashan N. Proposed mechanisms for the induction of insulin resistance by oxidative stress. *Antioxidants & redox signaling*. 2005;7(11-12):1553-67.

101. Brown AJ, Jessup W. Oxysterols: sources, cellular storage and metabolism, and new insights into their roles in cholesterol homeostasis. *Molecular aspects of medicine*. 2009;30(3):111-22.
102. Olkkonen VM, Béaslas O, Nissilä E. Oxysterols and their cellular effectors. *Biomolecules*. 2012;2(1):76-103.
103. Zarrouk A, Vejux A, Mackrill J, O'Callaghan Y, Hammami M, O'Brien N, et al. Involvement of oxysterols in age-related diseases and ageing processes. *Ageing research reviews*. 2014;18:148-62.
104. Björkhem I, Diczfalusy U. Oxysterols Friends, Foes, or Just Fellow Passengers? *Arteriosclerosis, thrombosis, and vascular biology*. 2002;22(5):734-42.
105. Vaya J, Szuchman A, Tavori H, Aluf Y. Oxysterols formation as a reflection of biochemical pathways: summary of in vitro and in vivo studies. *Chemistry and physics of lipids*. 2011;164(6):438-42.
106. Griffiths WJ, Abdel-Khalik J, Crick PJ, Yutuc E, Wang Y. New methods for analysis of oxysterols and related compounds by LC-MS. *The Journal of steroid biochemistry and molecular biology*. 2015.
107. Schroepfer GJ. Oxysterols: modulators of cholesterol metabolism and other processes. *Physiological reviews*. 2000;80(1):361-554.
108. Jessup W, Brown AJ. Novel routes for metabolism of 7-ketocholesterol. *Rejuvenation research*. 2005;8(1):9-12.
109. Iuliano L. Pathways of cholesterol oxidation via non-enzymatic mechanisms. *Chemistry and Physics of Lipids*. 2011;164(6):457-68.
110. Murphy RC, Johnson KM. Cholesterol, reactive oxygen species, and the formation of biologically active mediators. *Journal of Biological Chemistry*. 2008;283(23):15521-5.
111. Luoma PV. Cytochrome P450—physiological key factor against cholesterol accumulation and the atherosclerotic vascular process. *Annals of medicine*. 2007;39(5):359-70.
112. Russell DW. Oxysterol biosynthetic enzymes. *Biochimica et Biophysica Acta (BBA)-Molecular and Cell Biology of Lipids*. 2000;1529(1):126-35.
113. Dyer RG, Stewart MW, Mitcheson J, George K, Alberti M, Laker MF. 7-ketocholesterol, a specific indicator of lipoprotein oxidation, and malondialdehyde in non-insulin dependent diabetes and peripheral vascular disease. *Clinica chimica acta*. 1997;260(1):1-13.
114. Vejux A, Lizard G. Cytotoxic effects of oxysterols associated with human diseases: Induction of cell death (apoptosis and/or oncosis), oxidative and inflammatory activities, and phospholipidosis. *Molecular aspects of medicine*. 2009;30(3):153-70.
115. Gill S, Chow R, Brown AJ. Sterol regulators of cholesterol homeostasis and beyond: the oxysterol hypothesis revisited and revised. *Progress in lipid research*. 2008;47(6):391-404.
116. Björkhem I. Rediscovery of cerebrosterol. *Lipids*. 2007;42(1):5-14.
117. Björkhem I, Eggertsen G. Genes involved in initial steps of bile acid synthesis. *Current opinion in lipidology*. 2001;12(2):97-103.

118. Diczfalusy U, Nylén H, Elander P, Bertilsson L. 4 $\beta$ -hydroxycholesterol, an endogenous marker of CYP3A4/5 activity in humans. *British journal of clinical pharmacology*. 2011;71(2):183-9.
119. Bodin K, Andersson U, Rystedt E, Ellis E, Norlin M, Pikuleva I, et al. Metabolism of 4 $\beta$ -hydroxycholesterol in humans. *Journal of Biological Chemistry*. 2002;277(35):31534-40.
120. Nelson J, Steckbeck S, Spencer T. Biosynthesis of 24, 25-epoxycholesterol from squalene 2, 3; 22, 23-dioxide. *Journal of Biological Chemistry*. 1981;256(3):1067-8.
121. Brown AJ, Leong S, Dean RT, Jessup W. 7-Hydroperoxycholesterol and its products in oxidized low density lipoprotein and human atherosclerotic plaque. *Journal of lipid research*. 1997;38(9):1730-45.
122. Brown AJ, Jessup W. Oxysterols and atherosclerosis. *Atherosclerosis*. 1999;142(1):1-28.
123. Lordan S, Mackrill JJ, O'Brien NM. Oxysterols and mechanisms of apoptotic signaling: implications in the pathology of degenerative diseases. *The Journal of nutritional biochemistry*. 2009;20(5):321-36.
124. Zhang H, Basra H, Steinbrecher UP. Effects of oxidatively modified LDL on cholesterol esterification in cultured macrophages. *Journal of lipid research*. 1990;31(8):1361-9.
125. Otaegui-Arazola A, Menendez-Carreño M, Ansorena D, Astiasaran I. Oxysterols: a world to explore. *Food and Chemical Toxicology*. 2010;48(12):3289-303.
126. Guardiola F. Cholesterol and phytosterol oxidation products: analysis, occurrence, and biological effects: The American Oil Chemists Society; 2002.
127. Krut LH, Yang JW, Schonfeld G, Ostlund Jr RE. The effect of oxidizing cholesterol on gastrointestinal absorption, plasma clearance, tissue distribution, and processing by endothelial cells. *Arteriosclerosis, thrombosis, and vascular biology*. 1997;17(4):778-85.
128. Babiker A, Diczfalusy U. Transport of side-chain oxidized oxysterols in the human circulation. *Biochimica et Biophysica Acta (BBA)-Lipids and Lipid Metabolism*. 1998;1392(2):333-9.
129. Wang J, Megha a, London E. Relationship between sterol/steroid structure and participation in ordered lipid domains (lipid rafts): implications for lipid raft structure and function. *Biochemistry*. 2004;43(4):1010-8.
130. Zhang Y, Yu C, Liu J, Spencer TA, Chang CC, Chang T-Y. Cholesterol is superior to 7-ketocholesterol or 7 $\alpha$ -hydroxycholesterol as an allosteric activator for acyl-coenzyme A: cholesterol acyltransferase 1. *Journal of Biological Chemistry*. 2003;278(13):11642-7.
131. Szedlacsek SE, Wasowicz E, Hulea SA, Nishida HI, Kummerow FA, Nishida T. Esterification of oxysterols by human plasma lecithin-cholesterol acyltransferase. *Journal of Biological Chemistry*. 1995;270(20):11812-9.
132. Javitt NB. Oxysterols: novel biologic roles for the 21st century. *Steroids*. 2008;73(2):149-57.

133. Brown AJ, Watts GF, Burnett JR, Dean RT, Jessup W. Sterol 27-hydroxylase acts on 7-ketocholesterol in human atherosclerotic lesions and macrophages in culture. *Journal of Biological Chemistry*. 2000;275(36):27627-33.
134. Chen W, Chen G, Head DL, Mangelsdorf DJ, Russell DW. Enzymatic reduction of oxysterols impairs LXR signaling in cultured cells and the livers of mice. *Cell metabolism*. 2007;5(1):73-9.
135. Fuda H, Javitt NB, Mitamura K, Ikegawa S, Strott CA. Oxysterols are substrates for cholesterol sulfotransferase. *Journal of lipid research*. 2007;48(6):1343-52.
136. Xu L, Korade Z, Rosado DA, Mirnics K, Porter NA. Metabolism of oxysterols derived from nonenzymatic oxidation of 7-dehydrocholesterol in cells. *Journal of lipid research*. 2013;54(4):1135-43.
137. Jessup W, Gelissen IC, Gaus K, Kritharides L. Roles of ATP binding cassette transporters A1 and G1, scavenger receptor BI and membrane lipid domains in cholesterol export from macrophages. *Current opinion in lipidology*. 2006;17(3):247-57.
138. Ruan B, Wilson WK, Schroepfer GJ. An improved synthesis of (20R, 22R)-cholest-5-ene-3 $\beta$ , 20, 22-triol, an intermediate in steroid hormone formation and an activator of nuclear orphan receptor LXR $\alpha$ . *Steroids*. 1999;64(6):385-95.
139. Leonarduzzi G, Sottero B, Poli G. Oxidized products of cholesterol: dietary and metabolic origin, and proatherosclerotic effects (review). *The Journal of nutritional biochemistry*. 2002;13(12):700-10.
140. Kuver R. Mechanisms of oxysterol-induced disease: insights from the biliary system. 2012.
141. De Boussac H, Alioui A, Viennois E, Dufour J, Trousson A, Vega A, et al. Oxysterol receptors and their therapeutic applications in cancer conditions. *Expert opinion on therapeutic targets*. 2013;17(9):1029-38.
142. Griffiths WJ, Crick PJ, Wang Y. Methods for oxysterol analysis: past, present and future. *Biochemical pharmacology*. 2013;86(1):3-14.
143. Poli G, Biasi F, Leonarduzzi G. Oxysterols in the pathogenesis of major chronic diseases. *Redox biology*. 2013;1(1):125-30.
144. Javitt NB. Oxysteroids: a new class of steroids with autocrine and paracrine functions. *Trends in Endocrinology & Metabolism*. 2004;15(8):393-7.
145. Richardson JA, Amantea CM, Kianmahd B, Tetradis S, Lieberman JR, Hahn TJ, et al. Oxysterol-induced osteoblastic differentiation of pluripotent mesenchymal cells is mediated through a PKC- and PKA-dependent pathway. *Journal of cellular biochemistry*. 2007;100(5):1131-45.
146. Aghaloo TL, Amantea CM, Cowan CM, Richardson JA, Wu BM, Parhami F, et al. Oxysterols enhance osteoblast differentiation in vitro and bone healing in vivo. *Journal of Orthopaedic Research*. 2007;25(11):1488-97.
147. Meynier A, Andre A, Lherminier J, Grandgirard A, Demaison L. Dietary oxysterols induce in vivo toxicity of coronary endothelial and smooth muscle cells. *European journal of nutrition*. 2005;44(7):393-405.



148. Wielkoszyński T, Gawron K, Strzelczyk J, Bodzek P, Zalewska-Ziob M, Trapp G, et al. Cellular toxicity of oxysterols. *Bioessays*. 2006;28(4):387-98.
149. Patra SK. Dissecting lipid raft facilitated cell signaling pathways in cancer. *Biochimica et Biophysica Acta (BBA)-Reviews on Cancer*. 2008;1785(2): 182-206.
150. Ikonen E, Vainio S. Lipid microdomains and insulin resistance: is there a connection? *Sci STKE*. 2005;2005(268):pe3-pe.
151. Olkkonen VM, Hynynen R. Interactions of oxysterols with membranes and proteins. *Molecular aspects of medicine*. 2009;30(3):123-33.
152. Kha HT, Basseri B, Shouhed D, Richardson J, Tetradis S, Hahn TJ, et al. Oxysterols regulate differentiation of mesenchymal stem cells: pro-bone and anti-fat. *Journal of Bone and Mineral Research*. 2004;19(5):830-40.
153. Panini SR, Sinensky MS. Mechanisms of oxysterol-induced apoptosis. *Current opinion in lipidology*. 2001;12(5):529-33.
154. Malvitte L, Montange T, Vejux A, Joffre C, Bron A, Creuzot-Garcher C, et al. Activation of a Caspase-3-Independent Mode of Cell Death Associated with Lysosomal Destabilization in Cultured Human Retinal Pigment Epithelial Cells (ARPE-19) Exposed to 7 $\beta$ -Hydroxycholesterol. *Current eye research*. 2008;33(9):769-81.
155. Li W, Dalen H, Eaton JW, Yuan X-M. Apoptotic death of inflammatory cells in human atheroma. *Arteriosclerosis, thrombosis, and vascular biology*. 2001;21(7):1124-30.
156. Lange Y, Ory DS, Ye J, Lanier MH, Hsu F-F, Steck TL. Effectors of rapid homeostatic responses of endoplasmic reticulum cholesterol and 3-hydroxy-3-methylglutaryl-CoA reductase. *Journal of Biological Chemistry*. 2008;283(3):1445-55.
157. Sever N, Yang T, Brown MS, Goldstein JL, DeBose-Boyd RA. Accelerated degradation of HMG CoA reductase mediated by binding of insig-1 to its sterol-sensing domain. *Molecular cell*. 2003;11(1):25-33.
158. DeBose-Boyd RA, Brown MS, Goldstein JL. Protein Sensors for Membrane Sterols. *Cell*. 2006;124(1):35-46.
159. Radhakrishnan A, Ikeda Y, Kwon HJ, Brown MS, Goldstein JL. Sterol-regulated transport of SREBPs from endoplasmic reticulum to Golgi: oxysterols block transport by binding to Insig. *Proceedings of the National Academy of Sciences*. 2007;104(16):6511-8.
160. Cummins C, Mangelsdorf D. Liver X receptors and cholesterol homeostasis: spotlight on the adrenal gland. *Biochemical Society Transactions*. 2006;34(6):1110-3.
161. Björkhem I, Andersson U, Ellis E, Alvelius G, Ellegård L, Diczfalusy U, et al. From Brain to Bile EVIDENCE THAT CONJUGATION AND  $\omega$ -HYDROXYLATION ARE IMPORTANT FOR ELIMINATION OF 24S-HYDROXYCHOLESTEROL (CEREBROSTEROL) IN HUMANS. *Journal of Biological Chemistry*. 2001;276(40):37004-10.

162. Lum L, Beachy PA. The Hedgehog response network: sensors, switches, and routers. *Science*. 2004;304(5678):1755-9.
163. Dwyer JR, Sever N, Carlson M, Nelson SF, Beachy PA, Parhami F. Oxysterols are novel activators of the hedgehog signaling pathway in pluripotent mesenchymal cells. *Journal of Biological Chemistry*. 2007;282(12):8959-68.
164. Kim WK, Meliton V, Amantea CM, Hahn TJ, Parhami F. 20 (S)-Hydroxycholesterol Inhibits PPAR $\gamma$  Expression and Adipogenic Differentiation of Bone Marrow Stromal Cells Through a Hedgehog-Dependent Mechanism. *Journal of Bone and Mineral Research*. 2007;22(11):1711-9.
165. Vihervaara T, Jansen M, Uronen R-L, Ohsaki Y, Ikonen E, Olkkonen VM. Cytoplasmic oxysterol-binding proteins: sterol sensors or transporters? *Chemistry and physics of lipids*. 2011;164(6):443-50.
166. Prunet C, Montange T, V $\acute{e}$ jux A, Laubriet A, Rohmer JF, Riedinger JM, et al. Multiplexed flow cytometric analyses of pro-and anti-inflammatory cytokines in the culture media of oxysterol-treated human monocytic cells and in the sera of atherosclerotic patients. *Cytometry Part A*. 2006;69(5):359-73.
167. Erridge C, Webb DJ, Spickett CM. 25-Hydroxycholesterol, 7 $\beta$ -hydroxycholesterol and 7-ketocholesterol upregulate interleukin-8 expression independently of Toll-like receptor 1, 2, 4 or 6 signalling in human macrophages. *Free radical research*. 2007;41(3):260-6.
168. Joseph SB, Castrillo A, Laffitte BA, Mangelsdorf DJ, Tontonoz P. Reciprocal regulation of inflammation and lipid metabolism by liver X receptors. *Nature medicine*. 2003;9(2):213-9.
169. Castrillo A, Joseph SB, Marathe C, Mangelsdorf DJ, Tontonoz P. Liver X receptor-dependent repression of matrix metalloproteinase-9 expression in macrophages. *Journal of Biological Chemistry*. 2003;278(12):10443-9.
170. Anticoli S, Arciello M, Mancinetti A, Martinis MD, Ginaldi L, Iuliano L, et al. 7-Ketocholesterol and 5, 6-Secosterol Modulate Differently the Stress-Activated Mitogen-Activated Protein Kinases (MAPKs) in Liver Cells. *Journal of Cellular Physiology*. 2015;230(5):1160-1.
171. Palozza P, Serini S, Verdecchia S, Ameruso M, Trombino S, Picci N, et al. ~~RETRACTED~~: Redox regulation of 7-ketocholesterol-induced apoptosis by  $\beta$ -carotene in human macrophages. *Free Radical Biology and Medicine*. 2007;42(10):1579-90.
172. Kim YJ, Lee CS. Tyrosine kinase inhibitor AG126 reduces 7-ketocholesterol-induced cell death by suppressing mitochondria-mediated apoptotic process. *Neurochemical research*. 2010;35(4):603-12.
173. van Reyk DM, Jessup W. The macrophage in atherosclerosis: modulation of cell function by sterols. *Journal of leukocyte biology*. 1999;66(4):557-61. function by sterols. *Journal of leukocyte biology*. 1999;66(4):557-61.
174. Kulig W, Cwiklik L, Jurkiewicz P, Rog T, Vattulainen I. Cholesterol oxidation products and their biological importance. *Chemistry and physics of lipids*. 2016.

175. van Reyk DM, Brown AJ, Hult'en LM, Dean RT, Jessup W. Oxysterols in biological systems: sources, metabolism and pathophysiological relevance. *Redox Report*. 2013.
176. Kudo K, Emmons G, Casserly E, Via D, Smith L, St Pyrek J, et al. Inhibitors of sterol synthesis. Chromatography of acetate derivatives of oxygenated sterols. *Journal of lipid research*. 1989;30(7):1097-111.
177. Zhang Z, Li D, Blanchard DE, Lear SR, Erickson SK, Spencer TA. Key regulatory oxysterols in liver: analysis as  $\Delta^4$ -3-ketone derivatives by HPLC and response to physiological perturbations. *Journal of lipid research*. 2001;42(4):649-58.
178. Griffiths WJ, Wang Y. Analysis of oxysterol metabolomes. *Biochimica et Biophysica Acta (BBA)-Molecular and Cell Biology of Lipids*. 2011;1811(11):784-99.
179. Dzeletovic S, Breuer O, Lund E, Diczfalusy U. Determination of cholesterol oxidation products in human plasma by isotope dilution-mass spectrometry. *Analytical biochemistry*. 1995;225(1):73-80.
180. Griffiths WJ, Crick PJ, Wang Y, Ogundare M, Tuschl K, Morris AA, et al. Analytical strategies for characterization of oxysterol lipidomes: liver X receptor ligands in plasma. *Free Radical Biology and Medicine*. 2013;59:69-84.
181. Honda A, Yamashita K, Hara T, Ikegami T, Miyazaki T, Shirai M, et al. Highly sensitive quantification of key regulatory oxysterols in biological samples by LC-ESI-MS/MS. *Journal of lipid research*. 2009;50(2):350-7.
182. Burkard I, Rentsch KM, von Eckardstein A. Determination of 24S-and 27-hydroxycholesterol in plasma by high-performance liquid chromatography-mass spectrometry. *Journal of lipid research*. 2004;45(4):776-81.
183. DeBarber AE, Lütjohann D, Merckens L, Steiner RD. Liquid chromatography-tandem mass spectrometry determination of plasma 24S-hydroxycholesterol with chromatographic separation of 25-hydroxycholesterol. *Analytical biochemistry*. 2008;381(1):151-3.
184. Woldegebriel M, Vivó-Truyols G. Probabilistic Model for Untargeted Peak Detection in LC-MS Using Bayesian Statistics. *Analytical chemistry*. 2015;87(14):7345-55.
185. Xiao JF, Zhou B, Ransom HW. Metabolite identification and quantitation in LC-MS/MS-based metabolomics. *TrAC Trends in Analytical Chemistry*. 2012;32:1-14.
186. Banerjee S, Mazumdar S. Electrospray ionization mass spectrometry: a technique to access the information beyond the molecular weight of the analyte. *International journal of analytical chemistry*. 2012;2012.
187. Cech NB, Enke CG. Practical implications of some recent studies in electrospray ionization fundamentals. *Mass Spectrometry Reviews*. 2001;20(6):362-87.
188. Diehl G, Karst U. On-line electrochemistry-MS and related techniques. *Analytical and bioanalytical chemistry*. 2002;373(6):390-8.

189. Cole RB. *Electrospray and MALDI mass spectrometry: fundamentals, instrumentation, practicalities, and biological applications*: John Wiley & Sons; 2011.
190. Fenn JB. Ion formation from charged droplets: roles of geometry, energy, and time. *Journal of the American Society for Mass Spectrometry*. 1993;4(7):524-35.
191. Kebarle P, Peschke M. On the mechanisms by which the charged droplets produced by electrospray lead to gas phase ions. *Analytica Chimica Acta*. 2000;406(1):11-35.
192. Rayleigh L. XX. On the equilibrium of liquid conducting masses charged with electricity. *The London, Edinburgh, and Dublin Philosophical Magazine and Journal of Science*. 1882;14(87):184-6.
193. Nguyen S, Fenn JB. Gas-phase ions of solute species from charged droplets of solutions. *Proceedings of the National Academy of Sciences*. 2007;104(4):1111-7.
194. Hoffmann E. *Mass spectrometry*: Wiley Online Library; 1996.
195. Van Bramer SE. *An introduction to mass spectrometry*. Lecture Notes. 1997.
196. Glish GL, Vachet RW. The basics of mass spectrometry in the twenty-first century. *Nature Reviews Drug Discovery*. 2003;2(2):140-50.
197. Jiang X, Sidhu R, Porter FD, Yanjanin NM, Speak AO, te Vruchte DT, et al. A sensitive and specific LC-MS/MS method for rapid diagnosis of Niemann-Pick C1 disease from human plasma. *Journal of lipid research*. 2011;52(7):1435-45.
198. Adachi J, Tomita M, Yamakawa S, Asano M, Naito T, Ueno Y. 7-Hydroperoxycholesterol as a marker of oxidative stress in rat kidney induced by paraquat. *Free radical research*. 2000;33(3):321-7.
199. Guillemot-Legris O, Mutemberezi V, Muccioli GG. Oxysterols in Metabolic Syndrome: From Bystander Molecules to Bioactive Lipids. *Trends in Molecular Medicine*. 2016.
200. Mullarkey CJ, Edelstein D, Brownlee M. Free radical generation by early glycation products: a mechanism for accelerated atherogenesis in diabetes. *Biochemical and biophysical research communications*. 1990;173(3):932-9.
201. Felice D. Plasma and platelet ascorbate pools and lipid peroxidation in insulin-dependent diabetes mellitus. *European journal of clinical investigation*. 1998;28(8):659-63.
202. Uzel N, Sivas A, Uysal M, Öz H. Erythrocyte lipid peroxidation and glutathione peroxidase activities in patients with diabetes mellitus. *Hormone and metabolic research*. 1987;19(02):89-90.
203. Murakami H, Tamasawa N, Matsui J, Yasujima M, Suda T. Plasma oxysterols and tocopherol in patients with diabetes mellitus and hyperlipidemia. *Lipids*. 2000;35(3):333-8.
204. Endo K, Oyama T, Saiki A, Ban N, Ohira M, Koide N, et al. Determination of serum 7-ketocholesterol concentrations and their relationships with coronary multiple risks in diabetes mellitus. *Diabetes research and clinical practice* 2008;80(1):63-8.

205. Guan J-Z, Murakami H, Yamato K, Tanabe J, Matsui J, Tamasawa N, et al. Effects of fluvastatin in type 2 diabetic patients with hyperlipidemia: reduction in cholesterol oxidation products and VCAM-1. *Journal of atherosclerosis and thrombosis*. 2004;11(2):56-61.
206. Yoshioka N, Adachi J, Ueno Y, Yoshida K-I. Oxysterols increase in diabetic rats. *Free radical research*. 2005;39(3):299-304.
207. Abo K, Mio T, Sumino K. Comparative analysis of plasma and erythrocyte 7-ketocholesterol as a marker for oxidative stress in patients with diabetes mellitus. *Clinical biochemistry*. 2000;33(7):541-7.
208. Menendez-Carreño M, Varo N, Mugueta C, Restituto P, Ansorena D, Astiasaran I. Correlation between serum content of the main COPs (cholesterol oxidation products) from autoxidation and cardiovascular risk factors. 2011.
209. Romeo GR, Kazlauskas A. Oxysterol and diabetes activate STAT3 and control endothelial expression of profilin-1 via OSBP1. *Journal of Biological Chemistry*. 2008;283(15):9595-605.
210. Boumhras M. Evaluation de la toxicité de moules de la Côte Atlantique Marocaine utilisées comme bioindicateurs de contamination: étude in vivo et in vitro sur des rongeurs et des cellules bêta-pancréatiques murines (MIN-6). 2012.
211. Davì G, Falco A, Patrono C. Lipid peroxidation in diabetes mellitus. *Antioxidants & redox signaling*. 2005;7(1-2):256-68.
212. Evans JL, Maddux BA, Goldfine ID. The molecular basis for oxidative stress-induced insulin resistance. *Antioxidants & redox signaling*. 2005;7(7-8):1040-52.
213. Evans JL, Goldfine ID, Maddux BA, Grodsky GM. Oxidative stress and stress-activated signaling pathways: a unifying hypothesis of type 2 diabetes. *Endocrine reviews*. 2002;23(5):599-622.
214. Furukawa S, Fujita T, Shimabukuro M, Iwaki M, Yamada Y, Nakajima Y, et al. Increased oxidative stress in obesity and its impact on metabolic syndrome. *The Journal of clinical investigation*. 2004;114(12):1752-61.
215. Henriksen T, Mahoney EM, Steinberg D. Enhanced macrophage degradation of low density lipoprotein previously incubated with cultured endothelial cells: recognition by receptors for acetylated low density lipoproteins. *Proceedings of the National Academy of Sciences*. 1981;78(10):6499-503.
216. Porkkala-Sarataho E, Salonen JT, Nyssönen K, Kaikkonen J, Salonen R, Ristonmaa U, et al. Long-term effects of vitamin E, vitamin C, and combined supplementation on urinary 7-hydro-8-oxo-2'-deoxyguanosine, serum cholesterol oxidation products, and oxidation resistance of lipids in nondepleted men. *Arteriosclerosis, thrombosis, and vascular biology*. 2000;20(9):2087-93.
217. Quinn MT, Parthasarathy S, Fong LG, Steinberg D. Oxidatively modified low density lipoproteins: a potential role in recruitment and retention of monocyte/macrophages during atherogenesis. *Proceedings of the National Academy of Sciences*. 1987;84(9):2995-8.

218. Tremblay-Franco M, Zerbinati C, Pacelli A, Palmaccio G, Lubrano C, Ducheix S, et al. Effect of obesity and metabolic syndrome on plasma oxysterols and fatty acids in human. *Steroids*. 2015;99:287-92.
219. Alkazemi D, Egeland G, Vaya J, Meltzer S, Kubow S. Oxysterol as a marker of atherogenic dyslipidemia in adolescence. *The Journal of Clinical Endocrinology & Metabolism*. 2008;93(11):4282-9.
220. Deckert V, Brunet A, Lantoine F, Lizard G, Millanvoeye-van Brussel E, Monier S, et al. Inhibition by cholesterol oxides of NO release from human vascular endothelial cells. *Arteriosclerosis, thrombosis, and vascular biology*. 1998;18(7):1054-60.
221. Ferderbar S, Pereira E, Apolinario E, Bertolami M, Faludi A, Monte O, et al. Cholesterol oxides as biomarkers of oxidative stress in type 1 and type 2 diabetes mellitus. *Diabetes/metabolism research and reviews*. 2007;23(1):35-42.
222. Inouye M, Mio T, Sumino K. Glycated hemoglobin and lipid peroxidation in erythrocytes of diabetic patients. *Metabolism*. 1999;48(2):205-9.
223. Reaven GM. The role of insulin resistance and hyperinsulinemia in coronary heart disease. *Metabolism*. 1992;41(5):16-9.
224. Baynes JW, Thorpe SR. The role of oxidative stress in diabetic complications. *Current Opinion in Endocrinology, Diabetes and Obesity*. 1996;3(4):277-84.
225. Mol MJ, de Rijke YB, Demacker PN, Stalenhoef AF. Plasma levels of lipid and cholesterol oxidation products and cytokines in diabetes mellitus and cigarette smoking: effects of vitamin E treatment. *Atherosclerosis*. 1997;129(2):169-76.
226. Eliasson B. Cigarette smoking and diabetes. *Progress in cardiovascular diseases*. 2003;45(5):405-13.



**T.C.**  
**HACETTEPE ÜNİVERSİTESİ**  
Girişimsel Olmayan Klinik Araştırmalar Etik Kurulu

Sayı : 16969557-1117

**ARAŞTIRMA PROJESİ DEĞERLENDİRME RAPORU**

**Toplantı Tarihi** : 21.10.2015 ÇARŞAMBA  
**Toplantı No** : 2015/21  
**Proje No** : GO 15/662 (Değerlendirme Tarihi: 21.10.2015)  
**Karar No** : GO 15/662 - 25

Üniversitemiz Tıp Fakültesi Biyokimya Anabilim Dalı öğretim üyelerinden Doç. Dr. İncilay LAY'ın sorumlu araştırmacı olduğu, Prof. Dr. Filiz AKBIYIK, Prof. Dr. Alper GÜRLEK, Uzm. Dr. Süleyman Nahit ŞENDUR ve Dr. Sevilay KARAHAN ile birlikte çalışacakları, Dr. Afshin SAMADI'nin tezi olan GO 15/662 kayıt numaralı ve "TİP 1 ve TİP 2 Diabetes Mellitusta Oksisterol Türlerinin LC-MS/MS Yöntemi ile İncelenmesi" başlıklı proje önerisi araştırmannın gerekçe, amaç, yaklaşım ve yöntemleri dikkate alınarak incelenmiş olup, etik açıdan uygun bulunmuştur.

- |   |  |
|---|--|
| 1. Prof. Dr. Nurten Akarsu (Başkan)     | 9 Prof. Dr. Rahime Nohutçu (Üye)           |
| 2. Prof. Dr. Nüket Örnek Buken (Üye)    | 10. Prof. Dr. R. Köksal Özgül (Üye)        |
| 3. Prof. Dr. M. Yıldırım Sara (Üye)     | 11. Prof. Dr. Ayşe Lale Doğan (Üye)        |
| 4. Prof. Dr. Sevdâ F. Müftüoğlu (Üye)   | 12. Prof. Dr. Leyla Dinç (Üye)             |
| 5. Prof. Dr. Cenk Sökmenşüer (Üye)      | 13. Prof. Dr. Hatice Doğan Buzoğlu (Üye)   |
| 6. Prof. Dr. Volga Bayrakçı Tunay (Üye) | 14. Doç. Dr. S. Kutay Demirkan (Üye)       |
| 7. Prof. Dr. Ali Düzova (Üye)           | 15. Yrd. Doç. Dr. H. Hüsrev Turnagöl (Üye) |
| 8. Prof. Dr. Levent Akın (Üye)          | 16. Av. Meltem Onurlu (Üye)                |

## CURRICULUM VITAE



## 1. General

<b>Date of issue</b>	25.01.2017		
<b>Name and Surname:</b>	Afshin Samadi		
<b>Address for Correspondence:</b>	1. Kucuk Esat Basak Alley, No 29/2. Ankara/Turkey. 2. Hacettepe University Faculty of Medicine, Department of Medical Biochemistry, 06100 Ankara/Turkey		
<b>Date and Place of Birth:</b>	03/08/1984 – IRAN		
<b>Tel:</b>	+903123051652	<b>GSM:</b>	+905319311984
<b>Email:</b>	Samadi.afshin84@yahoo.com Afshin.samadi@hacettepe.edu.tr		
<b>Present position:</b> Research Assistant-PhD, Hacettepe University Faculty of Medicine Department of Medical Biochemistry			
<b>Contact information:</b> Hacettepe University Faculty of Medicine, Department of Medical Biochemistry, 06100 Ankara, Turkey.			

## 2. Education

<b>Master of science (DVM)</b>	Faculty of Veterinary Medicine, Islamic Azad University, Urmiya-Iran 2002-2008
<b>Ph.D</b>	Hacettepe University, Medical Biochemistry 2011 up to 2016



