

**INVESTIGATING THE USE OF WATER FOR ELECTRICITY
GENERATION AT TURKISH POWER PLANTS**

**TÜRK ELEKTRİK SANTRALLERİNDE ELEKTRİK ÜRETİMİ
İÇİN SU KULLANIMININ İNCELENMESİ**

Balkess D. J. EL-KHOZONDAR

Assoc. Prof. Dr. MERİH AYDINALP KÖKSAL
Supervisor

**Submitted to Graduate School of Science and Engineering of Hacettepe
University as a Partial Fulfillment to the Requirements
for the Award of the Degree of Master of Science
in Environmental Engineering**

2017

This work named "Investigating the Use of Water for Electricity Generation at Turkish Power Plants" by "BALKESS D. J. EL-KHOZONDA" has been approved as a thesis for the Degree of **MASTER OF SCIENCE IN ENVIRONMENTAL ENGINEERING** by the below mentioned Examining Committee Members.

Prof. Dr. Gülen GÜLLÜ

Head

.....
Gülen Güllü

Assoc. Prof. Dr. Merih AYDINALP KÓKSAL

Supervisor

.....
Merih Aydınalp Kóksal

Assoc. Prof. Dr. Emre ALP

Member

.....
Emre Alp

Assoc. Prof. Dr. Şule ERGÜN

Member

.....
Şule Ergün

Assist. Prof. Dr. Hatice ŞENGÖL

Member

.....
Hatice Şengöl

This thesis has been approved as a thesis for the degree of **MASTER OF SCIENCE IN ENVIRONMENTAL ENGINEERING** by Board of Directors of the Institute for Graduate School of Science and Engineering.

Prof. Dr. Menemşe GÜMÜŞDERELİOĞLU

Director of the Institute of

Graduate School of Science and Engineering

YAYINLAMA VE FİKRİ MÜLKİYET HAKLARI BEYANI

Enstitü tarafından onaylanan lisansüstü tezimin/raporumun tamamını veya herhangi bir kısmını, basılı (kağıt) ve elektronik formatta arşivleme ve aşağıda verilen koşullarla kullanıma açma iznini Hacettepe üniversitesine verdiğimi bildiririm. Bu izinle Üniversiteye verilen kullanım hakları dışındaki tüm fikri mülkiyet haklarım bende kalacak, tezimin tamamının ya da bir bölümünün gelecekteki çalışmalarda (makale, kitap, lisans ve patent vb.) kullanım hakları bana ait olacaktır.

Tezin kendi orijinal çalışmam olduğunu, başkalarının haklarını ihlal etmediğimi ve tezimin tek yetkili sahibi olduğumu beyan ve taahhüt ederim. Tezimde yer alan telif hakkı bulunan ve sahiplerinden yazılı izin alınarak kullanması zorunlu metinlerin yazılı izin alarak kullandığımı ve istenildiğinde suretlerini Üniversiteye teslim etmeyi taahhüt ederim.

- Tezimin/Raporumun tamamı dünya çapında erişime açılabilir ve bir kısmı veya tamamının fotokopisi alınabilir.**

(Bu seçenkle teziniz arama motorlarında indekslenebilecek, daha sonra tezinizin erişim statüsünün değiştirilmesini talep etmeniz ve kütüphane bu talebinizi yerine getirirse bile, tezinin arama motorlarının önbelleklerinde kalmaya devam edebilecektir.)

- Tezimin/Raporumun tarihine kadar erişime açılmasını ve fotokopi alınmasını (İç Kapak, Özet, İçindekiler ve Kaynakça hariç) istemiyorum.**

(Bu sürenin sonunda uzatma için başvuruda bulunmadığım takdirde, tezimin/raporumun tamamı her yerden erişime açılabilir, kaynak gösterilmek şartıyla bir kısmı ve ya tamamının fotokopisi alınabilir)

- Tezimin/Raporumun tarihine kadar erişime açılmasını istemiyorum, ancak kaynak gösterilmek şartıyla bir kısmı veya tamamının fotokopisinin alınmasını onaylıyorum.**

- Serbest Seçenek/Yazarın Seçimi**

08.06.2017

(İmza)

Öğrencinin Adı Soyadı

Balkes El-Khozondar

Balkes

ETHICAL STATEMENT

In this thesis study, prepared in accordance with the spelling rules of Institute of Graduate School in Science and Engineering of Hacettepe University,

I declare that

- All the information and documents have been obtained in the base of the academic rules.
- All audio-visual and written information and results have been presented according to the scientific ethics.
- In case of using others Works, related studies have been cited in accordance with the scientific standards.
- All cited studies have been fully referenced.
- I did not do any distortion in the data set.

And any part of this thesis has not been presented as another thesis study at this or any other university.

8/06/2017

Balkess D. J. EL-KHOZONDAR



ABSTRACT

INVESTIGATING THE USE OF WATER FOR ELECTRICITY GENERATION AT TURKISH POWER PLANTS

Balkess D. J. EL-KHOZONDAR

Master of Science, Department of Environmental Engineering

Supervisor: Assoc. Prof. Dr. MERİH AYDINALP KÖKSAL

June, 2017

The water-energy intertwined relationship has recently gained more importance due to the high water consumption in the energy sector and to the limited availability of the water resources. The energy production is a water intensive process in which water is consumed for fuel extraction, fuel processing, and electricity generation which results in the largest share of water consumption among other processes. Thus, investigating the amount of water consumed during electricity generation at power plants has become an important issue in energy-water nexus.

The energy and electricity demand of Turkey has been increasing rapidly in the last two decades. More thermal power plants are expected to be built in the near future to supply the rapidly increasing electricity demand in Turkey. In this study, the water consumption for electricity generation at the Turkish power plants is investigated. The main objectives of this study are to identify the amount of water consumed to generate 1 GWh of electricity for each fuel type currently used in Turkey and to investigate ways to reduce the water consumption at power plants expected to be built in the near future to supply the increasing demand.

In the first stage of the study, installed capacity, fuel and technology types, electricity generation, and if available cooling system type data of over 1500 power plants, cooling-system water consumption factors, renewable energy potential, and electricity demand forecasts are gathered from various sources. Then, the data are analyzed to determine the water consumption of the current power plants, and the total and per generation water consumption at Turkish electricity sector in 2016. The analysis resulted that based on the installed capacity 44% of the power plants use wet cooling towers as their cooling system type, which consume more water than once through or dry cooling systems. Also coal/lignite fueled power plants consume 71% of the total water consumed at electricity generation in 2016 which is determined as 188 million m³. The analyses also show that the 693 m³ of water is consumed at cooling systems of the power plants to generate 1 GWh of electricity in 2016.

In the next stage of the study, the various scenarios based on fuel types mixture are analyzed to determine the total and per generation water consumption and savings. The Long-range Energy Alternatives Planning (LEAP) program is used to determine the fuel type mixtures resulting in the minimum water consumption using optimization approaches between 2017 and 2035. Based on the comparison of the water consumption resulted in all scenarios, the wet cooling tower based scenarios have the highest amount. Whereas, the dry cooling system based scenarios achieve the lowest water consumption among the other scenarios. The scenario which assumes that the dry cooling systems are preferred more than the other systems, where available, results in reductions of 45% and 40% in 2016 and 2035, respectively.

Keywords: Water consumption, Water intensity, Electricity generation, Cooling systems, LEAP.

ÖZET

TÜRK ELEKTRİK SANTRALLERİNDE ELEKTRİK ÜRETİMİ İÇİN SU KULLANIMININ İNCELENMESİ

Balkess D. J. EL-KHOZONDAR

Yüksek Lisans, Çevre Mühendisliği Bölümü

Danışman: Doç. Dr. MERİH AYDINALP KÖKSAL

Haziran, 2017

Enerji sektöründe su tüketiminin yüksek olması ve su kaynaklarına erişimin sınırlı düzeyde olması nedeniyle su ve enerjinin karşılıklı ilişkisi son zamanlarda daha da önem kazanmıştır. Enerji üretimi suyun kullanımı yoğun olan bir süreçtir, ve su yakıt ekstraksiyonu, yakıt imalatı ve elektrik üretimi işlemlerinde yoğun şekilde kullanılmaktadır. Bunlar arasında elektrik üretimi suyun en yoğun kullanıldığı prosestir. Bu nedenle, elektrik santrallerinde elektrik üretimi sırasında tüketilen su miktarının araştırılması enerji-su bağlantısı içinde önemli bir konu haline gelmiştir.

Son yirmi yıldır, Türkiye'nin enerji ve elektrik talebi hızla artmaktadır. Türkiye'de hızla artan elektrik talebini karşılamak için yakın gelecekte daha fazla termik santral inşa edilmesi beklenmektedir. Bu çalışmada, Türkiye'de bulunan elektrik santrallerindeki elektrik üretimi için gereken su tüketimi araştırılmıştır. Bu çalışmanın temel amaçları; Türkiye'de halihazırda kullanılan her yakıt türü bazında 1 GWh elektrik üretmek için tüketilen su miktarını belirlemek ve artan talebi karşılamak için yakın gelecekte inşa edilmesi beklenen santrallerdeki su tüketimini azaltmanın yollarını araştırmaktır.

Çalışmanın ilk aşamasında; 1500'den fazla elektrik santrali için kurulu güç, yakıt ve teknoloji türleri, elektrik üretimi ve - eğer ulaşılabilmişse - soğutma sistemi tipi bilgileri temin edilmiş, soğutma sistemi su tüketimi faktörleri, yenilenebilir enerji potansiyeli ve elektrik talebi tahminleri çeşitli kaynaklardan toplanmıştır. Daha sonra veriler, mevcut elektrik santrallerinin su tüketimini ve 2016 yılında Türk elektrik sektöründeki toplam ve üretim başına su tüketimini belirlemek için analiz edilmiştir. Kurulu güce dayalı analiz sonuçlarına göre, santrallerin %44'ü soğutma sistemi olarak açık devre veya kuru soğutma sistemine göre daha çok su tüketen, ıslak soğutma kulelerini kullanmaktadır. Ayrıca, kömür/linyit yakıtlı elektrik santralleri, 2016 yılı elektrik üretiminde kullanılan toplam 188 milyon m³ suyun %71'ini tükettiği belirlenmiştir. Analizler aynı zamanda, 2016 yılında 1 GWh elektrik üretmek için santrallerin soğutma sistemlerinde 693 m³ suyun tüketildiğini göstermektedir.

Çalışmanın bir sonraki aşamasında, yakıt türü karışımlarına dayalı çeşitli senaryolar ile toplam ve üretim başına su tüketimi ve tasarrufunu belirlemek için analizler yapılmıştır. Uzun Vadeli Enerji Alternatifleri Planlama (LEAP) programı kullanılarak 2017 ve 2035 yılları arasındaki en az su tüketimi sağlayan yakıt karışımı türü optimizasyon yaklaşımları ile belirlenmiştir. Uygulanan tüm senaryolardaki su tüketimi sonuçları karşılaştırıldığında, ıslak soğutma kulesi tabanlı senaryolar en yüksek miktarda su tüketimlerine yol açtıkları belirlenmiştir. Buna karşın, kuru soğutma sistemi tabanlı senaryolar, diğer senaryolar içinde en düşük su tüketimini sağladığı tespit edilmiştir. Kuru soğutma sistemlerinin diğer sistemlere göre daha çok tercih edildiği kabul edilen senaryoya göre 2016 ve 2035 yıllarında su tüketimlerinde sırası ile %45 ve %40 düşüş olabileceği tespit edilmiştir.

Anahtar Kelimeler: Su tüketimi, Su yoğunluğu, Elektrik üretimi, Soğutma sistemleri, LEAP.

ACKNOWLEDGEMENTS

First of all, I am deeply grateful to my beloved parents Dr. DIAELDEEN ELKHOZONDAR and MANAL ELKHOZONDAR who do not stop to support and encourage me. My husband MOTASEM ALWAZIR thanks for your patience, help, support and infinity love.

To my valuable adviser who guides and encourages me with her vast experience and knowledge at every stage of my thesis work Assoc. Prof. Dr. MERİH AYDINALP KÖKSAL thanks very much.

To my family and friends in Palestine, thanks for the infinity love and support. At the same time, Hacettepe University Department of Environmental Engineering I would like to thank to the valuable faculty members Prof Dr. A. Cemal SAYDAM, Prof. Dr. Gülen GÜLLÜ, Assoc. Dr. Selim L. SANİN, and Assist. Prof. Dr. Hatice ŞENGÜL.

Ezgi Ogun, my friend always helped me in translating difficult things from Turkish, special thanks to you. I would like to thank Adeleh Rashidi, she always supported me in the difficult times and encouraged me.

I would like to thank Turkish Government for providing me the chance to study in Turkey and supporting me by the scholarship.

I would like to thank my friend Gordhan Valasai for his contribution and support for my thesis work.

TABLE OF CONTENTS

ABSTRACT	i
ÖZET	iii
ACKNOWLEDGEMENTS.....	v
TABLE OF CONTENTS	vi
LIST OF FIGURES.....	x
LIST OF TABLES	xii
ABBREVIATIONS AND SYMBOLS.....	xiv
Abbreviations	xiv
Symbols	xiv
Greek Letters	xvi
1 INTRODUCTION.....	1
1.1 Background	1
1.2 Information on Turkish Electricity Sector	1
1.3 Water Consumption in Turkey	4
1.4 Problem Definition	4
1.5 Objective of the Thesis	5
1.6 Scope of the Thesis	5
1.7 Structure of the Thesis.....	6
2 WATER AND ENERGY NEXUS	7
2.1 Energy for Water.....	7
2.1.1 Water Services	8
2.1.2 Water End Use	8
2.2 Water for Energy.....	9
2.2.1 Fuel Production	9

2.2.2	Water Used for Fuel Processing.....	10
2.2.3	Water Used for Electricity Generation	11
2.3	Closing Remarks	11
3	WATER CONSUMPTION AT THERMOELECTRIC POWER PLANTS	12
3.1	Renewable Energy Power Plants	13
3.2	Nuclear Power Plants	14
3.3	Fossil Fueled Power Plants	14
3.4	Cooling Systems of Rankine Cycle.....	15
3.4.1	Once Through Cooling System (OTCS)	17
3.4.2	Wet Tower Cooling System (WTCS)	18
3.4.3	Dry Cooling System.....	19
3.5	Closing Remarks	20
4	PREVIOUS STUDIES	21
4.1	Studies on Determining Water Consumption Factors	21
4.2	Studies on Forecasting the Water Consumption and Intensity	28
4.3	Studies on Electricity Mixture Optimization.....	30
4.4	Studies on Water Consumption Reduction	30
4.5	Closing Remarks	32
5	METHODOLOGY AND DATA SOURCES	33
5.1	Data Gathering and Analysis	33
5.1.1	Power Plant Data.....	34
5.1.2	Renewable Energy Potential Data.....	36
5.1.3	Electricity Demand Forecast Data	36
5.1.4	Cooling System Types.....	37
5.1.5	Water Consumption and Factors (WCF)	39
5.1.6	Total Water Consumption and Water Intensity (WI)	40

5.2	Model Development.....	40
5.2.1	Building the Baseline of the Model	42
5.3	Scenario Application.....	43
5.3.1	Scenarios Description.....	43
5.3.2	An Overview of Scenarios	51
5.4	Closing Remarks	51
6	RESULTS AND DISCUSSIONS	52
6.1	Current Status in Turkey.....	52
6.2	Fuel Share Distribution of the Scenarios	55
6.2.1	BAU Based Scenarios.....	55
6.2.2	Optimization Based Scenarios	56
6.3	Water Consumptions and Intensities	58
6.3.1	BAU Scenario.....	59
6.3.2	OPT Scenario.....	60
6.3.3	DCS_BAU Scenario	62
6.3.4	DCS_OPT Scenario	64
6.3.5	WCT_BAU Scenario.....	66
6.3.6	WCT_OPT Scenario.....	68
6.3.7	OTCS_BAU Scenario	70
6.3.8	OTCS_OPT Scenario	72
6.3.9	HDCS_BAU Scenario.....	74
6.3.10	HDCS_OPT Scenario.....	76
6.3.11	Comparison of the Results of the Scenarios	77
6.4	Closing Remarks	79
7	Conclusion and Recommendations.....	81
7.1	Suggestions for Future Work.....	85

REFERENCES.....	87
APPENDICES	96
Appendix A.....	97
Calculated Capacities based on Generation Technologies in Turkey for BAU Scenario.....	97
Appendix B.....	101
Water Intensities of the Applied Scenarios.....	101

LIST OF FIGURES

Figure 1.1	Installed capacity between 1970–2016 based on fuel type	2
Figure 1.2	Electricity generation between 1970 – 2016 based on fuel type	3
Figure 1.3	Installed capacity and electricity generation by fuel type in 2016	3
Figure 1.4	Annual industrial and domestic water consumption between 2004 and 2014.....	4
Figure 2.1	Water-energy nexus.....	7
Figure 2.2	Energy demand of water systems	8
Figure 3.1	Rankine cycle.....	12
Figure 3.2	Brayton cycle.....	13
Figure 3.3	Once through cooling system	17
Figure 3.4	Closed Cycle Cooling System	18
Figure 3.5	Schematic of direct dry cooling system	19
Figure 3.6	indirect dry cooling system	19
Figure 3.7	Schematic of the Heller system	20
Figure 5.1	Methodology of the study	33
Figure 5.2	Flow chart of LEAP structure [16].....	41
Figure 5.3	Generation fuel type modules defined on LEAP.....	42
Figure 6.1	Annual electricity generation shares based on the BAU scenarios (BAU, DCS_BAU, WCTS_BAU, OTCS_BAU and HDCS_BAU).....	56
Figure 6.2	Annual electricity generation shares for the OPT, WCTS_OPT, OTCS_OPT and HDCS_OPT scenarios.....	57
Figure 6.3	Annual electricity generation share for the DCS_OPT scenario	58
Figure 6.4	Water Consumption for the BAU Scenario	59
Figure 6.5	Water Intensities for the BAU Scenario	60
Figure 6.6	Water consumption (million m ³) for the OPT Scenario	61

Figure 6.7	Water Intensities (m ³ /GWh) for the OPT Scenario	62
Figure 6.8	Water Consumption for the DCS_BAU Scenario	63
Figure 6.9	Water Intensities for the DCS_BAU Scenario	64
Figure 6.10	Water Consumption for the DCS_OPT Scenario	65
Figure 6.11	Water Intensities for the DCS_BAU Scenario	66
Figure 6.12	Water Consumption for the WCT_BAU Scenario	67
Figure 6.13	Water Intensities for the WCT_BAU Scenario	68
Figure 6.14	Water Consumption for the WCT_OPT Scenario	69
Figure 6.15	Water Intensities for the WCT_OPT Scenario	70
Figure 6.16	Water Consumption for the OTCS_BAU Scenario	71
Figure 6.17	Water Intensities for the OTCS_BAU Scenario	72
Figure 6.18	Water Consumption for the OTCS_OPT Scenario	73
Figure 6.19	Water Intensities for the OTCS_OPT Scenario	73
Figure 6.20	Water Consumption for the HDCS_BAU Scenario	75
Figure 6.21	Water Intensities for the HDCS_BAU Scenario	75
Figure 6.22	Water Consumption for the HDCS_OPT Scenario	76
Figure 6.23	Water Intensities for the HDCS_OPT Scenario	77
Figure 6.24	Total water consumption difference between the BAU scenario and the other applied scenarios over the study period (2016-2035).....	78
Figure 6.25	WI of the applied scenarios over the study period.....	78

LIST OF TABLES

Table 3.1	Thermodynamic characteristics and thermal capacities of different cooling systems in the power industry.....	16
Table 4.1	The water consumption factors (WCF) from the earlier studies (m ³ /GWh).....	25
Table 5.1	Turkish power plants data in 2016.....	35
Table 5.2	Annual operation increase of expected nuclear power plants.....	35
Table 5.3	Potential of renewable energy resources in Turkey.....	36
Table 5.4	Electricity demand estimations (GWh) in Turkey.....	36
Table 5.5	Cooling systems based on thermal heat input (MW _{th}), thermal efficiency, and installed capacity (MW).....	38
Table 5.6	Water consumption factors used in this study.....	39
Table 5.7	Business as Usual (BAU) and optimization (OPT) scenarios water consumption factors.....	44
Table 5.8	Water consumption factor for DCS_BAU and DCS_OPT Scenario.....	47
Table 5.9	WCT_BAU and WCT_OPT water consumption factors.....	48
Table 5.10	OTCS_BAU and OTCS_OPT water consumption factors.....	49
Table 5.11	Weighted average water consumption factor (WCF) in HDCS Scenario.....	50
Table 5.12	HDCS_BAU and HDCS_OPT water consumption factors.....	50
Table 5.13	LEAP Scenarios.....	51
Table 6.1	Cooling system distribution based on number of power plants for each fuel type in 2016.....	53
Table 6.2	Cooling system distribution based on installed capacities for each fuel type in 2016.....	53
Table 6.3	Water consumption, and water consumption intensity (WI) in 2016.....	54

Table 6.4	Annual electricity generation shares for the BAU based scenarios (BAU, DCS_BAU, WCTS_BAU, OTCS_BAU and HDCS_BAU).....	55
Table 6.5	Annual electricity generation shares for the OPT, WCTS_OPT, OTCS_OPT and HDCS_OPT scenarios.....	56
Table 6.6	Annual electricity generation share for the DCS_OPT scenario.....	58
Table 6.7	Water consumption (million m ³) based on the BAU Scenario.....	59
Table 6.8	Water consumption (million m ³) based on the OPT Scenario.....	61
Table 6.9	Water consumption (million m ³) based on the DCS_BAU Scenario.....	62
Table 6.10	Water consumption (million m ³) based on the DCS_OPT Scenario.....	65
Table 6.11	Water consumption (million m ³) based on the WCT_BAU Scenario.....	66
Table 6.12	Water consumption (million m ³) based on the WCT_OPT Scenario.....	68
Table 6.13	Water consumption (million m ³) based on the OTCS_BAU Scenario.....	70
Table 6.14	Water consumption (million m ³) based on the OTCS_OPT Scenario.....	72
Table 6.15	Water consumption (million m ³) based on the HDCS_BAU Scenario.....	74
Table 6.16	Water consumption (million m ³) based on the HDCS_OPT Scenario.....	76
Table 7.1	Total water consumption difference between the BAU scenario and the other applied scenarios over the study period (2016-2035).....	83

ABBREVIATIONS AND SYMBOLS

Abbreviations

BWRs	Boiling Water Reactors
CSP	Concentrated Solar Power
DCS	Dry Cooling System
DOE	U.S. Department of Energy
EIA	U.S. Department of Energy Information Administration
EIA	US Energy Information administration
EPRI	Electric Power Research Institute
GCAM	Global Change Assessment Model
GHG	greenhouse gases
LEAP	Long Rang Energy Alternative Planning
LEAP	Long Range Energy Alternative Planning
NGCC	Natural Gas Combined Cycle
NREL	National Renewable Energy Laboratory
OTCS	Once Through Cooling System
PV	Photovoltaic
PWRs	Pressurized Water Reactor
USGS	U.S. Geological survey
WTCS	Wet Tower Cooling System

Symbols

<i>CC</i>	Capital cost (U.S. Dollar/MW)
<i>CI</i>	Capital investment (U.S. Dollar)

<i>DCI</i>	Discount capital investment (U.S. Dollar)
<i>DF</i>	Discount factor
<i>DOC</i>	Discount operating cost (U.S. Dollar)
<i>OC</i>	Operating cost (U.S. Dollar)
<i>SV</i>	Salvage value(U.S. Dollar)
<i>TDC</i>	Total discount cost for each technology over the year(U.S. Dollar)
<i>VC</i>	Variable cost(U.S. Dollar/GWh)
<i>AFOC</i>	Annual fixed operating cost (U.S. Dollar)
<i>AVOC</i>	Annual variable operational cost (U.S. Dollar) []
<i>CF</i>	Capacity factor
f_v	Wind speed function [kg/s-m ² -Pa]
<i>GEN</i>	Annual generation (GWh)
h_{fg}	Latent heat of vaporization of water [MJ/kg]
<i>i</i>	Power plant with specific cooling system in each generation technology
<i>IC</i>	Installed capacity (GW)
<i>j</i>	The power plant with specific generation technology
k_{lat}	Fraction of latent heat rejected
<i>M</i>	Number of power plant with specific cooling system in each generation technology
<i>N</i>	Number of power plant with specific generation technology
<i>PPWC</i>	Water consumption of thermoelectric power plants (m ³)
<i>TE</i>	Thermal efficiency
<i>THI</i>	Thermal heat input (MW _{th})
T_s	Surface temperature [K]
<i>WCF</i>	Water consumption factors (m ³ /GWh)
<i>WI</i>	W water intensity (m ³ /GWh)
\dot{W}_{evap}	Rate of water consumption [kg/s]
<i>t</i>	Fuel type

y	year
SF	Salvage factor
\dot{Q}_{load}	Amount of heat rejected [MJ/s]
LCE	Least cost electricity generation

Greek Letters

γ	Psychometric constant [Pa/K]
ε	Emissivity of the water surface and assumed as 0.9
σ	Stefan-Boltzmann constant which is $5.67 \times 10^{-14} \text{ MJ/m}^2\text{-s-K}^4$
β	Thermodynamically constant function [Pa/K]

1 INTRODUCTION

In this chapter, the first section provides general information about the water-energy relationship. Then, some background information on Turkish electricity sector is presented in the next section. Total water consumption and sectoral distribution in Turkey are provided in the following section. Finally, the problem, aim, scope, and structure of this study are presented.

1.1 Background

The global demand for energy and for electricity increase mainly due to the increase in population. As a result, the electricity generation has to be increased to meet the demand. Electricity generation is a water-intensive process in which water is used in many areas such as fuel extraction, fuel processing, and electricity generation. Processes such as water treatment, desalination, water transportation, and pumping require energy to provide water services. The energy and water related processes closely interacted, thus this interaction is called water-energy nexus.

The demand for electricity is continuously increasing and this results in an increase in the amount of water consumed in electricity generation process. The amount of water consumption depends on the technologies used at the power plants. The majority of the global electricity is generated at thermoelectric power plants which use a significant amount of water, especially at the cooling systems. Once through, wet closed loop, and dry cooling are the most common cooling systems used at thermoelectric power plants [1].

1.2 Information on Turkish Electricity Sector

The electricity consumption in Turkey reached to 270,525,939 MWh and installed capacity reached to 75,672 MW in 2016 according to the Turkish Electricity Transmission Corporation (TEIAS) [2]. Figure 1.1 presents the installed capacity for the electricity generation in Turkey between 1970 and 2016 based on the fuel type. As can be seen from the figure, the installed capacity of the hydropower increased

by almost three times from 1970 till 2016. The natural gas fueled power plants started to operate in 1990's and natural gas installed capacity share increased to 32% in 2016. The installed capacities of the lignite and hard coal also increased by almost two times between 1970 and 2016 [2] [3].

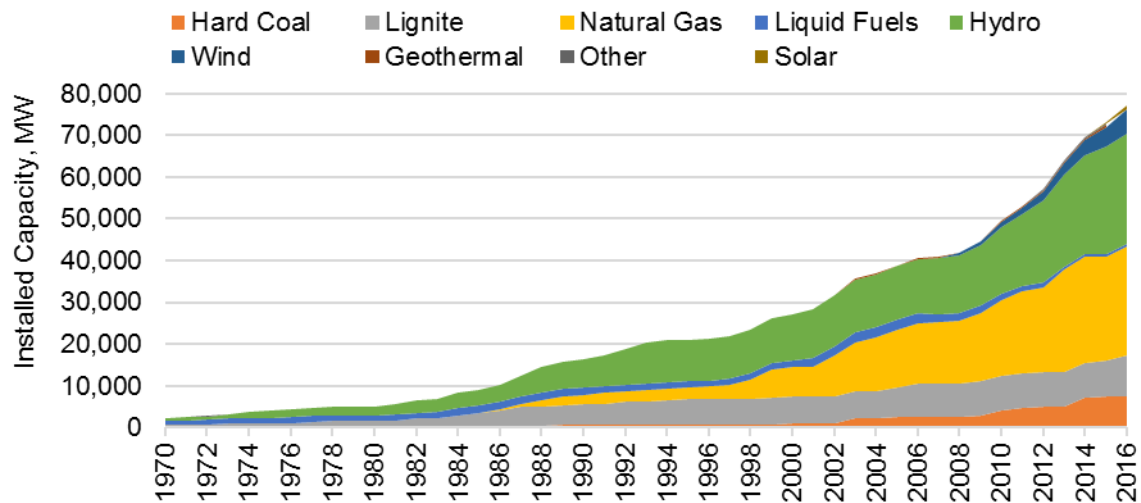

Figure 1.1 Installed capacity between 1970–2016 based on fuel type [2]

The electricity generation based on primary energy sources between 1970 and 2016 is given in Figure 1.2. As can be seen in Figure 1.2 , between 1970 and 1985, hydropower and coal /lignite are used as primary energy sources for electricity generation. From 1985 to 2016, there is a large increase in electricity production of fossil fueled power plants. This increase is mainly due to the increase of electricity generation at power plants fueled with natural gas. The import of natural gas started in 1985 and its use increased dramatically [2].

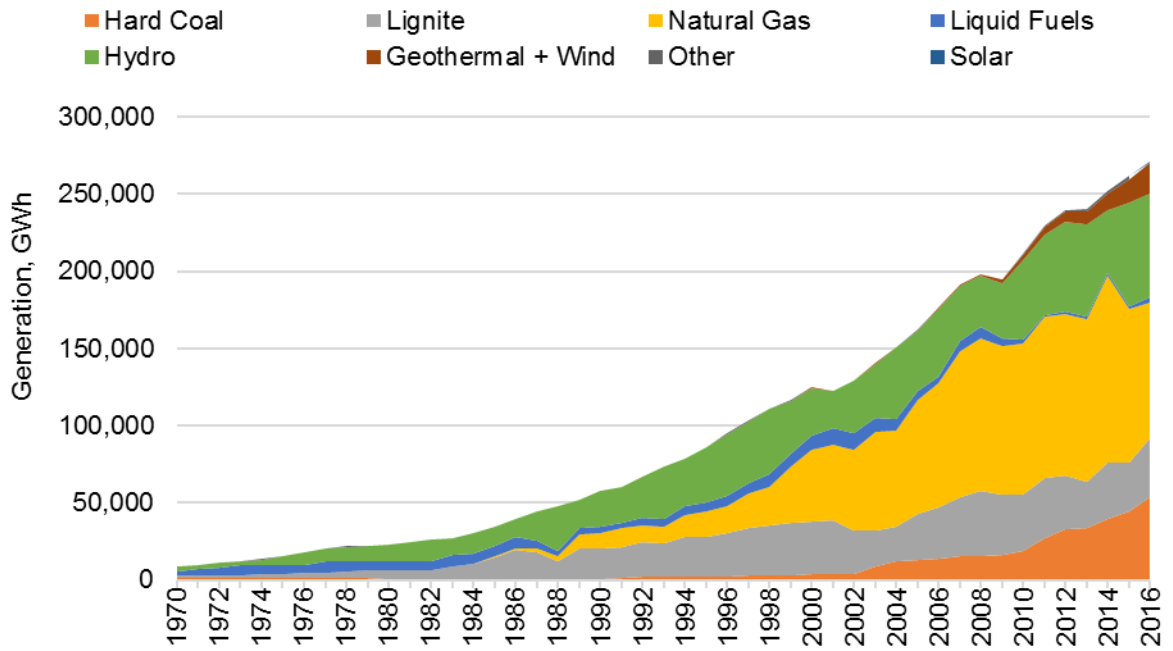

Figure 1.2 Electricity generation between 1970 – 2016 based on fuel type [2]

The shares of the fuels in the generation and installed capacity are given in Figure 1.3. As it can be seen here, even though renewable energies share in installed capacity was 43 % in 2016, their share in the generation was 32%. This is mainly due to the increase of the share of the coal fueled power plants in the generation, and the decrease of hydro power plants [2].

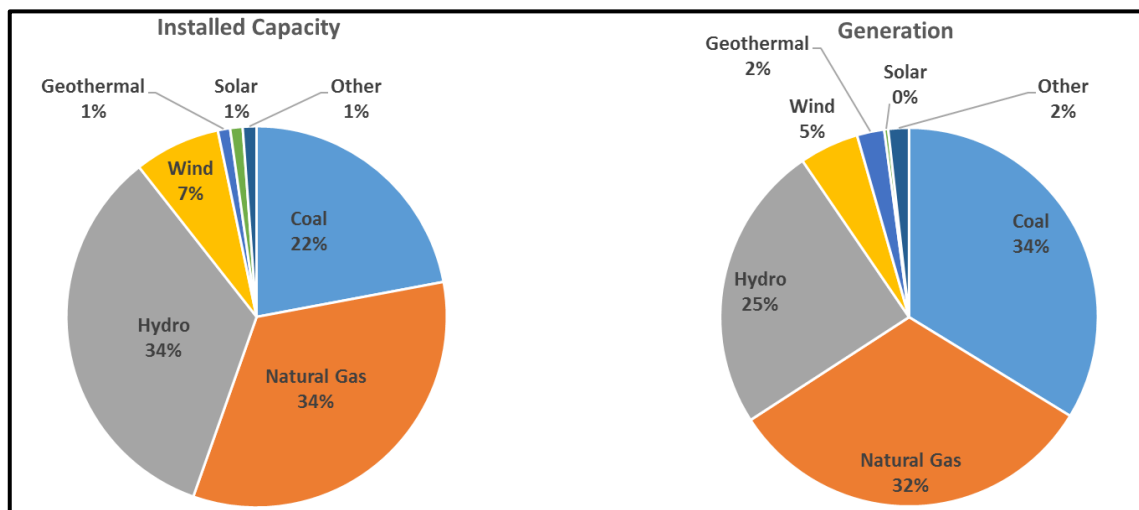

Figure 1.3 Installed capacity and electricity generation by fuel type in 2016 [2].

1.3 Water Consumption in Turkey

Multiple water resources can be found in Turkey, which includes rivers, lakes, and ground water. In 2008, the water potential has been calculated as 112 billion m³ and the available water per capita is 1,600 m³. [3]. According to the Turkish Statistical Institute, the water consumption for the industry and the domestic uses were 2349 million m³ and 3395 million m³ in 2014, respectively [4]. The annual industrial and domestic water consumption in Turkey between 2004 and 2014 are presented in Figure 1.4. As it can be seen from the figure, there is an increasing trend for both types of water consumption over the years. The domestic and industrial water consumptions in 2014 are nearly double the consumptions in 2004.

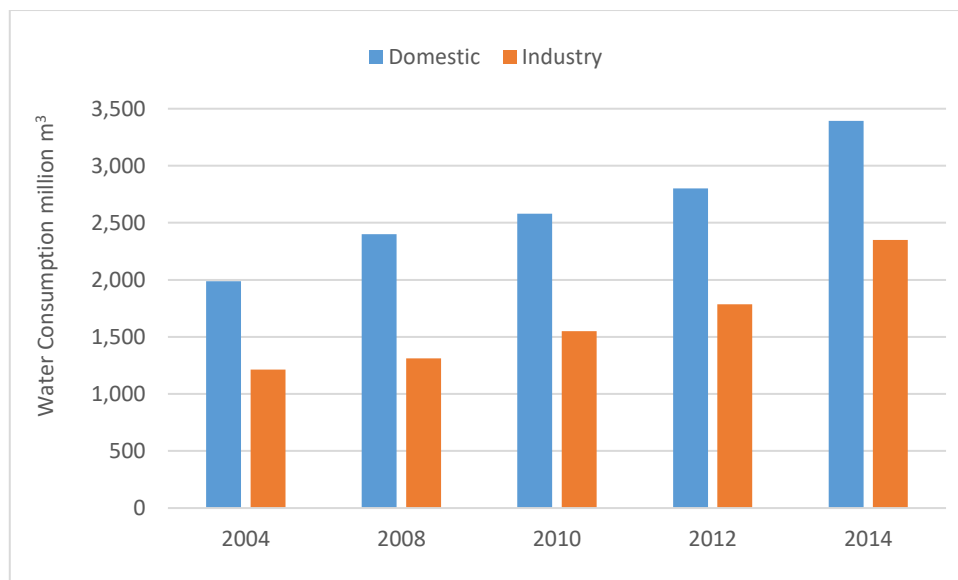

Figure 1.4 Annual industrial and domestic water consumption between 2004 and 2014 [4]

1.4 Problem Definition

In the locations like Turkey where water resources are limited, the water deficiency can be a problem restricting the electricity generation at location where there is water scarcity. Hence, it is important to investigate the total amount of water used per generated electricity and also to specify the water consumption of the various processes during electricity generation at power plants. Since the most water consumption at the power plants occurs at the cooling systems, it is important to

focus on analyzing the water consumption at various types of cooling systems and conduct the effects of substituting of these cooling systems by less water consuming ones.

1.5 Objective of the Thesis

The electricity demand of Turkey is increasing rapidly. More thermal power plants are expected to be built in the near future to supply the rapidly increasing demand. Hence, more water is required for the operation of these power plants. As the water reserves of Turkey is limited, it is important to find out the effect of the power plants on the water scarcity.

This study covers two main objectives; one is to identify the amount of water consumed (m^3) to generate 1 GWh of electricity based on each fuel type currently used in Turkey, and the other one is to investigate ways to reduce the water consumption per electricity generation at power plants expected to be built in the near future to supply the increasing demand.

1.6 Scope of the Thesis

This study is based on the fact that the cooling systems are the main water consumers during electricity generation at power plants. The detailed data on power plants is collected from the Turkish Electricity Transmission Corporation [TEIAS] [5] and a website titled as Energy Atlas [6]. The renewable energy potential data and the electricity demand forecasts are gathered from *the Blue Book* published by Ministry of Energy [7]. The cooling system types for power plants are collected from various sources [8] [9] [10]. However, the cooling system types for all the power plants was not available. Thus, the assumptions from the previous studies [11] [12] [13] for the cooling system types are made. The water consumption data of power plants is not available to the public access. Therefore, the water consumption factors (WCF) based on various technology and/or fuel types are collected from open literature [14] [15]. The water consumption due to evaporation at hydropower plants

is not considered in this study due to the difficulty of obtaining required data for calculations.

In this thesis, Long Range Energy Alternatives Planning (LEAP) software is used [16] in the development of the model and applying the scenarios. LEAP is preferred because it supports various electricity generation based on fuel types and facilitates the tracking of the energy generation based on the available resources and demand estimates. One of LEAP limitations is that there is no factor that takes into account the water consumption at power plants. This limitation is solved by replacing the variable cost (VC) variable used in the optimization process by the WCF.

1.7 Structure of the Thesis

This study consists of seven chapters. After presenting introductory information about the study in Chapter 1, a general background information about the relationship between the water and energy is presented in Chapter 2. Chapter 3 provides general information about the thermoelectric power plants and the water consumption at these plants and the common types of cooling systems used at these plants. Chapter 4 discusses the studies on determining the WCF, water consumption intensity (WCI, m^3/MWh) based on total electricity generation, long term forecasting of the water consumption from electricity sector and simulation programs used for electricity generation mixture optimization are summarized. Chapter 5 includes the methodology that is used in water consumption calculations and the application of scenarios to the model. Chapter 6 presents the results and discussions are provided. The study is concluded with Chapter 7 which presents the overall results and recommendations for future studies.

2 WATER AND ENERGY NEXUS

Water-Energy Nexus is the relationship between water and energy. A schematic of this relationship is given in Figure 2.1. In this chapter, a general background information about the relationship between the water and energy is presented. The first section of the chapter includes various processes involving the energy usage for water. The second section introduces the water consumption at the different stages of energy life cycle.

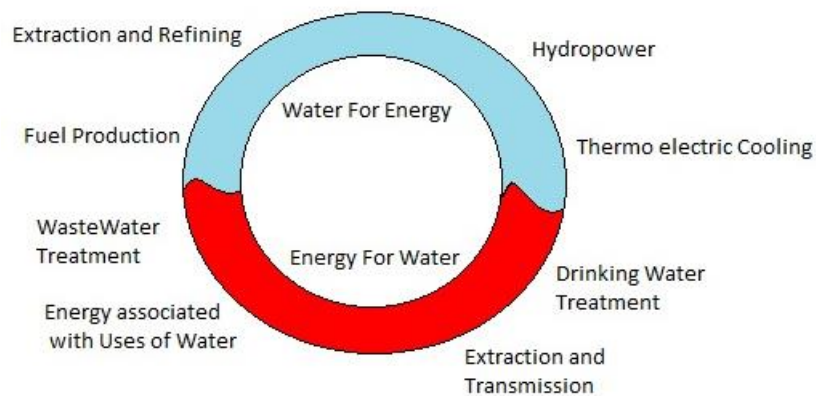

Figure 2.1 Water-energy nexus

2.1 Energy for Water

All processes in water life cycle from extraction to the end use phase cannot operate without the consumption of energy. These processes are depicted in Figure 2.2, and can be divided into the following parts.

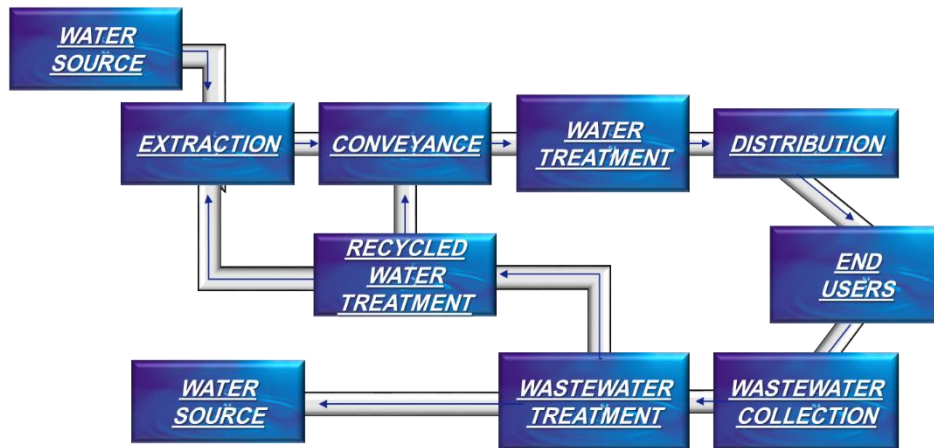

Figure 2.2 Energy demand of water systems [17]

2.1.1 Water Services

Processes like water conveying and supplying are the most energy intensive ones in the water life cycle. The pumps and other electric equipment consume energy to transport and pump the water from underground to the surface of the earth. Furthermore, wastewater treatment plants, water collection and distribution systems, and water treatment plants consume high amounts of energy processes like pumping and solid separation (sludge dewatering) processes. The amount of energy required for the water treatment processes depends on the water input quality. Moreover, to meet the increasing water demand, the use of desalination of brackish water, treatment of surface, ground or sea water is increasing. The desalination methods involve the use of membranes such as reverse osmosis, nano-filtration, or electro-dialysis; and others involve thermal methods. The membrane methods require energy for the separation process, whereas thermal methods consume energy for the evaporation and condensing processes [18].

2.1.2 Water End Use

More water is used at the end-uses than those at the water and wastewater treatment and supply processes. The water end use processes include hot water use, cloth washing, dish washing, cooking, and other processing at homes, commercial units, and industry. These end uses require energy for distribution, heating, and cooling of water [18].

2.2 Water for Energy

In the life cycle of the energy, water is considered as an essential component. Vast amounts of water are used for fuel production, fuel processing, and cooling technologies in large power plants [18].

2.2.1 Fuel Production

In the fuel production process, the water is consumed for mining, refining, drilling, washing of the fuel, and also land reclamation and revegetation after the extraction process [19]. The amount of water use depends on the type of the fuel and the extraction processes as explained below.

– Coal Production

Water is used for cutting and refining processes, and washing the coal. Water is also used to transport large volumes of coal for long distances at slurry pipelines in which a mixture of coal and water flows [20].

– Natural Gas and Shale Gas Production

Natural gas production processes require water for drilling, refining, and other processes. The amount of the water used depends on the geological formation of the drilling area, technological, operational, and regulatory processes. In the drilling phase negligible amount of water is consumed in conventional natural gas wells, however, a vast amount of water is used in the formation of the shale gas wells by hydraulic fracturing [19].

– Oil Production

Water consumption at the oil production depends on the geography and geology of the drilling area and recovery methods. At the first stages of the drilling process, almost no water is needed. However, the major use of water during oil

extraction occurs at the enhanced oil recovery process, in which the water is injected into the oil field to increase the flow of oil to the surface [19].

– **Uranium Production**

Water is used for dust control, ore beneficiation, and revegetation in uranium mining process [19].

– **Biofuel Production**

A Large amount of water is required for the irrigation and growing of the crops of the biofuels which can be then used to generate electricity or used for transportation fuel [18].

2.2.2 Water Used for Fuel Processing

Water is also used for processing the fuels to make the fuel ready to be used in power plants. Similarly, the amount of water used in these processes depends on the fuel type as presented below:

– **Coal Processing**

After being mined and crushed, the coal is washed to increase its the heating value and remove the impurities [19].

– **Natural Gas Processing**

Water is consumed for gas refining and other natural gas processing units [19].

– **Oil Processing**

Refining, sanitary services, fire protection and other purposes use small quantities of water at oil processing units. The major use of water occurs at the cooling system of the oil refining plants [21].

– **Uranium Processing**

Water is used at uranium processing in the formation of a slurry when crushed ore is mixed with water [22].

– **Biofuel Processing**

Water is needed in the process of extracting ethanol from corn, sugar cane, or similar products. Other water usages occur at the grinding, liquefaction, fermentation, separation and drying processes [19].

2.2.3 Water Used for Electricity Generation

Since the water is one of the major requirement in the electricity generation processes, it is important to clarify the water withdrawal and water consumption terms. Water consumption is the amount of water used that is no longer available because it has evaporated or removed from the original environment. While the water withdrawal is the amount of water which is taken from a source and returned to its original source [15].

The amount of water consumption depends on the electricity generation technology which can be categorized by fuel type. Detailed information on the use of water at renewable energy, nuclear energy, and fossil fueled power plants is provided in Chapter 3.

2.3 Closing Remarks

In this chapter, the relationship between water and energy is explained. Also, a general background about the water sector energy use is presented. In the last section of this chapter, information on the water requirement in the fuel production, fuel processing, and electricity generation are introduced.

3 WATER CONSUMPTION AT THERMOELECTRIC POWER PLANTS

The global demand for electricity, and hence electricity generation, is continuously increasing, and this results in an increase in the amount of water consumed in this sector. The amount of water consumption depends on the technology used for electricity generation. Majority of the global electricity is generated at thermoelectric power plants which use a significant amount of water especially at the cooling systems.

These types of electricity generation power plants mainly run by Rankine Cycle or Brayton Cycle. In both cycles, the turbines are used to generate mechanical energy from the flow of high temperature and pressure steam or combustion products depending on the cycle. In Rankine Cycle as depicted in Figure 3.1, the fuel is combusted with air and the heat released due to combustion is used to convert the water into steam at the boiler, then this steam is used to power the turbine.

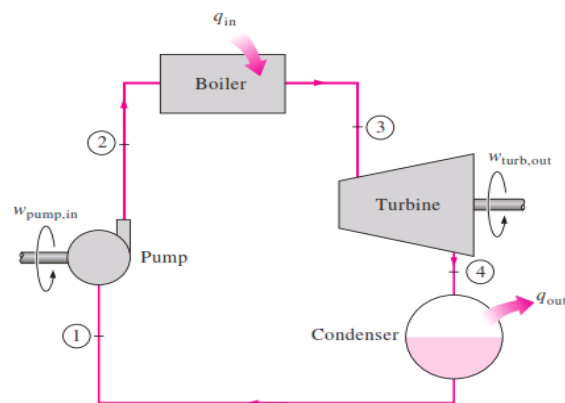

Figure 3.1 Rankine cycle [23]

Brayton Cycle is an open cycle where fuel is mixed with compressed air in the combustion chamber as presented in Figure 3.2. The combustion gases are then sent to the turbine for power generation. Furthermore, these two mentioned types of cycles can work together as a combined cycle system [24].

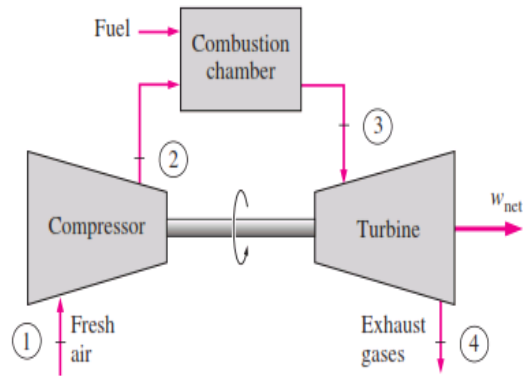

Figure 3.2 Brayton cycle [23]

The thermoelectric power plants can be categorized into renewable, nuclear, and fossil fueled power plants. In this chapter, general information about the thermoelectric power plants and the water consumption at these plants are presented. Then, common types of cooling systems used at these plants are introduced.

3.1 Renewable Energy Power Plants

Thermoelectric renewable power plants include the concentrated solar power (CSP), geothermal, and biomass power plants. In CSP plants, solar radiation is reflected to tubes passing through the panels. The fluid in the tubes is heated and used to boil the circulating water. The generated steam is then sent to the turbine (Rankine Cycle). The steam must be cooled and converted back to water after passing through the turbine. The CSP plants generally use wet cooling systems, which have the highest water consumption among the other systems and explained in detail in Section 3.4.2 [25].

Geothermal power plants also operate based on Rankine Cycle to generate electricity. Flash, binary cycle, and enhanced geothermal plants are the main and most widely used types. The flash geothermal power plant uses a steam/water reservoir. As the water flows up to the ground level, the steam separates from the water and moves the turbine to generate electricity. In the binary cycle systems, geothermal fluid is extracted from the reservoir and passed through a heat

exchanger to generate a steam from the water. After that, the generated steam is sent to the turbine for electricity generation. In enhanced geothermal systems, fractures are generated and water is injected into these fractures for steam generation. And then this steam is used to move the turbine for electricity generation [26].

The biomass power plants work based on Rankine Cycle or Brayton Cycle depending on the type of fuel used in the system. If the biomass is directly combusted, the plant works based on Rankine Cycle and the major water consumption occurs in the cooling system. If the biomass is converted to a mixture of combustible gases, the plant works based on Brayton Cycle [19].

3.2 Nuclear Power Plants

Boiling water reactors (BWRs) and pressurized water reactors (PWRs) are two main types of nuclear power plants and they both operate based on Rankine Cycle. BWR boils the water inside the reactor itself, and then the steam moves the steam turbine to generate electricity. PWR includes pumps and pipes to recirculate and boil the water, and it exchanges the heat from the fuel core to the water to boil it without any contact with the working water and the fuel core. At the end of the process, like other thermoelectric power plants, water is condensed at the cooling systems of the plant [27].

3.3 Fossil Fueled Power Plants

Fossil fueled power plants convert the chemical energy of fossil fuel such as coal, natural gas, and oil to heat by combustion process [28]. At the Rankine Cycle based power plants, this heat is used to convert the working fluid (mostly water) to steam at the boiler. This generated steam then moves the turbine blades. At Brayton Cycle based power plants, the combustion gases are directly sent to the turbine. After the steam expands in the turbine at Rankine Cycles, it must be converted back to the liquid phase which is conducted by rejecting heat to the environment. This process occurs by passing the working fluid, water in the form of saturated vapor, through a

heat exchanger where another stream at a colder temperature passes through the heat exchanger. The saturated vapor is converted to saturated liquid by rejecting heat while the temperature of the other stream increases. This heat exchange process occurs at the cooling system of the power plants which are based on Rankine Cycle [29]. Detailed information on cooling systems is provided in Section 3.4.

As mentioned before, the water is mainly consumed at the cooling systems of the power plants. The water is also used in the air pollution control systems since the power plants can emit large quantities of air pollutants such as sulfur oxides, nitrogen oxides, particulate matter, and incomplete combustion products. Sulfur oxides can be controlled by coal washing before the combustion and using wet scrubbers after the combustion which consume water. Nitrogen oxide emissions are controlled by steam injection during combustion to lower the combustion temperature. After the combustion process, the nitrogen oxides can be controlled using the selective catalytic reduction and selective non catalytic reduction. These control processes are used to reduce the nitrogen oxides to water vapor and nitrogen. Moreover, the water can be used for cleaning and maintenance of these processes [30].

3.4 Cooling Systems of Rankine Cycle

The heat rejection at a power plant running on Rankine Cycle occurs in the cooling systems of the plant. The commonly used cooling systems are once through, wet tower, and dry cooling systems [1]. One through cooling systems and wet towers are mostly preferred at large power plants, while dry cooling systems are used at smaller power plants. The approach that can be used in choosing the most appropriate cooling systems for power plants based on the capacity of the plant and temperature difference is presented at EU's Best Available Technique Reference Document, as can be seen in Table 3.1 [11].

Table 3.1 Thermodynamic characteristics and thermal capacities of different cooling systems in the power industry [11]

Cooling System	Applied Cooling Temperatures (°C)	Thermal Heat Input (MW _{th})
once-through systems	13-20 (terminal difference 3-5)	< 2700
wet cooling tower	7-15	< 2700
hybrid cooling tower	15-20	< 2500
Dry air cooled condenser	15-25	< 900

Similarly, the choice of cooling system used for geothermal power plants also depends on generation capacity of the plant [12]. The commonly used cooling system for biomass power generation is the wet cooling towers [13].

The heat load which is rejected in the cooling system consists of sensible and latent heat. The direct heat rejecting to the environment is the sensible heat, whereas the latent heat transfer occurs due to evaporation of water. The waste heat rejected through latent heat transfer must equal the latent heat in the water evaporated (*i.e.* consumed) by the cooling system.

$$\dot{W}_{evap} = \frac{\dot{Q}_{load} \times k_{lat}}{h_{fg}} \quad (3.1)$$

where \dot{Q}_{load} is the amount of heat rejected [MJ/s], \dot{W}_{evap} is the rate of water consumption [kg/s], h_{fg} is the latent heat of vaporization of water [MJ/kg], and k_{lat} is the fraction of latent heat rejected. As h_{fg} is a constant at a given temperature and pressure, the evaporation rate of water \dot{W}_{evap} is directly proportional to k_{lat} at a given heat load. As the k_{lat} increases, more water is consumed per unit of heat rejected [31]. In the following sections, the mass and heat balances for each cooling system are explained in detail.

3.4.1 Once Through Cooling System (OTCS)

In the past, OTCS used to be the commonly used cooling systems at the power plants. This system withdraws a large amount of water from a nearby water body such as ocean, river, lake, pond or canal as shown in Figure 3.3. The system has adverse environmental effects on the aquatic life due to increasing the water temperature. However, this system is preferred mostly due to its low capital cost, operating cost, and low water consumption. The water consumption results due to the evaporation of the effluent water [1] [32] [19].

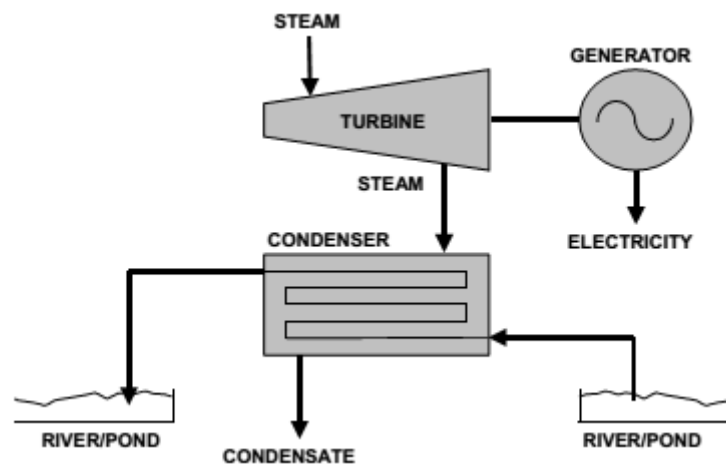

Figure 3.3 Once through cooling system [1]

The value for k_{lat} can be determined using the below equation for once through systems [31].

$$k_{lat} = \left(1 + \frac{\gamma}{\beta} + \frac{4\epsilon\sigma T_s^3}{h_{fg}f_v\beta}\right) \quad (3.2)$$

where f_v is the wind speed function [kg/s-m²-Pa] which is a mass transfer coefficient that is correlated with wind speed v [m/s], T_s is the surface temperature [K], γ is the psychrometric constant [Pa/K], which changes slightly depending on atmospheric pressure, ϵ is the emissivity of the water surface and assumed as 0.9, and σ is the Stefan-Boltzmann constant which is 5.67×10^{-14} MJ/m²-s-K⁴, β is the thermodynamically constant function [Pa/K]. Detailed information on these

parameters can be found at [31]. Once k_{lat} is determined, \dot{W}_{evap} can be determined using Equ. 3.1.

3.4.2 Wet Tower Cooling System (WTCS)

The WTCS are closed cycle systems using a recirculating loop. After condensing the steam at the heat exchanger, the water is pumped again to the evaporative cooling tower as presented in Figure 3.4 . The water is cooled by evaporating some of the recirculated water. Even though this system does not withdraw large amounts of water, but it consumes more water than the once through system during the evaporation process. In addition, the cooling towers are costly and complex, but they are effective for heat rejection in both warm and cold environments [1] [31].

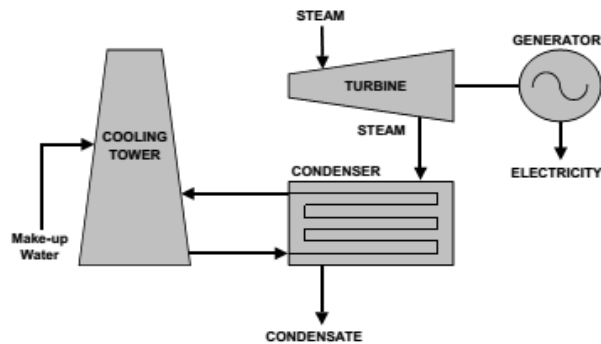

Figure 3.4 Closed Cycle Cooling System [11]

In these systems, the water which is used in the cooling tower to control the buildup of the dissolved and suspended material through the evaporation cycle is called the blowdown water. Due to the high temperature of the blowdown water, it can be evaporated. The drift water in the cooling system is the water droplets that is discharged to the environment with the exit plume. The value for k_{lat} is taken as a constant between 0.84 and 0.90 [31]. Once k_{lat} is determined, \dot{W}_{evap} can be determined using Equ. 3.1.

3.4.3 Dry Cooling System

The dry cooling system uses air to reject the heat from the steam. In another word, it eliminates the water consumption in the cooling process. The dry cooling system can be categorized as direct and indirect systems. In the direct system which is also called the air cooled condenser, air flows directly across the steam in a tube array as presented in Figure 3.5. In indirect systems, an intermediate medium which is a water condenser is used. Then, the heat from the water is rejected to the atmosphere by a tube array as can be seen in Figure 3.6 [33].

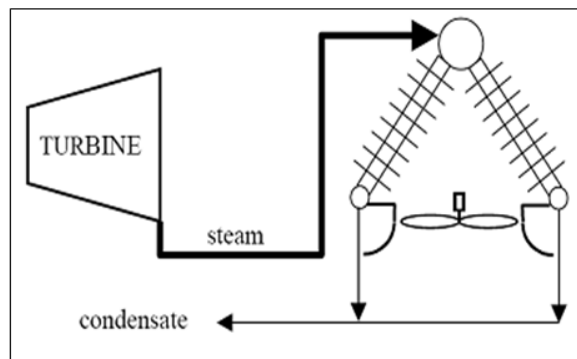

Figure 3.5 Schematic of direct dry cooling system [31]

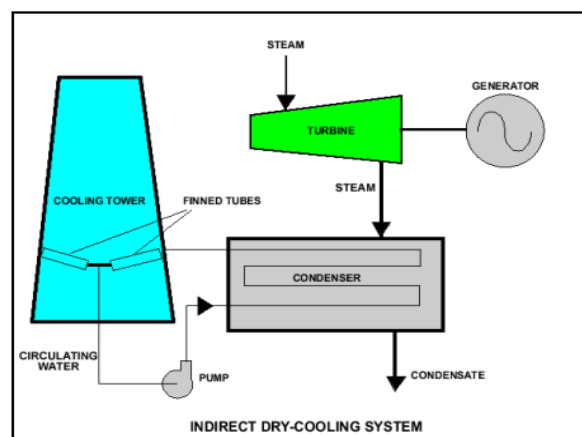

Figure 3.6 indirect dry cooling system [12]

A form of indirect dry cooling systems is called the Heller system which contains two steps as can be presented in Figure 3.7. In the first step, the steam is condensed directly using a working fluid. Then in the second one, the working fluid is cooled in the heat exchanger using the air. This system increases the efficiency of the system in the higher temperatures without consuming further amounts of water [12].

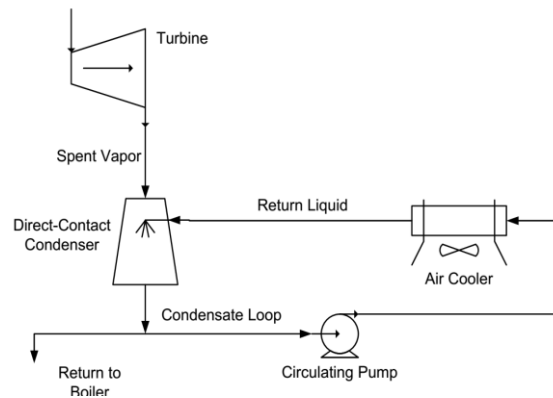

Figure 3.7 Schematic of the Heller system [12]

The heat rejection efficiency of the dry cooling system is lower than the other cooling systems since the heat capacity of the air is less than the water, so the steam temperature after being cooled is always higher [34]. The efficiency of these systems also goes down in hot days in which the demand for electricity increase. Thus, the cooling system efficiency affects the total power plant efficiency. In addition, the dry system has high capital and operation costs, large site space requirements and limitations in the hot days [35]. The dry cooling system consumes a negligible amount of water.

3.5 Closing Remarks

In this chapter, information about the cooling systems is given. Furthermore, the analysis of the heat and mass balance for each type is introduced. This brief information on cooling systems shows that cooling systems can be ranked based on water consumption as wet cooling towers, once through, and dry cooling system.

4 PREVIOUS STUDIES

Water consumption and water withdrawal data of operating power plants are readily available at some countries. For example, US Geological Survey (USGS) and US Department of Energy Information Administration (EIA) provide annual water usage at power plants [36]. In some studies, these available data are used to determine the water consumption factors (WCF, m^3/GWh) for various types of cooling systems of electricity generating technologies. These factors present the amount of water consumed per unit of electricity generated [31]. Where these data are not available, models are developed using the limited available data to estimate the water usage at power plants based on cooling systems of various generating technologies. The first part of this chapter summarizes the studies on determining the WCF from available field data or developed models, and water consumption intensity (WCI, m^3/MWh) based on total electricity generation. The second part of the chapter reviews the studies on long term forecasting of the water consumption from the electricity sector. The third part of this chapter provides brief information on the studies about simulation programs used for electricity generation mixture optimization for long term forecast. This optimization approach is used to determine WI's based on various generation mixtures. The last section of the chapter summarizes studies on determining ways to reduce water consumption at power plants.

4.1 Studies on Determining Water Consumption Factors

Water consumption factor (WCF) based on the cooling systems of various electricity generating technologies is an important factor in determining the water consumption at power plants. The studies about the water needs in the cooling systems are limited because the detailed data are not available. The WCFs for power plants can be calculated using the field data or models.

The integrated management of the water and energy is an old topic. In 1994 Gleick [37] analyzed the inter-relationship between the water and energy by employing the electricity generation life cycle analysis for U.S power plants using field data. The author quantified the WCFs for the energy life cycle. Another study in 2002 by Electric Power Research Institute (EPRI) was conducted to estimate` the water

consumption and withdrawal at the thermal power plants in the US [38] using field data.

The United States Department of National Energy Technology Laboratory (NETL) has published three reports about the water usage and losses at the fossil fueled power plants in 2005 [39], 2007 [40] and 2009 [41]. They estimated the water consumption based on the overall water balance of each cooling system. Then, they calculated the WCFs by dividing the water consumption by the electricity generation (m^3/GWh).

In 2005, Vassolo *et al.* [42] estimated the water consumption at thermoelectric power plants for a grid cell which included 50 states from the US and 89 regions from Russia. They did the estimation based on the geographical location for 63590 thermal power plants. The WCFs for these power plants were calculated from the estimated water consumption. After that, based on these WCFs, the water consumptions for all the power plants in the grid cell were calculated. In the same manner, Jacobson [43] estimated the water consumption at the CSP wet tower cooled power plants.

In 2006, U.S. Department of Energy (DOE) prepared a report presenting a background information about the water and energy interaction [14]. The report estimated the WCFs for the thermoelectric power plants using field data. Moreover, the US Energy Information Administration (EIA) conducted 923 surveys [44] to collect information about the operation of the electric power plants. This information included the operational cooling water consumption data.

In 2010, Fthenakis and his colleagues [45] examined the water consumption at the US power plants. The WCF's for the conventional and renewable power plants in the electricity generation phase is determined using field data [37]. The results of the study showed that the wet cooling towers are the highest water consumer technology among all of the cooling systems. The once through and dry cooling systems are suggested to reduce the water consumption at the power plants by the authors. On the other hand, the PV and wind turbines consume the lowest amount of water, especially at the operation phase.

Macknick *et al.* [15] analyzed the water consumption at various US power plants in 2011. They took into account the water consumption in the operational phase only.

The results of their study showed that thermal power plants with wet cooling tower systems consume more water per unit of generated electricity than the once through cooling systems. Furthermore, based on this study, the coal and lignite power plants consume the highest amount of water among all types of plants; consequently, PV and wind as renewable power plants, and CSP, Stirling Engine technology, and natural gas combined cycle power plants with dry cooling systems have lower WCF. In a similar way, in 2014 Killy [46] and in 2013 Meldrum [47] performed compilations of the water consumption and withdrawal factors from Macknick study [15]. They identified the water consumption depending on the changes in the fuel type and cooling technology type.

Karakas *et al.* [48] investigated the effects of the water resources limitation on the electricity generation sector in Turkey. The authors integrated an optimization model to evaluate the relationship between the water consumption and the electricity demand. This study used the water consumption and withdrawal factors which are taken directly from Macknick's study conducted in the US [15]. This study focused on the water withdrawal instead of water consumption at the power plants. The author applied three scenarios based on changing the current cooling systems. The results showed that the pond cooling system withdraws 64% less water than the once through one. Also, the wet cooling towers save 98% of the withdrawn water compared to the once through cooling system. The study recommends retiring the old power plants with once through cooling systems, to decrease the water withdrawal in Turkey.

In 2013, Jiang *et al.* collected water consumption data of 19 coal power plants in Shandong, China [49]. Then, the power plants were categorized based on their installed capacities and boiler types (subcritical, supercritical and ultra-supercritical). According to the results, the wet cooling towers are the most common type in Shandong. The authors also stated that the WCF vary seasonally, where for example the WCF in July are 15-28% higher than the ones in January.

In 2014, Peer *et al.* [50] grouped the water consumption of 672 U.S. power plants based on the fuel, prime mover (combined cycle or steam) and cooling system. Then, the operational water use rates were calculated using EIA [44] cooling water data. The study results presented that the wet cooling towers are the highest water consumer technology and the once through is the highest water withdrawer among

all of the cooling systems. Also, it was stated that the calculated median for the water consumption and withdrawal are similar to the ones determined by Macknick [15].

Many studies did not just collect the data, they also integrated some models for estimating the water consumption at the power plants. One of them was Rutberg and his team [31] in which they integrated a level generic model called SGEM. The main purpose of the model was to estimate the water usage at wet tower cooled power plants and to calculate the water consumption and withdrawal. Using this model, the levers that control power plant's water use can be determined. The data from the literature and from the field are used to validate the SGEM model. The evaluation results showed that the SGEM model is accurate for wet tower cooled power plants.

Delgado *et al.* [30] also developed a simple model to determine the water consumption of the power plants. The model is based on analyzing the water and heat flows in the power plants. Using the Eskom pulverized coal power plant data in South Africa, the model results showed a good match with the field data. The model can accurately estimate the water usage at the thermal power plants. Furthermore, it is helpful to know how to reduce the water consumption at the power plants.

In another study, Dale *et al.* [51] developed a model using two popular simulation tools (LEAP and WEAP) to define the impact of the climate change on the regional water and energy systems. In this study, data from some power plants in California is used to check the vulnerability of energy and water planning systems.

Strzepek *et al.* [52] developed a model called "Withdrawal and Consumption for Thermo-Electric System". This model uses a WCF to estimate the water withdrawal and consumption for any electricity generation portfolio. The data in this study is obtained from USGS and NETL reports [39] [40] [41]. To show the capabilities of the model, the impacts of the high sharing of the renewable energy resources on the water consumption was examined in the United States. The results showed the high reduction in the water consumption by using the renewable energy sets.

The WCFs determined in the studies summarized above are presented in the following table.

Table 4.1 The water consumption factors (WCF) from the earlier studies (m³/GWh)

Tech.	Gleick [37]	EPR I [38]	NETL [39]	V&D [42]	DOE [14]	NETL [40]	Jacobson [43]	Jiang [49]	Scanlon [53]	Davies [54]	NETL [41]	EIA [44]			Macknick et al. [15]		
												Min	Med	Max	Min	Med.	Max
Coal																	
Once-thru	1200	1100		650	1100				1968	950	500	0.38	772	3846	378	946	1199
Wet tower	2600	1800	3900-4400	1330	1100-1800	2200-2600		2625	2120	2600	1800-2000	750	1529	7098	1817	2600	4163
Dry Pond															106	106	106
wet with CCS		1800		1330	1800					53200	200-3000				1135	2036	2649
						4400-5000				3570	3200-3700				3600	3600	3600
Oil/NG																	
Once-thru	1100	1100		650	1100					910	300	1382	1787	2192	400	900	1100
Wet tower	2600	1800		1330	1100-1800					3130	600	242	3153	8438	2500	3100	4400
Pond		1800		1330	1800					3130	400				2500	3100	4400
Nuclear																	
Once-thru		1500		650	1100				1741	1020		572	572	572	378	1018	1514
Wet tower	2200-3200	2700		1330	1500-2700					2540	2400	1987	2544	3305	2199	2543	3198
Pond		2700		1330	2700					2310					2119	2309	2725
NGCC																	
Once-thru		400		650	400				454	380	80	9.08	712	1412	75.7	378	4000
Wet tower		700	1900	1330	700	1000			871	750	500	825	825	825	492	749	1135

Tech.	Gleick [37]	EPR I [38]	NETL [39]	V&D [42]	DOE [14]	NETL [40]	Jacobson [43]	Jiang [49]	Scanlon [53]	Davies [54]	NETL [41]	EIA [44]			Macknick et al. [15]		
												Min	Med	Max	Min	Med.	Max
Dry															7.5	7.5	7.5
Pond wet with CCS		700		1330						910	900				908	908	908
						1900				1430					1400	1400	1400
IGCC																	
Wet tower wet with CCS					800	1400				130					1200	1400	1700
						1800 - 2000				2040					2000	2000	2100
Geothermal																	
Flash Tower															18.9	37.8	71.9
Flash dry	0														0	0	0
Binary Tower					5299					6820					5000	5299	15000
Binary dry										670					0	511	1022
EGS dry															1135	3217	6730
Binary hybrid															300	800	1400
CSP(solar)																	
Tower Dry	4000				2800		2800			3350							
										300					162	295	299
Biogas																	
Tower Once-thru															889	889	889
															1135	1135	1135

Tech.	Gleick [37]	EPR I [38]	NETL [39]	V& D [42]	DOE [14]	NET L [40]	Jacobso n [43]	Jian g [49]	Scanlo n [53]	Davie s [54]	NETL [41]	EIA [44]			Macknick et al. [15]		
												Min	Med	Max	Min	Med.	Max
Pond															147	1135	1817
Dry															132	132	132
PV	0							0		20					0	98	124
Wind	0							0		0					0	0	0
Hydro										17000					539	1700	6800
															4	0	0

4.2 Studies on Forecasting the Water Consumption and Intensity

There are many studies on forecasting the future water demand for the electricity generation which are different in the temporal and spatial boundaries, methodology and scenarios. In one of these studies, Feeley [29] examined the effects of different cooling systems with various technologies on the water consumption at various US power plants in 2008. The authors forecasted a 25-year water use of the thermoelectric power plants. The water consumption is calculated using the WCF which were determined by the EIA [44]. The results of the study showed that the power plants with wet cooling tower consume five times more water per generated electricity than once through cooling systems. Moreover, the power plants which are based on Rankine Cycle like nuclear and coal power plants consume more water than the ones which are based on Brayton Cycle.

Murrant *et al.* [55] modeled the water demand for the UK electricity sector from 2010 to 2030 using the “Energy System Modelling Environment” model. This study used WCFs specific to UK, which were calculated previously by Infrastructure Transitions Research Consortium [56]. The results showed that with the increase of the electricity demand, the water consumption intensities would decrease from 549 m³/GWh in 2010 to 369 m³/GWh in 2030. The reduction in the water consumption intensities has resulted from the increasing share of the renewable energy resources over the study period.

Liao *et al.* [57] quantified the water use of China’s thermoelectric power plants from 2014 to 2050. The data of the study was collected from the World Electric Power Plants Database [58]. The authors used a bottom- up approach to forecast water use. The results concluded that the water consumption intensity would increase from 932 m³/GWh in 2014 to 1500 m³/GWh in 2050. This increase is due to the use of the wet cooling towers in the country, which causes the high water consumption. The authors recommended to increase the renewable energy share to reduce the water consumption intensities.

Davies *et al.* [54] investigated power plants water use in 14 world regions (USA, Canada, Western Europe, Japan, Australia, Former Soviet Union, China, Middle East, Africa, Latin America, Southeast Asia, Eastern Europe, Korea, and India) from 2005 to 2095. The WCF data were taken directly from the US study [15]. This study

focused on the change of the electricity technology share, changes in the cooling systems and water saving technologies. The electricity generation technology mixture is determined using the Global Change Assessment Model (GCAM) which is an integrated assessment model of energy, agriculture, and climate change. The results showed that the global electricity generation demand would increase 80% from 2005 to 2095. Also, the water consumption would increase by 70% on the same period. This study yielded that the water consumption would increase over the years due to the increasing of thermoelectric power plants and the change from the once through cooling system to the evaporative cooling towers.

Kyle [59], Dooley [60], and Talati [61] investigated the influence of the climate change on the global water consumption based on the electricity generation. The WCFs in these studies were obtained from Davies's study [54]. The WCFs are incorporated into a model of energy, agriculture, and climate (GCAM), as well. Various scenarios based on different climate change policies were applied. The results of the studies showed that the water consumption intensities from 2005 to 2095 would increase due to the retirement of the once through cooled power plants and the usage of the wet cooling towers. Kyle [59] specified that the global water consumption would increase 60% over the study period. The results of the study conducted by Talati [61] presented a 12% increase in the water consumptions and he advised to increase the sharing of the dry cooling system and increase the dependence on the solar and wind power plants to reduce the water consumption.

In another study, water consumption and withdrawal data of power plants located in Texas, US, are collected from various resources. The water consumption and withdrawal intensities are calculated by dividing the water consumption by the net electricity generation of each power plant type. The total water consumption intensity for the electricity generation in Texas in 2010 was determined as 0.395 m³/MWh. [53].

In this study, the water consumption and intensities for the Turkish power plants are estimated from 2016 to 2035. The estimations are determined using the WCF provided at Macknick [15]. The estimations are conducted for all the available electricity generation technologies in Turkey. Since it is estimated that the nuclear power plants are expected to start operating in 2022, they are taken in the consideration in the calculations.

4.3 Studies on Electricity Mixture Optimization

In order to calculate the future water consumption, the electricity supply and demand must be analyzed. Long Range Energy Alternative Planning (LEAP) is one of the software models that is used in many studies to estimate the future electricity generation supply and capacities. LEAP is mainly used in the forecasting of the GHG emissions and the energy demand. LEAP allows the users to apply different generation technologies using various scenarios [16]. It is used for diverse energy-environment- economy optimization purposes. Ghanadan [62] used LEAP to forecast the energy demand and identify the alternative fuels for California. In order to define the different scenarios for electricity generation, Islas used LEAP modeling in Mexico [63]. Furthermore, it was used to predict the energy demand and air pollution from the transportation section in Pakistan [64]. In Iran, Ataei used LEAP in his study to evaluate the energy consumption between 1980 and 2030 [65]. Dagher *et al.* [66] modeled the future electricity paths for Lebanon from 2006 to 2050. They used LEAP to conduct different electricity generation scenarios and technical and environment implications.

Viola *et al.* [67] integrated a smart grid to develop the electricity sector of Colombia. This analysis was conducted using LEAP software from 2012 to 2050. Moreover, LEAP was used for the energy forecasting in Bangladesh. As a first application, Khan *et al.* [68] forecasted the natural gas consumption for different sectors from 2007 up to 2020 using LEAP. LEAP was used by Hasret [69] to analyze the decarbonization of the public electricity sector in Turkey from 2001 to 2050.

In this study, the electricity generation mixture optimization for Turkey is applied using LEAP, and various cooling systems scenarios are applied to the model development at LEAP.

4.4 Studies on Water Consumption Reduction

The water usage and conservation at the power plants has been an important issue mainly due to the lack of water resources. Since the majority of the water consumption in the power plants occur at the cooling systems, many studies have been focusing on the cooling system alternatives which use less water than

conventional ones. In the U.S., many studies are conducted to compare the alternative cooling systems at the electricity generation power plants. In one of these studies [35] the systems were compared based on various factors; such as the cost, the water consumption and the environmental impacts. The comparison led to the fact that the DCS reduces nearly 95% of the water consumption at the power plants. However, it shows that the dry cooling system is not efficient in the dry days and the capital cost is high.

For the same reason, Webber [70] integrated three water cooling system scenarios. The first scenario simulates the changing of the OTCS to WTCS. The second scenario implements the hybrid wet-dry cooling system. The last one represents the using of DCS. The scenarios were based on the water consumption factors which were taken from a previous study [37]. The results showed that the high reductions occur by DCS, but the efficiency is low due to the difference in the heat capacity of the air and water. However, the second scenario achieves the objective more reduction of the water consumption and keeps the system efficient.

In another study, Nouri [34] conducted an extensive study to analyze the water consumption at the power plants in California, US. Due to some limitations and constrains, a linear model was used to optimize the water usage at the power plants. The WCFs were taken from the US study [15]. Various scenarios, where no hydro and no nuclear power plants are included in the generation mixture are applied. The results showed that the generation mixture which includes wind, solar and fossil fueled power plants cooled by DCS resulted in low efficiency. Low efficiency means producing less electricity at the same amount of water consumption. So, hybrid cooling system is recommended by the authors, which use the wet component in the hot days and the dry component in the normal days to decrease the water consumption.

This study analyzes the reduction in water consumption when different cooling systems are used in the electricity generation. The analyses are conducted by applying various simulation scenarios.

4.5 Closing Remarks

In this chapter, the studies on determining the water consumption based on the electricity generation were summarized. Many studies have been conducted around the world on modeling the water consumption for the future electricity generation demand. The methodologies and the scopes which are used in the studies are different, especially as the countries and the time are different. It is noticed that the WCFs from [15] were used as essential factors in many recent studies in different areas of the world for determining the water consumption at the electricity generation.

In the scope of the studies examined, one study [48] was conducted in Turkey concerned about the water usage at the electricity generation power plants. The focus of that study is the water withdrawal and not the consumption, while this study focuses on the water consumption.

In this study, the WCFs from [15] are used to calculate the water consumptions and intensities at different generation technologies in Turkey. Then, the results are used to build the baseline of the model in LEAP. The LEAP is used to determine the electricity generation mixture optimization for the different scenarios from 2017 until 2035.

5 METHODOLOGY AND DATA SOURCES

This chapter presents the methodology of this study which is summarized in Figure 5.1. The study consists of multiple processes which can be divided into three main stages; data gathering and analysis, model development, and scenario applications. The following sections describe the three stages in details.

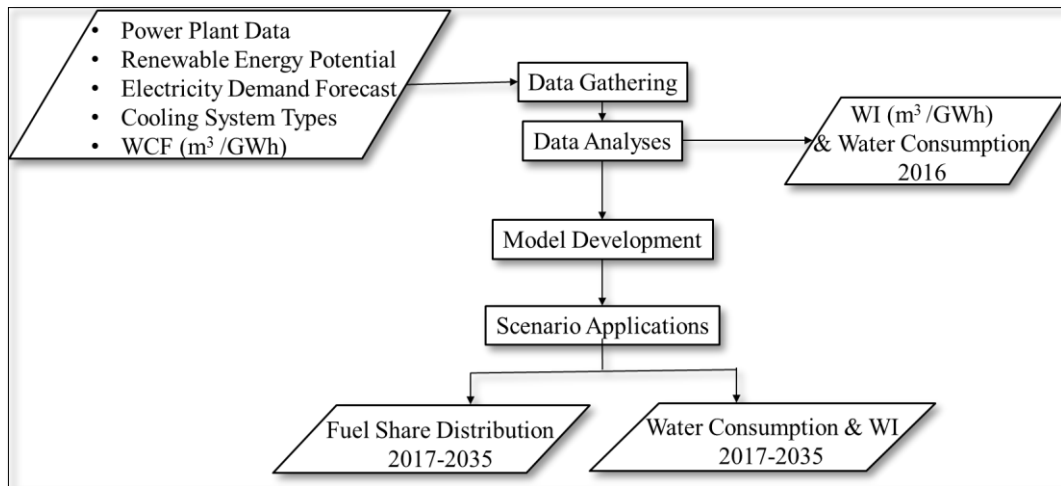

Figure 5.1 Methodology of the study

5.1 Data Gathering and Analysis

Under this stage, data on the power plants, renewable energy potential, electricity demand forecasts, cooling system type of all power plants operating in 2016 (where available) at Turkey (approximately 1581 power plants of which 361 are thermoelectric power plants) are gathered from various sources [5] [6]. The water consumption data of Turkish power plants are not available for public access. Thus, WCF (m³/GWh) for all power generation technologies currently operating in Turkey are gathered from several studies [8], [9], [10] as presented below.

5.1.1 Power Plant Data

The data on fuel and technology type, installed capacity and the electricity generation of the power plants are collected from two sources. To guarantee the consistency and correctness of the data, two sources are used which are:

1. Turkish Electricity Transmission Corporation [TEIAS] is one of the biggest electricity transmission companies. The data is provided at the company's website [5].
2. Energy Atlas is a website [6] with the most current and detailed data on the electricity sector in Turkey. The data presented here are assembled from several institutions such as Energy Market Regulatory Authority (EPDK), Turkish Statistical Institute (TURKSTAT), Turkey Electric Transmission Inc. (TEİAŞ), Electricity Generation Inc. (EÜAŞ), General Directorate of Renewable Energy (YEGM), and State Hydraulic Works (DSİ). The final data for this study is collected on January 1st, 2017 from this website.

After collecting and checking the data, the pulverized coal/lignite, combined cycle natural gas and binary geothermal was found to be the most common technologies used at power plants based on fuel types in Turkey. Based on these information, the above mentioned technologies are used as the main technology for each mentioned fuel type throughout this study. Also, it is observed that generation data of some power plants are missing. The capacity factors based on fuel type and installed capacity are used to determine the generation of these power plants. Capacity factors for each fuel type are determined using Equ. 5.1 utilizing the fact that the total installed capacity and the total generation for each fuel type for 2016 is provided in [6].

$$CF = \frac{GEN}{IC \times 24 \times 365} \quad (5.1)$$

where GEN is annual generation (MWh/year), CF is capacity factor [-], and IC is installed capacity (MW).

The capacity factors of the electricity generation technologies and generation shares for Turkey in 2016 are summarized in Table 5.1.

Table 5.1 Turkish power plants data in 2016

Fuel Type	Installed Capacity (MW)	Generation (MWh)	Generation Share (%)	Capacity Factor
Natural Gas	24,406	90,992,811	33.64%	0.43
Coal and Lignite	17,510	90,262,173	33.37%	0.59
Geothermal	775	4,213,526	1.56%	0.62
Solar Energy	626	612,338	0.23%	0.11
Wind Energy	5,404	15,369,548	5.68%	0.32
Hydropower	26,515	67,067,360	24.79%	0.29
Biogas	436	2,008,183	0.74%	0.53
Total	75,672	270,525,939	31%	-

By using these CF, the generation of the missing power plants is calculated by multiplying the IC with the CF. Data on nuclear power plants capacity and electricity generation are gathered from [6]. Two power plants are estimated to operate in the near future which are Akkuyu and Sinop power plants. The estimated time for the operation of the units of these power plants is presented in Table 5.2. The estimated generation of Sinop power plant is not provided. Thus, it is calculated based on Akkuyu installed capacity and generation by applying Equ 5.1.

Table 5.2 Annual operation increase of expected nuclear power plants [6]

Year	Akkuyu Power Plant (MW)	Sinop Power Plant (MW)
2022	1200	
2023	2400	1120
2024	3600	2240
2025	4800	2240
2026	4800	2240
2027	4800	3360
2028	4800	4480

5.1.2 Renewable Energy Potential Data

The potential for each type of the renewable resources in Turkey is presented in Table 5.3 [7].

Table 5.3 Potential of renewable energy resources in Turkey

Fuel type	Potential (GWh)
Hydropower	160,000
Solar	380,000
Geothermal	10,862
Wind	136,656
Biogas	232,600

5.1.3 Electricity Demand Forecast Data

The electricity demand estimations until 2035 were gathered from the *Blue Book of Turkey* which is published by the Ministry of Energy and Natural Resources [7]. The medium electricity demand estimates are used in this study as presented in Table 5.4.

Table 5.4 Electricity demand estimations (GWh) in Turkey [7]

Year	High	Medium	Low
2016	270,526	270,526	270,526
2017	320,470	301,160	293,150
2018	340,580	318,430	307,720
2019	361,810	336,730	322,620
2020	384,220	355,880	338,060
2021	404,920	374,570	352,950
2022	426,610	393,910	368,200
2023	449,320	413,980	383,940
2024	473,100	435,010	400,650
2025	498,010	456,880	417,960
2026	524,080	479,660	435,910
2027	551,370	503,390	454,510
2028	579,930	528,110	473,790
2029	609,810	553,850	493,780

Year	High	Medium	Low
2030	641,080	580,670	514,500
2031	669,110	606,740	534,980
2032	698,230	633,580	555,900
2033	728,480	661,280	577,450
2034	763,980	689,910	599,700
2035	802,180	719,540	622,680

5.1.4 Cooling System Types

Data on cooling system types of power plants are gathered from various sources [8], [9], [10]. Nevertheless, it was not possible to find any information about the cooling system types of some power plants currently running in 2016. To fill the gap, various studies are investigated. It was observed that the cooling system type depends on the thermal efficiency, electricity generation, and fuel type of the power plants. Employing this published information, the missing data are filled as presented below.

1. Coal and Natural Gas Fueled Power Plants:

The European Commission [11] provides the thermal characteristics and thermal heat input of different cooling systems of the fossil fueled powers as presented in Table 3.1. The cooling system type can be defined after calculating the capacities using the following equation.

$$IC = TE \times THI \quad (5.2)$$

where TE is the thermal efficiency and THI (MW_{th}) is the thermal heat input. The thermal efficiency is assumed 33% for the coal power plants and 55% for the natural gas power plants [71]. The calculated capacities are presented in Table 5.5.

Table 5.5 Cooling systems based on thermal heat input (MW_{th}), thermal efficiency, and installed capacity (MW)

Cooling System	Thermal Heat Input (MW_{th})	Thermal Efficiency		Installed Capacity (MW)	
		Coal	NG	Coal	NG
Once-Through Systems	< 2700	0.33	0.55	891	1485
Wet Cooling Tower	< 2700	0.33	0.55	891	1485
Hybrid Cooling Tower	< 2500	0.33	0.55	825	1375
Dry Air Cooled System	< 900	0.33	0.55	297	495

After obtaining the IC data of the power plants, the cooling systems of the missing power plants are determined using the information given in Table 5.5. As the OTCS and WCT have the same installed capacities, it is assumed that the half of the missing power plants is cooled by OTCS and the other half is cooled by the WCT.

2. Geothermal Power Plants:

NREL [12] provides the relationship between the cooling system types and the average annual electricity generation (MWh/yr). The missing cooling system data of the power plants are determined using the data provided in the study. The cooling system of the power plants with a generation lower than 85,450 MWh/year are taken as dry cooling system and the ones with a generation higher than 183,960 are taken as wet cooling towers.

3. Biomass power plants:

NREL [13] states that the common method of cooling is the wet cooling towers. Consequently, the wet cooling system is assumed for all biomass of power plants.

5.1.5 Water Consumption and Factors (WCF)

The information on water consumption at Turkish power plant is not available for public access. To determine the water consumption of these power plants, fuel type and cooling system based WCF are used. Various studies on determining WCF are examined as presented in Section 4.1. These factors are tabulated in Table 4.1. Since Macknick's study [15] is the most comprehensive one, the WCFs presented in this study are used for the water consumption calculations. The WCFs which are used in this study are summarized in Table 5.6. The geothermal power plants withdraw large amount of water from the geothermal fields. The condensate exiting the turbine at the steam cycle is used in the cooling systems of the power plants. Nearly 70% of this amount evaporates in the cooling tower which justify the high usage of water for the geothermal power plants [14].

Table 5.6 Water consumption factors used in this study [15] [14]

Fuel Type	Cooling	WCF (m³/GWh)
Nuclear	Wet cooling tower	2543
	Once-through	1018
	Dry cooling system	-
Natural Gas	Wet cooling tower	749
	Once-through	378
	Dry cooling system	7.5
Coal	Wet cooling tower	2600
	Once-through	946
	Dry cooling system	106
Biogas	Wet cooling tower	889
	Dry cooling system	132
Geothermal	Wet cooling tower	5299
	Dry cooling system	511
PV	-	98

5.1.6 Total Water Consumption and Water Intensity (WI)

The factors presented in Table 5.6 are then used to calculate the water consumption of 361 thermoelectric power plants using the below equation.

$$PPWC = \sum_j^N \sum_i^M (GEN_{i,j} \times WCF_{i,j}) \quad (5.3)$$

where PPWC is the water consumption of all thermoelectric power plants (m^3), GEN is the amount of electricity generated (GWh) at each thermoelectric power plant, WCF is the water consumption factor based on fuel type and cooling system type (m^3/GWh), i is the power plant with specific cooling system in each fuel type, j is the power plant with specific fuel type, M is the number of power plant with specific cooling system in each fuel type, and N is the number of power plant with specific fuel type.

Water intensity represents how much water is used to generate one GWh of electricity based on the fuel type mixture used in Turkey. The WIs are calculated using the following equation.

$$WI = \frac{PPWC}{GEN} \quad (5.4)$$

where WI is the water intensity (m^3/GWh). This parameter is calculated for each scenario in this study, to compare the water consumption based on fuel type and cooling system mixture.

5.2 Model Development

The electricity generation planning model based on various fuel types is developed using Long Range Energy Alternatives Planning (LEAP). The model is developed

by taking 2016 as the base year and the generation mixture is estimated until 2035. LEAP supports electricity generation based on fuel types and facilitates the tracking of the energy generation based on the available resources and demand estimates. LEAP operates at two levels; where built-in equations are used for energy, emissions, cost-benefit, etc. calculations, or these equations can be entered as spreadsheet-like expressions by the user [16] .

The LEAP structure flow chart is presented in Figure 5.2. In the demand analysis part, the annual electricity demand estimates between 2017 and 2035 obtained from [7] are entered to examine how the total electricity generation based on various fuel types are dispatched over the study period by applying various scenarios. In this study, the demand is specified as a single branch from the electricity generation over the analysis time.

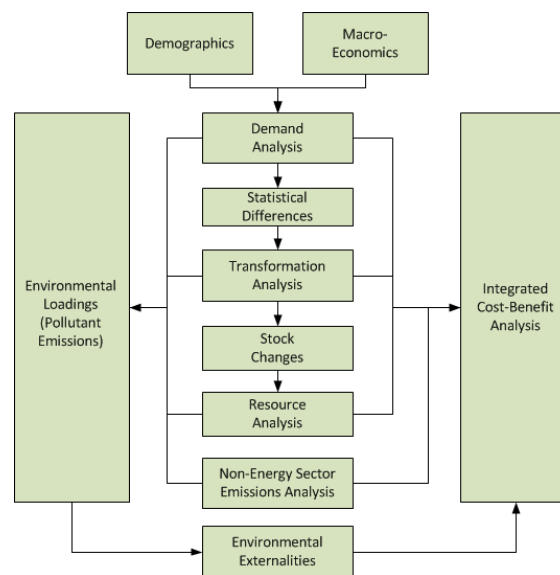

Figure 5.2 Flow chart of LEAP structure [16]

Electricity generation, distributing, and dispatching losses are placed in the transformation analysis branch in LEAP. Power plant lifetime, efficiency, maximum availability, and operation and investment costs are the technical parameters in LEAP. The analysis process starts with calculating the electricity requirements for each year according to the dispatch rule, followed by the cost calculations. These steps are repeated for each year, for each module such as natural gas, coal, solar,

etc. In this study, the transformation section includes only one branch which is electricity generation. The electricity generation includes the resources modules which are used to supply the electricity demand. As the distribution losses are not included in this study, the dispatch rule is used as the full capacity and the technical factors are entered for each module. Figure 5.3 shows the modules defined on LEAP in the transformation branch for this study. Many functions like Interp., Data, Growth etc. are predefined in LEAP. These functions are grouped according to their operations such as statistical, logical, financial, etc. The “Interpolation (Interp.)” function of LEAP is used in this study to calculate the straight-line change between specified pairs of data years and values [16].

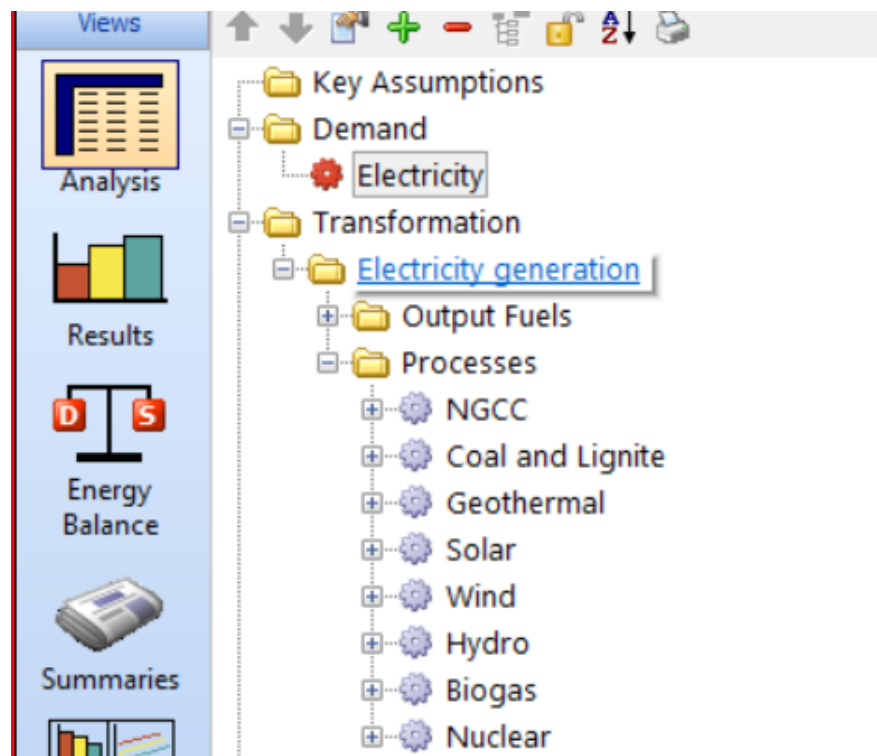

Figure 5.3 Generation fuel type modules defined on LEAP

5.2.1 Building the Baseline of the Model

The basic information about the base year is entered to the baseline of the model. This information is used to simulate the data for the upcoming years. The LEAP branches of the baseline can be built as:

- a. Demand: The total electricity demand for Turkey in 2016 is 270,526 GWh [6].

- b. Transformation Analysis: The electricity generation resources, fuel type share, and electricity generation data for the base year are provided to LEAP from [6].

5.3 Scenario Application

Identifying the parameters and using the functions are the requirements for applying the scenarios. Below are the assumptions applied to the scenarios.

- All current power plants are assumed to operate between 2017 and 2035.
- The renewable resources are limited in the maximum capacity function in LEAP using the potential of Turkey for each type Table 5.3 [7].
- The renewable energy potential is assumed to be used gradually during the study period.
- The losses are not accounted in this study.
- The dispatch rule is used as the full capacity.
- The share percentage of natural gas power plants is assumed to be between 30-40% over the years.
- The first unit of the nuclear power plants estimated to start to operate in 2022, and the remaining units will gradually start operating until 2029 as presented in Table 5.2.
- The load shape is based on the hourly data which is collected from the Load Distribution System website for Turkey in 2016 [72].
- The optimization model is based on water consumption for this study, however, there is no factor that takes into account the water consumption in LEAP. Thus, the optimization is conducted based on the variable cost (VC) which is replaced by the WCF, and the capital cost, fixed operational cost, and salvage cost are assumed to have a value of one unit for all modules.

5.3.1 Scenarios Description

Ten scenarios which are developed based on five cases for optimization are applied. These scenarios are explained below.

5.3.1.1 Business as Usual (BAU) Scenario

BAU Scenario is based on the current situation of the electricity generation in Turkey. Similar to the model baseline, the demand is taken as a single branch which is the electricity generation. The annual electricity generation demands estimations (from 2017 to 2035) were taken from [7] as presented in Table 5.4. In BAU Scenario the sharing of each fuel type is assumed to remain the same until 2022. After the nuclear power plants start to operate in Turkey in 2022, the remaining generation is then divided based on the shares of 2016. Thus, the annual installed capacities are calculated depending on the capacity factor and the electricity demand estimates of each fuel type using Equ 5.1 in LEAP and also in *MS Excel*. The WCF which are used in this scenario are presented in Table 5.7.

Table 5.7 Business as Usual (BAU) and optimization (OPT) scenarios water consumption factors

Fuel Type	WCF (m³/GWh)
Natural Gas	421
Coal and Lignite	1486
Geothermal	3164
Biogas	892
Nuclear Energy	1018
Hydropower	0
Solar Energy	98
Wind Energy	0

5.3.1.2 Optimization (OPT) Scenario

This scenario aims to optimize the water consumption based on fuel type. As stated before cost optimization is replaced by water consumption optimization at LEAP. The electricity generation by the resources modules is distributed to meet the demand according to the water consumption. Resources with low water consumption are preferred more than resources with high consumption according to each resource potential capacity by the simulation model. The dispatch rule is specified automatically from LEAP depending on the average WCF which is

described in Section 5.1 and presented in Table 5.7. Adjustments are done to the model, so all the current power plants continue to operate as they did in 2016 as given in Section 5.1.1.

The optimization in LEAP is done using OSMOSYS model in the program. In this study, the cost discount rate is assumed to be one. The OSMOSYS model objective function is calculated for each fuel type and year to minimize the cost of the system. The objective function is the minimum cost for all of the technologies over the year can be presented by the following equation.

$$LCE = \min(\sum_y \sum_t TDC_{y,t}) \quad (5.4)$$

Where LCE is the least cost electricity generation, $TDC_{y,t}$ is the total discount cost for each fuel type over the year (U.S. Dollar), y is the year, and the t is the fuel type. TDC is calculated using Equ. 5.5.

$$TDC_{y,t} = DOC_{y,t} + DCI_{y,t} - SV_{y,t} \quad (5.5)$$

where $DOC_{y,t}$ is the discount operating cost (U.S. Dollar), $DCI_{y,t}$ is discount capital investment (U.S. Dollar), and $SV_{y,t}$ is the salvage value (U.S. Dollar). DOC is calculated using Equ. 5.6.

$$DOC_{y,t} = OC_{y,t} * DF_{y,t} \quad (5.6)$$

where $DF_{y,t}$ is the discount factor which is assumed one in this study and $OC_{y,t}$ is the operating cost (U.S. Dollar) which is calculated as

$$OC_{y,t} = AVOC_{y,t} + AFOC_{y,t} \quad (5.7)$$

where $AFOC_{y,t}$ is the annual fixed operating cost and (U.S. Dollar). $AVOC_{y,t}$ is the annual variable operational cost (U.S. Dollar) which calculated as

$$AVOC_{y,t} = GEN * VC_{y,t} \quad (5.8)$$

where $VC_{y,t}$ is the variable cost (U.S. Dollar/ GWh) which is replaced by the WCF in this study, y is the year and t is the fuel type.

The discount capital investment is calculated in Equ. (5.9) as

$$DCI_{y,t} = CI_{y,t} * DF_{y,t} \quad (5.9)$$

where $CI_{y,t}$ is capital investment (U.S. Dollar) and it is calculated as

$$CI_{y,t} = CC_{y,t} * IC \quad (5.10)$$

where $CC_{y,t}$ is the capital cost (U.S. Dollar/MW)

$$SV_{y,t} = CC_{y,t} * IC_{y,t} * SF_{y,t} \quad (5.11)$$

where $SF_{y,t}$ is the salvage factor which is assumed one.

As the DF and SF are assumed one in Equ. 5.6, Equ. 5.9, and Equ. 5.11, the DCI and SV in Equ. 5.5 cancel out each other, and the optimization is then performed based on the WCF which represents the VC in Equ. 5.8.

5.3.1.3 Dry Cooling System (DCS_BAU) Scenario

In this scenario hypothetically, all power plants in Turkey are considered to use the dry cooling system instead of the cooling technologies that are currently used. The purpose of this scenario is to analyze how much water can be saved using the dry cooling systems at all power plants except nuclear power plants. Since there is no

WCF for dry cooling systems for nuclear power plants, they are assumed to use once through cooling systems as planned. To simulate this scenario in LEAP, the fuel type distribution is based on the BAU Scenario which is described in Section 5.3.1.1. However, the dry cooling system WCF for each fuel type is used instead of the WCF used at BAU Scenario. The WCF for the DCS are presented in Table 5.8.

Table 5.8 Water consumption factor for DCS_BAU and DCS_OPT Scenarios

Fuel Type	WCF (m³/GWh)
Natural Gas	8
Coal and Lignite	106
Geothermal	511
Biogas	132
Nuclear Energy	1018
Hydropower	0
Solar Energy	98
Wind Energy	0

5.3.1.4 DCS optimization (DCS_OPT) Scenario

Similar to DCS_BAU scenario, it is assumed again that all power plants use dry cooling system except for nuclear power plants. Instead of assuming the shares of each fuel type constant as done in BAU scenario, the technologies are optimized using OSMOSYS module in LEAP as done for OPT scenario which is described in Section 5.3.1.2. The WCF used in this scenario are presented in Table 5.8.

5.3.1.5 Wet Cooling Tower (WCT_BAU) Scenario

This scenario assumes that hypothetically the wet cooling towers are used as a cooling system for all the power plants in Turkey. The WCF for wet cooling towers are presented in Table 5.9. High water consumption values are expected in this scenario since the wet cooling towers are the highest water consuming system (for more details section 3.4). The fuel type distribution is based on the BAU scenario which is described in Section 5.3.1.1.

Table 5.9 WCT_BAU and WCT_OPT water consumption factors

Fuel Type	WCF (m³/GWh)
Natural Gas	749
Coal / Lignite	2600
Geothermal	5299
Biogas	889
Nuclear Energy	2543
Hydropower	0
Solar Energy	98
Wind Energy	0

5.3.1.6 WCT Optimization (WCT_OPT) Scenario

Similar to WCT_BAU scenario, it is again assumed that all power plants use wet cooling towers. The fuel type sharing of this scenario is based on the OPT scenario which is described in Section 5.3.1.2. The target of this scenario is to show the change in the water consumption when the WCT are used. The WCF in Table 5.9 are used in this scenario.

5.3.1.7 Once Through Cooling System (OTCS_BAU) Scenario

The fuel type distribution for this scenario is based on the BAU scenario (Section 5.3.1.1). The once through cooling system is hypothetically assumed as the used cooling system for all the fuel types except the geothermal and biogas in Turkey. Since there is no WCF for once through cooling system for geothermal and biogas power plants, they are assumed to use wet cooling tower as the current use. The aim from this scenario is to show the water consumption change when the once through cooling systems are used. The WCF which are used here are the OTCS ones as presented in Table 5.10.

Table 5.10 OTCS_BAU and OTCS_OPT water consumption factors

Fuel Type	WCF (m³/GWh)
Natural Gas	378
Coal /Lignite	946
Geothermal	5299
Biogas	889
Nuclear Energy	1018
Hydropower	0
Solar Energy	98
Wind Energy	0

5.3.1.8 OTCS Optimization (OTCS_OPT) Scenario

The goal of this scenario is to calculate the minimum water consumption based on the once through cooling system except the geothermal and the biogas. The fuel type distribution is based on the OPT scenario (Section 5.3.1.2). The WCF in Table 5.10 are used in this scenario.

5.3.1.9 High Dry Cooling System (HDCS_BAU) Scenario

In this scenario, a mixture of cooling systems is used based on the type of the fuel and the installed capacity. The dry cooling system shares based on the installed capacities of the natural gas, coal/lignite, geothermal and biogas are presented in Table 5.11. No changes were made for the nuclear power plants. The goal of this scenario is to reduce the water consumption and achieve a high cooling system efficiency. The WCF which are used in this scenario are displayed in Table 5.12. The fuel type distribution is based on the BAU Scenario (Section 6.3.1).

Table 5.11 Weighted average water consumption factor (WCF) in HDCS Scenario

Fuel Type	Cooling System Type	Assumed Percentages	WCF, (m ³ /GWh)	Weighted Avg. WCF, (m ³ /GWh)
Natural Gas	Dry cooling system	60%	7.5	230
	Wet cooling towers	20%	749	
	Once through	20%	378	
Coal/ Lignite	Dry cooling system	60%	106	773
	Wet cooling towers	20%	2600	
	Once through	20%	946	
Geothermal	Dry cooling system	60%	511	2426
	Wet cooling towers	40%	5299	
Biogas	Dry cooling system	60%	132	435
	Wet cooling towers	40%	889	

Table 5.12 HDCS_BAU and HDCS_OPT water consumption factors

Fuel Type	WCF (m ³ /GWh)
Natural Gas	230
Coal and Lignite	773
Geothermal	2426
Solar	98
Wind	0
Hydro	0
Biogas	435
Nuclear	1018

5.3.1.10 HDCS Optimization (HDCS_OPT) Scenario

The aim of this scenario is to calculate the minimum water consumption for the HDCS scenario. The generation share distribution of this scenario is same as OPT scenario (Section 5.3.1.2). The WCF present in Table 5.12. are used.

5.3.2 An Overview of Scenarios

The applied scenarios in this study are summarized in the following table.

Table 5.13 LEAP Scenarios

Scenario Name	Fuel Share Distribution		WCF
	BAU	OPT	
Business as usual (BAU)	√		Average WCF for each fuel type (Table 5.7)
Optimization (OPT)		√	
Dry cooling system (DCS_BAU)	√		Dry cooling system WCF except for nuclear (Table 5.8)
DCS Optimization (DCS_OPT)		√	
Wet Cooling Towers (WCT_BAU)	√		Wet cooling tower WCF (Table 5.9)
WCT Optimization (WCT_OPT)		√	
Once through cooling system (OTCS_BAU)	√		Once through cooling system WCF except for geothermal and biogas (Table 5.10)
OTCS Optimization (OTCS_OPT)		√	
High dry cooling system (HDCS_BAU)	√		Weighted average WCF except for nuclear (Table 5.12)
HDCS Optimization (HDCS_OPT)		√	

5.4 Closing Remarks

This chapter describes in detail the methodology of this study. Firstly, it is explained how the data are gathered and analyzed. Then, it presents how the baseline of the model was created. After that, the scenarios which are applied in LEAP software are described in detail.

6 RESULTS AND DISCUSSIONS

As stated in Chapter 5, this study consists of three stages which are the data analyzing, models development, and scenarios application, and the results for each stage of the study are presented. The first section of the chapter presents the current situation of the electricity generation in Turkey in 2016, which is the base year of the scenario applications. Then, the second section presents the fuel share distribution based on BAU and OPT approaches. The next section presents the results of the scenarios based on the water consumption and water intensities.

6.1 Current Status in Turkey

In the first phase of the study, the detailed power plant data is analyzed to determine the total water consumption based on cooling systems for each fuel type in 2016. Table 6.1 presents the cooling system distribution for each fuel type based on the number of the power plants. Table 6.2 presents the categorization of the cooling systems of the fuel types based on the installed capacities. As it can be seen from these tables, based on the number of power plants 64% of them are cooled by the DCS and 32% of them are cooled by the WCT. However, based on the installed capacities, the majority of natural gas and coal/lignite, all biogas, and half of geothermal power plants use wet cooling towers which consume more water than once through or dry cooling systems. Based on the total capacity, 44%, 30%, and 25% of the installed capacities of the power plants use WCT, OTCS, and DCS respectively. This shows that there are more number of power plants that use DCS, however the installed capacities of these power plants are lower than the ones using WCS.

Thopil *et al.* [61] mentioned the sharing percentage of the cooling systems for each fuel type in USA. In their study, the results showed that the majority of the natural gas and half of the coal and nuclear power plants use wet cooling towers which mostly consumes more water than the other cooling systems. These distributions are different than those presented in Table 6.2 for Turkey, which shows that half of the coal/ lignite fueled power plants use once through cooling systems and there

are no operating nuclear power plants. Thus, this leads to high water consumption per generated electricity in USA.

Table 6.1 Cooling system distribution based on number of power plants for each fuel type in 2016

Fuel Type / Cooling System	Once Through System		Wet Cooling Towers		Dry Cooling System	
	#	%	#	%	#	%
Natural gas	5	2%	17	8%	195	90%
Coal / lignite	9	24%	11	29%	18	47%
Biogas	-	-	78	100%	-	-
Geothermal	-	-	12	39%	19	61%
Total	14	-	118	-	232	-

Table 6.2 Cooling system distribution based on installed capacities for each fuel type in 2016

Fuel Type / Cooling System	Once Through System		Wet Cooling Towers		Dry Cooling System	
	MW	%	MW	%	MW	%
Natural gas	3811	16%	11699	48%	9000	37%
Coal / lignite	9280	53%	6562	37%	1668	10%
Biogas			436	100%		
Geothermal			429	55%	347	45%
Total	13091	-	19126	-	11015	-

By using the WCF determined from open literature (Table 5.6) for each cooling type used for each fuel type, total water consumption based on each fuel type is calculated using Equation 5.3. These values are then used to determine the water intensity (WI) based on each fuel type which is then used as average WCF for Turkey as presented in Table 6.3. As it can be seen in this table, the total water consumption at the electricity generation in Turkey is 188 million m³ in 2016. The maximum amount of water is consumed at the coal/lignite fueled power plants which is 71 % of the total consumption. This is due to the high electricity generation sharing percentage of coal/lignite fueled power plants, in parallel with the relatively high WCF of these types of power plants as given in Table 5.1 and Table 5.6. The natural gas fueled power plants consume nearly 20% of the total water consumption. While

the geothermal power plants have generation share less than 2%, they are ranked as the third highest water consumer and the highest WI among all fuel types due to the high WCF of this type of power plants as presented in Table 5.6.

Table 6.3 Water consumption, and water consumption intensity (WI) in 2016

Fuel Type	Generation (MWh)	Water Consumption (Thou. m ³)	Percentage %	WI based on Water Consumption (m ³ /GWh)
Natural Gas	90,993	38,292	20%	421
Coal and Lignite	90,262	134,114	71%	1486
Geothermal	4,214	13,333	7%	3164
Biogas	2,008	1,790	1%	892
Hydropower	67,067	0	0%	0
Solar Energy	612	60	0%	98
Wind Energy	15,370	0	0%	0
Total	270,526	187,588		693

In 2016, the total water consumption for the electricity generation in Turkey was 188 million m³. The amount of water consumed at power plants in 2016 represents almost 6% of the domestic water consumption and 8% of the industrial water consumption in 2014 (details in Section 1.3) [4]. In other words, almost 3.3 % of the non-agriculture water consumption (domestic + industrial) is used at the power plants in Turkey. In the U.S, 5% of the total water consumption, which is 12.5% of the non-agriculture consumption, is used at the electricity generation power plants in 2014 [73]. The share of nuclear power plant in the US is almost 20% of the total [74], and almost half of these power plants use wet cooling towers. There is currently no nuclear power plant in Turkey. Thus, mainly due to these reasons, the electricity sector water consumption share in the US is much higher than that of Turkey. Also, the amount of water consumed at power plants in 2006 corresponds to the amount of water consumed by about 2.5 million people in one year in Turkey based on TurkStat data for 2014 [75].

Scanlon *et al.* conducted a study in Texas, US, the WI for the electricity generation in 2010 was quantified as 1287 m³/GWh [53]. The WI determined in Scanlon *et al.*'s study is relatively higher the one estimated in this study. This is due to high share of nuclear power plants in Texas generation mixture which is 10%, and the high usage of wet cooling systems in this sector.

6.2 Fuel Share Distribution of the Scenarios

In this section, the resulted electricity generation mixture for each scenario is presented in tables and figures. Tables only show the results for the years 2016, 2020, 2025, 2030, and 2035, while the graphs show the results for all the years over the study period.

6.2.1 BAU Based Scenarios

For all the BAU based scenarios (BAU, DCS_BAU, WCTS_BAU, OTCS_BAU and HDCS_BAU scenarios), the shares of the fuel types in 2016 are assumed to be constant until 2022 as shown in Table 6.4 and Figure 6.1. After the nuclear power plants start to operate in Turkey in 2022, the remaining generation is then divided based on the shares of 2016 for the previous scenarios.

Table 6.4 Annual electricity generation shares for the BAU based scenarios (BAU, DCS_BAU, WCTS_BAU, OTCS_BAU and HDCS_BAU)

Fuel Type	2016	2020	2025	2030	2035
Natural Gas	33.6%	33.6%	29.7%	29.6%	30.5%
Coal and Lignite	33.4%	33.4%	29.5%	29.4%	30.1%
Geothermal	1.6%	1.6%	1.4%	1.4%	1.4%
Biogas	0.7%	0.7%	0.7%	0.7%	0.7%
Nuclear Energy	0.0%	0.0%	11.6%	12.0%	9.7%
Hydro	24.8%	24.8%	21.9%	21.8%	22.2%
Solar Energy	0.2%	0.2%	0.2%	0.2%	0.2%
Wind Energy	5.7%	5.7%	5.0%	5.0%	5.1%

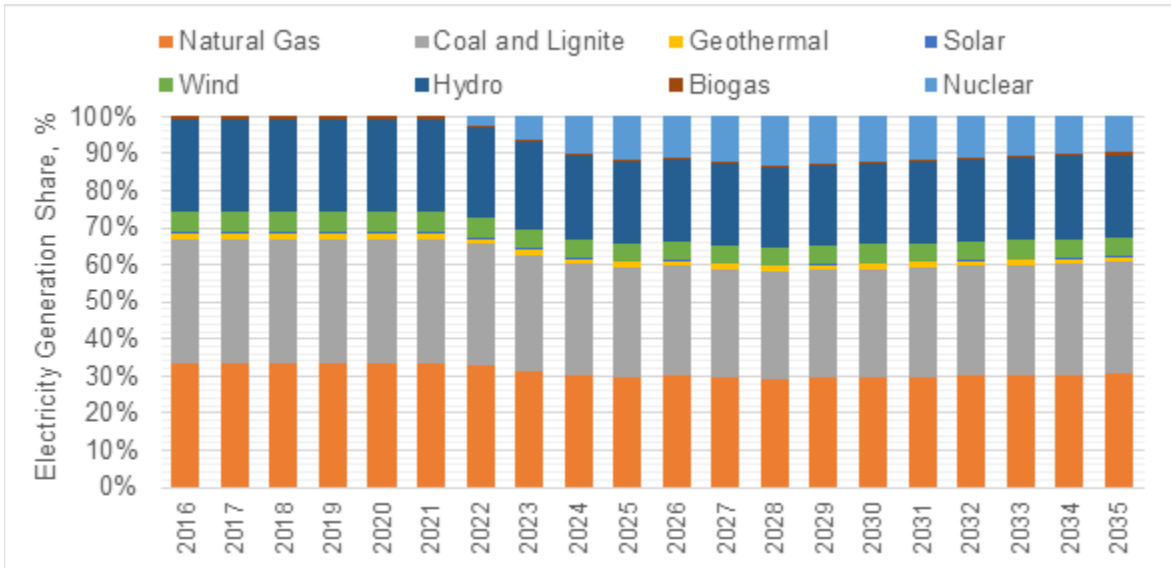

Figure 6.1 Annual electricity generation shares based on the BAU scenarios (BAU, DCS_BAU, WCTS_BAU, OTCS_BAU and HDCS_BAU)

6.2.2 Optimization Based Scenarios

The shares of fuel types for the OPT, WCTS_OPT, OTCS_OPT and HDCS_OPT scenarios are determined based on the optimization of minimum water consumption at LEAP program are presented in Table 6.5 and Figure 6.2 . As it can be seen here, the shares of technologies with high WCF, such as geothermal and coal/lignite power plants, are replaced by the ones with lower WCF. Even though the coal/lignite power plants have high WCF, their shares increase slightly after 2029 to supply the forecasted demand since other resources have reached their potential of dispatching. Despite the fact that the WCFs for the four mentioned optimization scenarios are different for each fuel type, they still have the WCFs ranking from the highest to the lowest. This explains why they have the same shares of fuel types.

Table 6.5 Annual electricity generation shares for the OPT, WCTS_OPT, OTCS_OPT and HDCS_OPT scenarios

Fuel Type	2016	2020	2025	2030	2035
Natural Gas	33.6%	34.0%	34.0%	34.0%	36.6%
Coal and Lignite	33.4%	21.9%	5.0%	7.3%	12.7%
Geothermal	1.6%	1.2%	0.9%	0.7%	0.6%
Biogas	0.7%	3.3%	5.0%	6.2%	6.5%

Fuel Type	2016	2020	2025	2030	2035
Nuclear Energy	0.0%	0.0%	11.6%	12.0%	9.7%
Hydro	24.8%	28.4%	31.3%	27.6%	22.2%
Solar Energy	0.2%	3.5%	6.0%	7.3%	7.8%
Wind Energy	5.7%	7.7%	6.2%	4.9%	4.0%

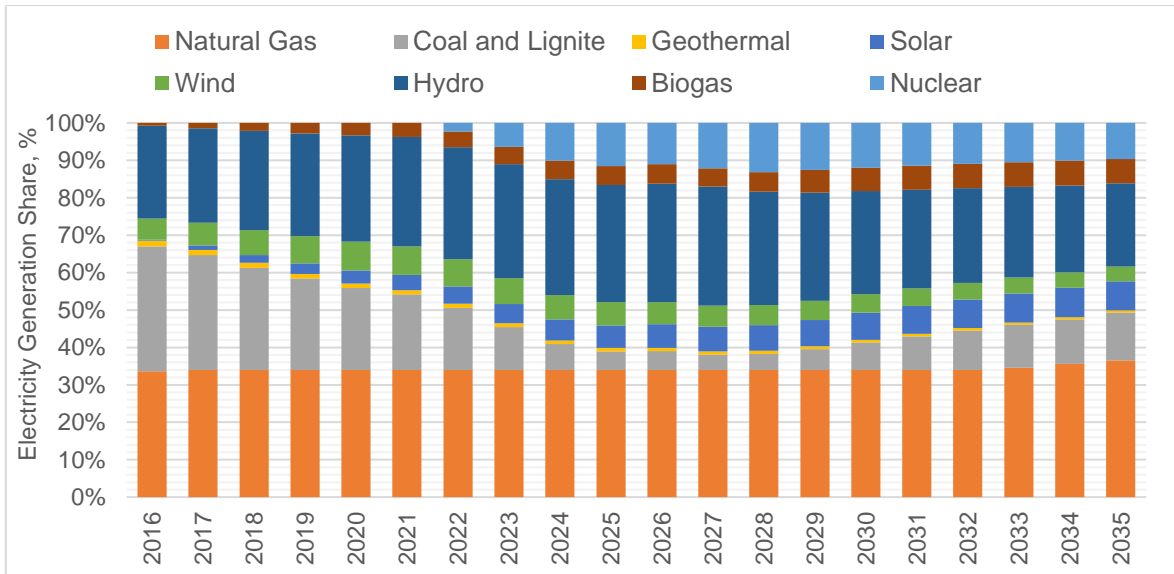

Figure 6.2 Annual electricity generation shares for the OPT, WCTS_OPT, OTCS_OPT and HDCS_OPT scenarios

The last optimization scenario applied to the LEAP model was the DCS_OPT which is based on optimizing the water consumption using dry cooling systems for all technologies, except the nuclear energy. The ranking of the WCFs for each fuel type in this scenario is different than the rest of the scenarios. To explain more, the WCF for the biogas in this scenario has a higher rank than the coal/lignite one, where the opposite is true for the other optimization scenarios. As can be seen in Table 6.6 and Figure 6.3, unlike the rest of the scenarios' results, the shares of biogas and geothermal power plants decrease over the years. Similar to the results of the other optimization scenarios, the share of coal/lignite power plants starts to increase after 2029.

Table 6.6 Annual electricity generation share for the DCS_OPT scenario

Fuel Type	2016	2020	2025	2030	2035
Natural Gas	33.6%	34%	34%	34%	36.6%
Coal / Lignite	33.4%	26.4%	9.6%	13.2%	18.9%
Geothermal	1.6%	1.2%	0.9%	0.7%	0.6%
Biogas	0.7%	0.6%	0.4%	0.3%	0.3%
Nuclear Energy	0%	0%	11.6%	12%	9.7%
Hydro	24.8%	28.4%	31.3%	27.6%	22.2%
Solar Energy	0.2%	3.5%	6.0%	7.3%	7.8%
Wind Energy	5.7%	6%	6.2%	4.9%	4%

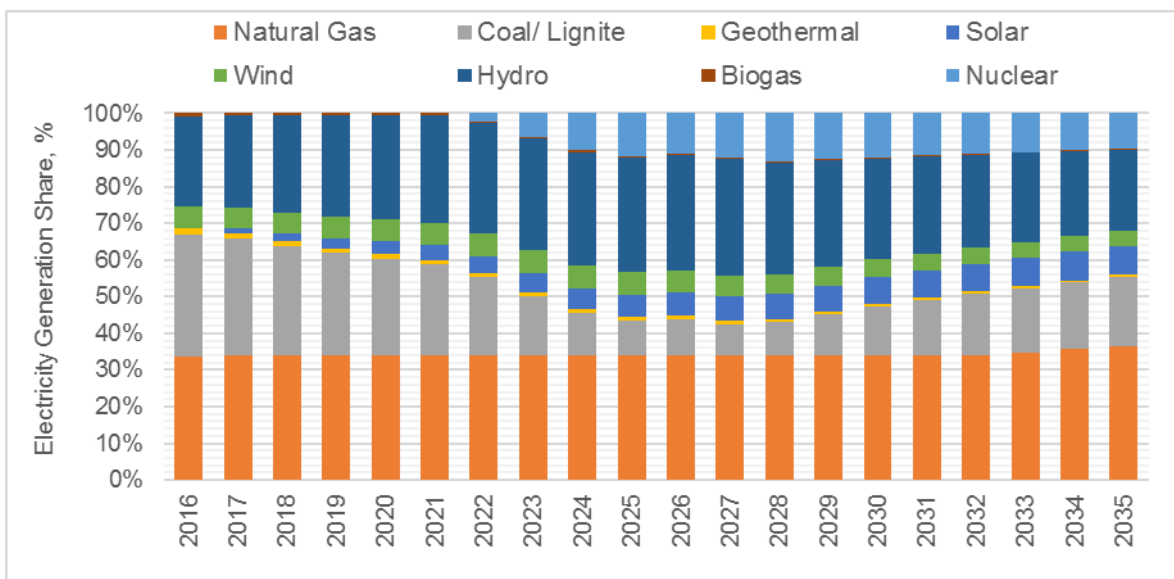

Figure 6.3 Annual electricity generation share for the DCS_OPT scenario

6.3 Water Consumptions and Intensities

In this section, using the estimated generation of each fuel type from LEAP model, the water consumption of each fuel type is calculated to determine the total water consumption between 2016 and 2035 for the applied scenarios. This calculated water consumption can be used to determine the optimal cooling system and fuel type mixture. Similar to the previous section, the results are presented in tables and figures. The tables only show the results for the years 2016, 2020, 2025, 2030, and 2035, while the graphs show the results for all the years over the study period.

6.3.1 BAU Scenario

As it can be noticed from Table 6.7 and Figure 6.4, BAU scenario results in an increasing trend in water consumption in all the years throughout the estimation period. The electricity demand in 2035 is expected to be double the amount in 2016, thus the total water demand is estimated to increase almost three folds by 2035 based on BAU scenario. Furthermore, once the nuclear power plants start to operate gradually between 2022 and 2028 as expected, there is an increase by 41% in this period. After 2028, the increasing rate of the annual water consumption stabilizes at about 5% until 2035.

Table 6.7 Water consumption (million m³) based on the BAU Scenario

Fuel Type	2016	2020	2025	2030	2035
Natural Gas	38	50	57	72	92
Coal and Lignite	134	176	200	253	322
Geothermal	13	18	20	25	32
Biogas	1.8	2.4	2.7	3.4	4.3
Nuclear Energy	0	0	54	71	71
Hydro	0	0	0	0	0
Solar Energy	0.06	0.08	0.09	0.11	0.14
Wind Energy	0	0	0	0	0
Total	188	247	334	425	522

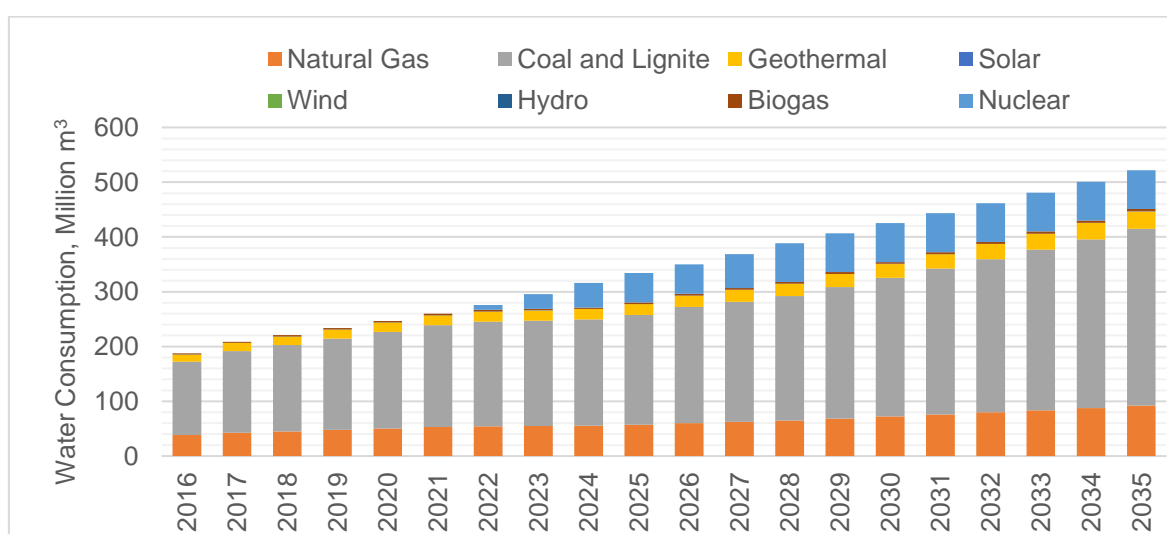

Figure 6.4 Water Consumption for the BAU Scenario

The calculated annual WIs based on the BAU Scenario are presented in Figure 6.5. It can be seen from the figure, as the electricity generation and the water consumption increase in parallel, the WI almost remains constant till 2021. After that, the nuclear power plants operation results in 1.1 % annual increase in 2022. The water intensity increases annually from 2022 to 2025. Then, there is a drop by 0.2% annually from 2025 to 2026. This drop results as there is no additional nuclear power plants units' operation as expected in 2026 as given in Table 5.2. After that, the WI starts to increase again until 2028 due to the operation of new nuclear power plants units. The WI keeps decreasing from 2029 to 2035. Overall, the total increase in WI is about 5% between 2016 and 2035.

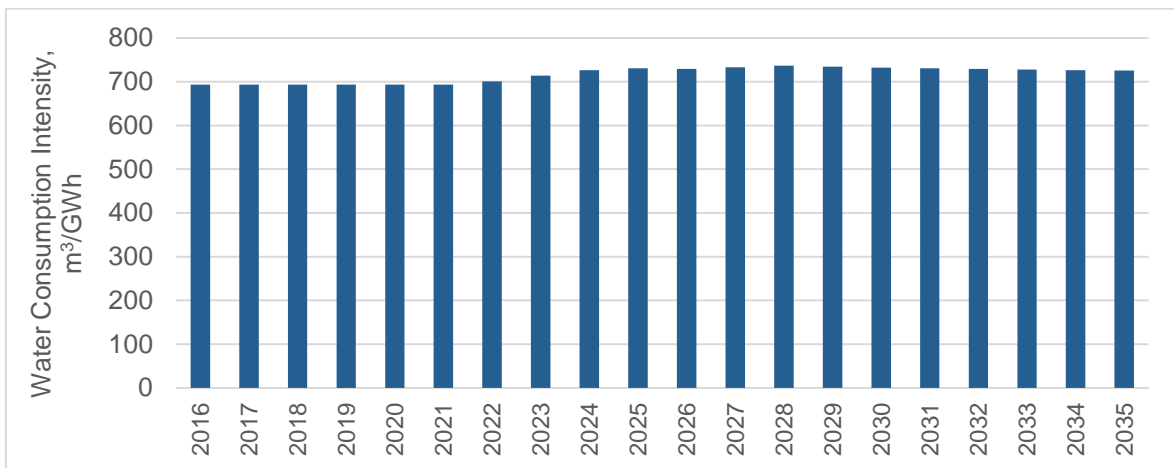

Figure 6.5 Water Intensities for the BAU Scenario

6.3.2 OPT Scenario

After optimizing the fuel shares, as presented in Table 6.8 and Figure 6.6, the increase in the total water consumption is not as strong as seen in the BAU Scenario. The optimization results in increasing the solar energy and the wind energy shares since the WCF of these technologies are lower than the others. The WCF of the coal/lignite (1486 m³/ GWh as presented in Table 5.7) is higher than the nuclear one (1018 m³/ GWh as presented in Table 5.7), thus the water consumption starts to decrease from 2017 to 2028. Since there are no additional nuclear power plants units starting to operate after 2028, the water consumption starts to increase.

This increase results from the increase of the coal/lignite distribution share. Overall, the water consumption is doubled from 2016 to 2035, while in the BAU Scenario it is three times higher over the same period. The water consumption is reduced by 144 million m³ and becomes 378 million m³ in 2035. This saving in water consumption in 2035 corresponds to the annual water consumption of about two million people based on based on TurkStat data for 2014 [75].

Table 6.8 Water consumption (million m³) based on the OPT Scenario

Fuel Type	2016	2020	2025	2030	2035
Natural Gas	38	51	65	83	111
Coal and Lignite	134	116	34	63	136
Geothermal	13	13	13	13	13
Biogas	1.8	10.5	20.4	32.3	41.4
Nuclear Energy	0	0	54	71	71
Hydro	0	0	0	0	0
Solar Energy	0.1	1.2	2.6	4.1	5.5
Wind Energy	0	0	0	0	0
Total	188	192	189	267	378

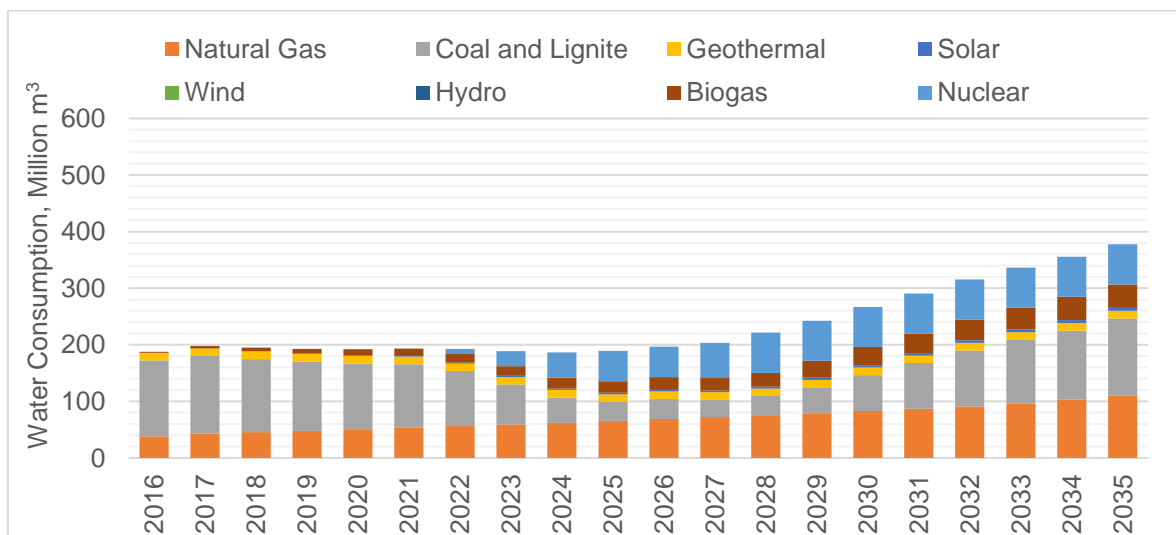

Figure 6.6 Water consumption (million m³) for the OPT Scenario

Figure 6.7 present the WI for the OPT scenario from 2017 to 2035. In the same way, the optimization results in decreasing the WI from 2017 to 2027. Between 2025 and

2026, a slight drop occurs in the WI as there are no new nuclear power plants starting to operate in 2026. After 2028, as the coal/ lignite shares start to increase, the WI starts to increase until the end of the study period. Overall the WI decreases from 696 m³/ GWh in 2016 to 525 m³/ GWh in 2035.

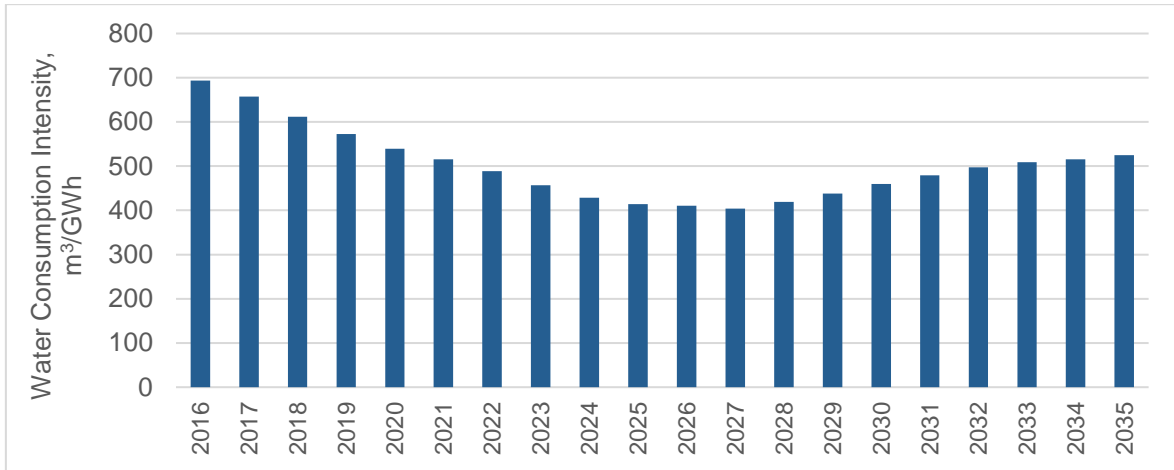

Figure 6.7 Water Intensities (m³/GWh) for the OPT Scenario

6.3.3 DCS_BAU Scenario

The dry cooling systems consume low amount of water, consequently using this cooling system would result in reducing the water consumption during the study period. Table 6.9 and Figure 6.8 display the DCS_BAU Scenario’s water consumption over the study years. Because of the increase in the electricity demand, the water consumption increases slightly from 2017 to 2021. Then, as the nuclear power plants start to operate, the water consumption increases by 55% from 2021 to 2022. The water consumption keeps increasing until 2028. After that, the water roughly increases from 94 million m³ in 2029 to 101 million m³ in 2035. The water consumption in this scenario is about one fifth of the one in the BAU Scenario in 2035.

Table 6.9 Water consumption (million m³) based on the DCS_BAU Scenario

WC, Millions m ³	2016	2020	2025	2030	2035
Natural Gas	0.68	0.90	1.02	1.29	1.65
Coal and Lignite	9.57	12.59	14.29	18.08	22.99

WC, Millions m³	2016	2020	2025	2030	2035
Geothermal	2.15	2.83	3.22	4.07	5.17
Biogas	0.27	0.35	0.40	0.50	0.64
Nuclear Energy	0	0	53.77	70.87	70.87
Hydro	0	0	0	0	0
Solar Energy	0.06	0.08	0.09	0.11	0.14
Wind Energy	0	0	0	0	0
Total	13	17	73	95	101

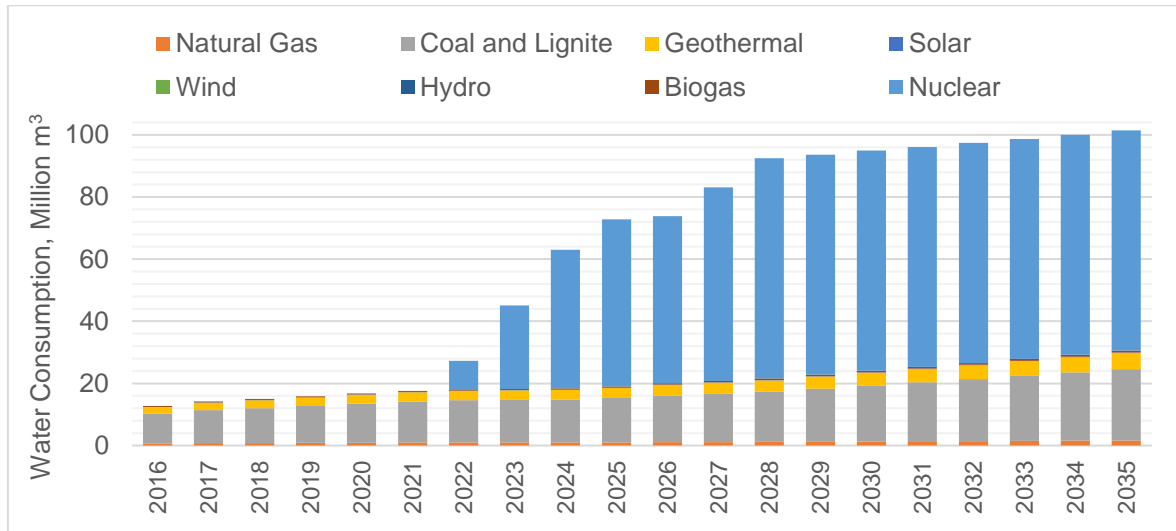

Figure 6.8 Water Consumption for the DCS_BAU Scenario

The calculated annual WIs based on the DCS_BAU Scenario are presented in Figure 6.9. It can be seen from the results, as the electricity generation and the water consumption increase in parallel, the WI remains almost constant till 2021. After that, the nuclear power plants are estimated to start operating in 2022, hence the annual WI increases until 2028. As mentioned before, no additional nuclear power plants are expected to start operating in 2026, so there is a slight drop from 2025 to 2026. After 2028, the WI starts to decrease. Compared to the BAU Scenario, based on this hypothetical scenario, the WI decreases from 693 m³/ GWh to 47 m³/ GWh in 2016, and from 726 m³/ GWh to 141 m³/ GWh in 2035.

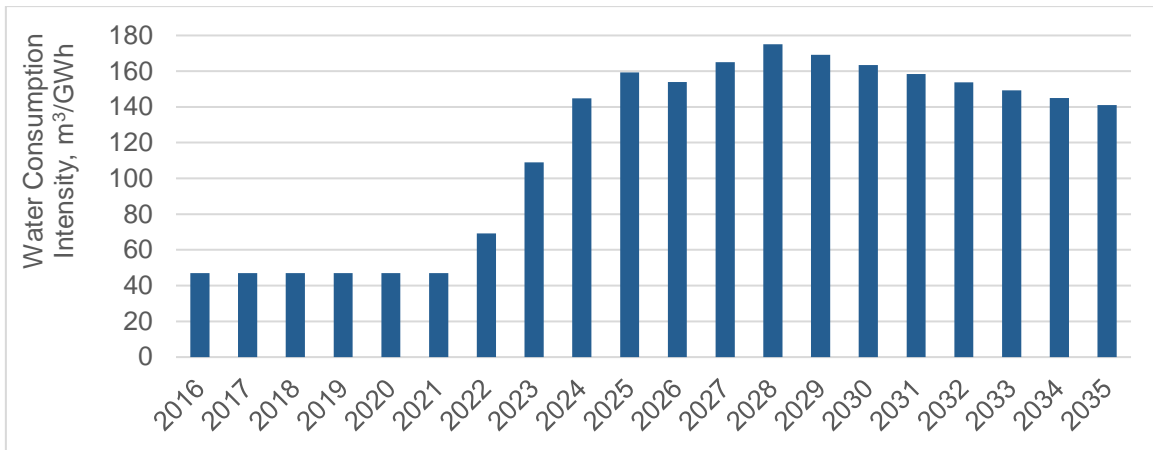

Figure 6.9 Water Intensities for the DCS_BAU Scenario

6.3.4 DCS_OPT Scenario

To find the minimum water consumed by the DCS, the DCS scenario is optimized based on the fuel type WCF. The resulted water consumptions of this scenario over the study period are displayed in Table 6.10 and Figure 6.10 . The total water consumption increases by 16 % from 2016 to 2021. Then, as the nuclear power plants are estimated to start operating, the water consumption suddenly increases from 15 million m³ in 2021 to 23 million m³ in 2022. The water consumption keeps increasing until it reaches 83 million m³ in 2028. After 2028, the annual increase nearly remains 2% until 2035 as there are no new nuclear power plants entering to the system. The water consumption increases 7.5 times from 2016 to 2035. The optimization resulted in a reduction of 6% from the DCS_BAU Scenario in 2035. Even though the dry cooling systems resulted in a high decrease in the water consumption, which would make them as a reliable option for the cooling system, they have lower heat transfer efficiencies compared to the wet cooling systems. This is due to the heat capacity difference between water and air. In addition, these systems have higher capital costs than those of the wet ones. Thus, it is almost impossible to apply this scenario in Turkey to all power plants. It is just a hypothetical scenario to show the water consumption change using the dry cooling systems at power plants.

Table 6.10 Water consumption (million m³) based on the DCS_OPT Scenario

WC, Millions m ³	2016	2020	2025	2030	2035
Natural Gas	0.68	0.91	1.16	1.48	1.97
Coal and Lignite	9.57	9.94	4.63	8.15	14.39
Geothermal	2.15	2.15	2.15	2.15	2.15
Biogas	0.27	0.27	0.27	0.27	0.27
Nuclear Energy	0	0.00	53.76	70.87	70.87
Hydro	0	0.00	0.00	0.00	0.00
Solar Energy	0.06	1.23	2.68	4.14	5.53
Wind Energy	0	0.00	0.00	0.00	0.00
Total	12.73	14.49	64.65	87.05	95.18

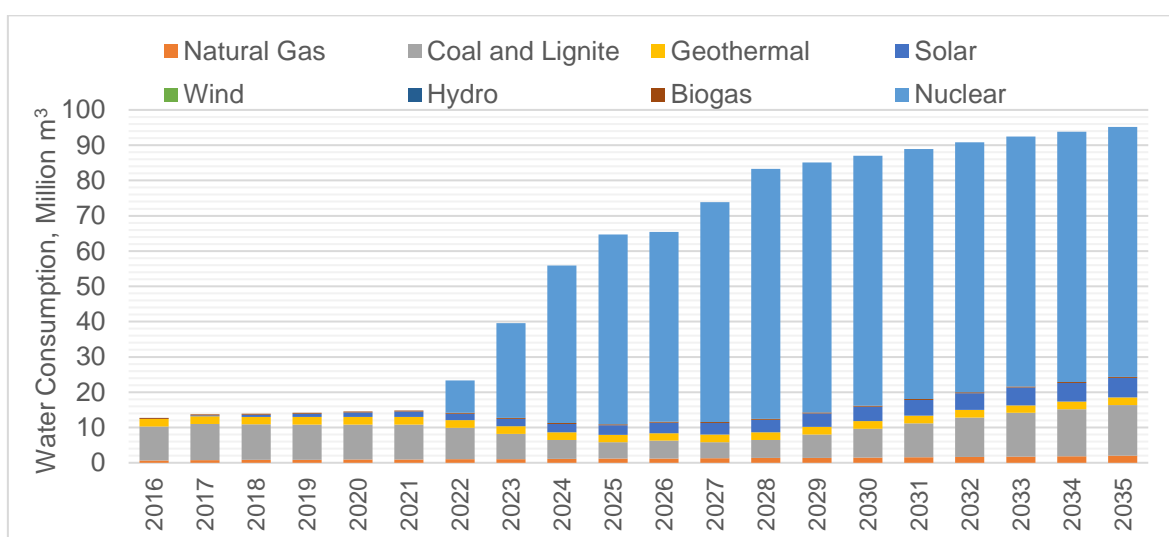

Figure 6.10 Water Consumption for the DCS_OPT Scenario

The annual WIs for the DCS_OPT Scenario are displayed in Figure 6.11. The water intensities decrease over the years from 2016 to 2021. Then, as the nuclear power plants start to operate in 2022, the WIs start to increase till 2028. After 2028, there are no new nuclear power plants, thus the annual WIs start to decrease again till the end of the study period. The water intensity increases from 47 m³/GWh in 2016 to 132 m³/GWh in 2035. In the same way of the water consumption, the water intensity decreases by 6 % compared to the BAU Scenario in 2035.

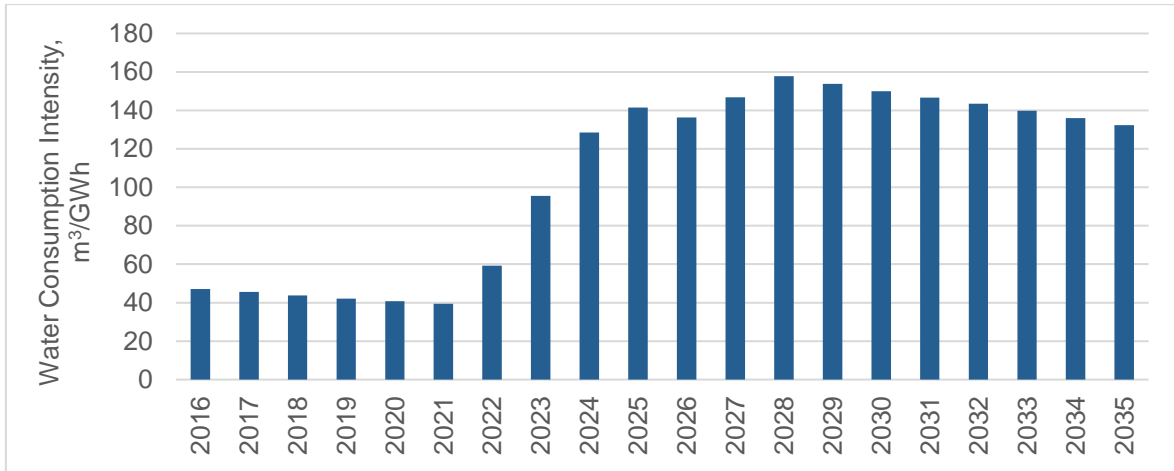

Figure 6.11 Water Intensities for the DCS_BAU Scenario

6.3.5 WCT_BAU Scenario

The purpose of this scenario is to present what happens if all the power plants use the wet cooling tower as the cooling system which is expected to result in high water consumption due to their high WCF. The annual water consumptions resulted from the scenario are presented in Table 6.11 and Figure 6.12. The water consumption increases by 38% from 2016 to 2021. Subsequently, as the nuclear power plants are estimated to start to operate, the water consumption increases by 50% from 2022 to 2028. After 2028, the annual increase remains 4% until 2035. The water consumption increases by nearly three folds from 2016 to 2035. The total water consumption in 2016 and 2035 are the double amounts in the BAU Scenario. Those results show that, if the wet cooling towers are used for all the thermal power plants, Turkey would face a threat for electricity generation in terms of water resources. On other words, it would not be able to supply the estimated demand due to the limitation of the water resources.

Table 6.11 Water consumption (million m³) based on the WCT_BAU Scenario

WC, Millions m ³	2016	2020	2025	2030	2035
Natural Gas	68	90	102	129	165
Coal / Lignite	235	309	351	443	564
Geothermal	22	29	33	42	54

WC, Millions m³	2016	2020	2025	2030	2035
Biogas	1.79	2.35	2.67	3.37	4.29
Nuclear Energy	0.	0	134.11	176.78	176.78
Hydro	0	0	0	0	0
Solar Energy	0.06	0.08	0.09	0.11	0.14
Wind Energy	0	0	0	0	0
Total	327	430	623	795	963

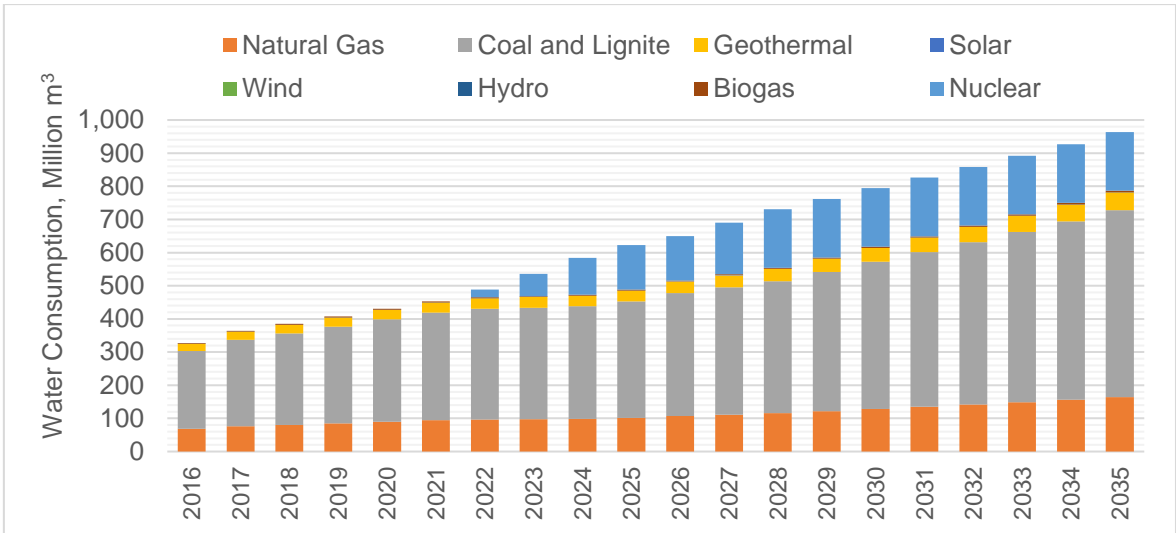

Figure 6.12 Water Consumption for the WCT_BAU Scenario

In the same manner, the high water consumptions result in high water intensities. The resulted WIs over the study period are displayed in Figure 6.13. Like the BAU based scenarios, the WI remains constant till 2021. Then, as the nuclear power plants are estimated to start operating, the WI increases by 12% from 2022 to 2028. After 2028, the WI decreases from 1384 m³/ GWh to 1339 m³/ GWh from 2029 to 2035. Overall, the WI in 2035 is nearly double the amount in 2016. The WI in 2016 and 2035 are almost two times more than the WI resulted in the BAU Scenario.

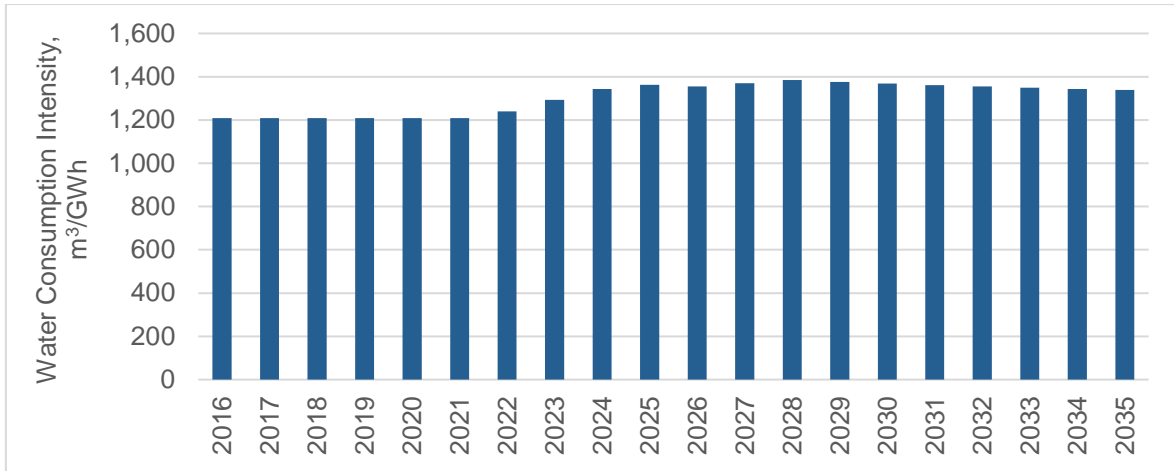

Figure 6.13 Water Intensities for the WCT_BAU Scenario

6.3.6 WCT_OPT Scenario

The WCT_BAU Scenario is optimized based on the WCF of the fuel type to determine the minimum water consumed by the WCT. After calculating the water consumption for this scenario throughout the study period, the results are presented in Table 6.12 and Figure 6.14. The water consumption decreases from 2017 until 2021. Then, as the nuclear power plants are estimated to start operating from 2021 to 2028, the water consumption increases by 26% in this period. As the WCF of wet cooling towers for the nuclear power plants (2543 m³/GWh as presented in Table 5.9) is slightly less than that of the coal/lignite power plants (2600 m³/GWh as presented in Table 5.9), the water consumption slightly increases after 2028 and reaches to 680 million m³ in 2035. The optimization approach saves 283 million m³ of water consumption based on the WCT_BAU scenario in 2035. Even the optimization is done, the WCT_OPT requires more 30% water than the water consumption resulted in the BAU Scenario.

Table 6.12 Water consumption (million m³) based on the WCT_OPT Scenario

WC, Millions m ³	2016	2020	2025	2030	2035
Natural Gas	68	91	116	148	197
Coal and Lignite	234.7	202.9	35.8	111.0	237.5
Geothermal	22.3	22.3	22.3	22.3	22.3
Biogas	1.8	10.5	21.3	32.2	41.3
Nuclear Energy	0	0	154.2	176.8	176.8

WC, Millions m ³	2016	2020	2025	2030	2035
Hydro	0	0	0	0	0
Solar Energy	0.1	1.2	2.7	4.1	5.5
Wind Energy	0	0	0	0	0
Total	327	328	353	494	680

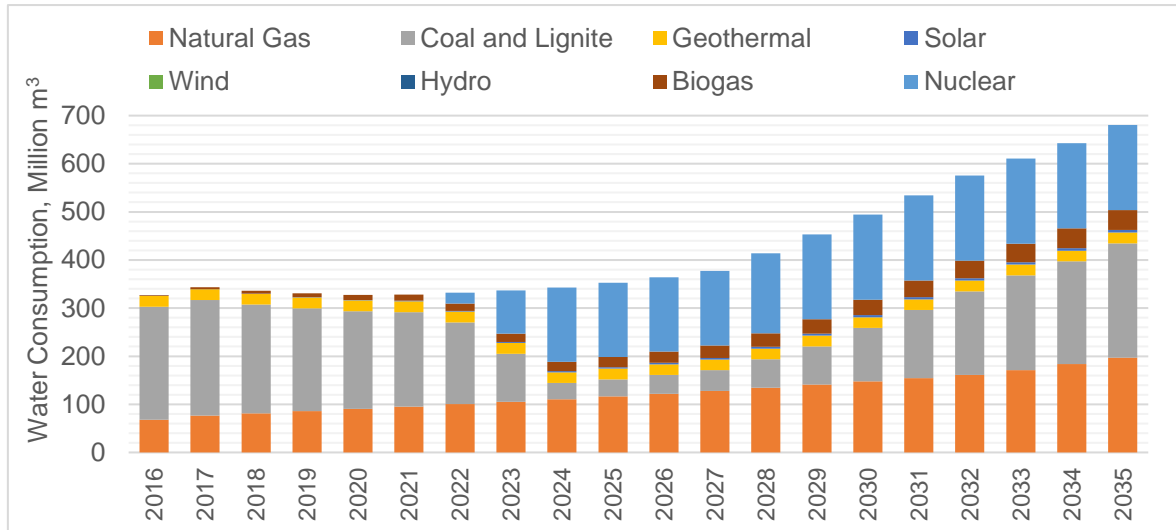

Figure 6.14 Water Consumption for the WCT_OPT Scenario

The resulted annual WIs are presented in Figure 6.15. The WI keeps decreasing till 2028. After that, the coal/lignite share starts to increase and hence the WI increases. Similar to the water consumption, the optimization reduces the water intensity by 29% from the WCT_BAU scenario in 2035. The WI of the WCT_BAU Scenario increases until 2035, however, the WI which is resulted from this scenario decreases by 22% from 2016 to 2035. Even the optimization is done, the WI is nearly double the WI resulted in the BAU Scenario.

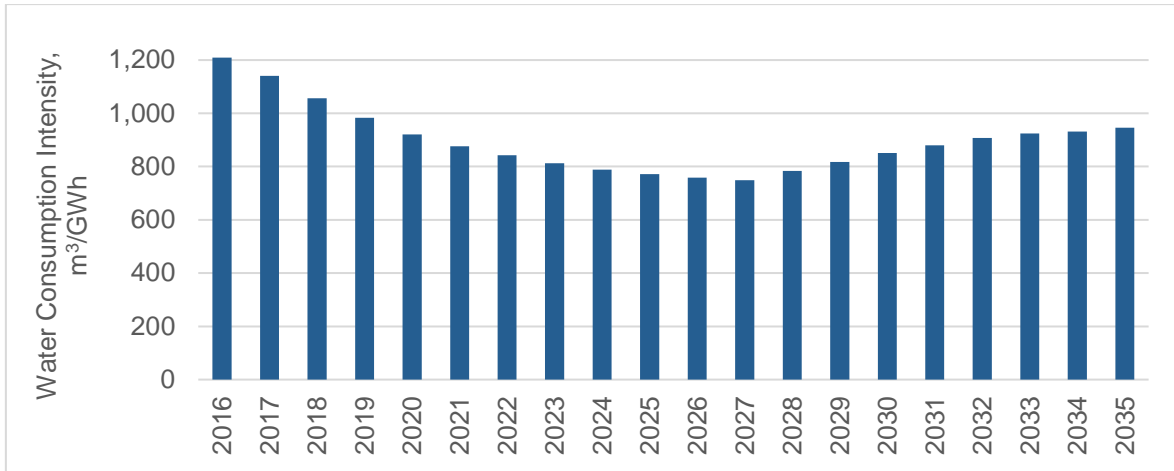

Figure 6.15 Water Intensities for the WCT_OPT Scenario

6.3.7 OTCS_BAU Scenario

Here, the once through cooling system (OTCS), which has higher consumption than the DCS and lower consumption than the WCT, is assumed to be used for all the Turkish power plants except the geothermal and biogas power plants. The annual water consumption for this scenario is displayed in Table 6.13 and Figure 6.16. The results show that the water consumption increases from 144 million m³ in 2016 to 417 million m³ in 2035. The highest annual increases occur from 2021 to 2028 due to the operation of the nuclear power plants. After 2028, the annual increase reduces to 4% until the end of the study. Overall, the water consumption increases by three folds from 2016 until 2035. The water consumption based on this scenario is four times more than the one in the DCS_BAU Scenario in 2035. On the other hand, this scenario results in two times less water consumption than the WCT_BAU Scenario in 2035.

Table 6.13 Water consumption (million m³) based on the OTCS_BAU Scenario

WC, Millions m ³	2016	2020	2025	2030	2035
Natural Gas	34	45	51	65	83
Coal and Lignite	85	112	128	161	205
Geothermal	22	29	33	42	54
Biogas	1.8	2.3	2.7	3.4	4.3
Nuclear Energy	0	0	54	71	71
Hydro	0	0	0	0	0
Solar Energy	0.06	0.08	0.09	0.11	0.14

WC, Millions m³	2016	2020	2025	2030	2035
Wind Energy	0	0	0	0	0
Total	144	189	269	343	417

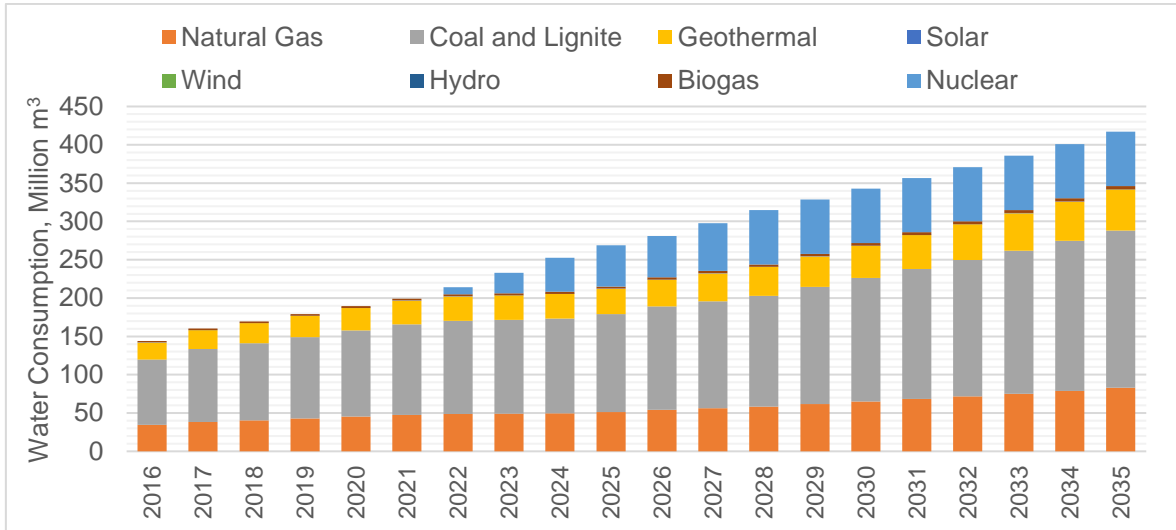

Figure 6.16 Water Consumption for the OTCS_BAU Scenario

The WIs for this scenario are presented in Figure 6.17. As mentioned before, the WI remains constant until 2021. As the nuclear power plants start to operate, the WI increases by 12% from 2021 to 2028. After 2028, the WI decreases to reach 580 m³/GWh in 2035. The WI is 75% more than the DCS_BAU Scenario and 57% less than the WCT_BAU Scenario in 2035. These percentages, which show that the OTCS Scenario results in a water consumption level between the levels of DCS and WCTS Scenarios, matches with the results from the previous studies [1] [31].

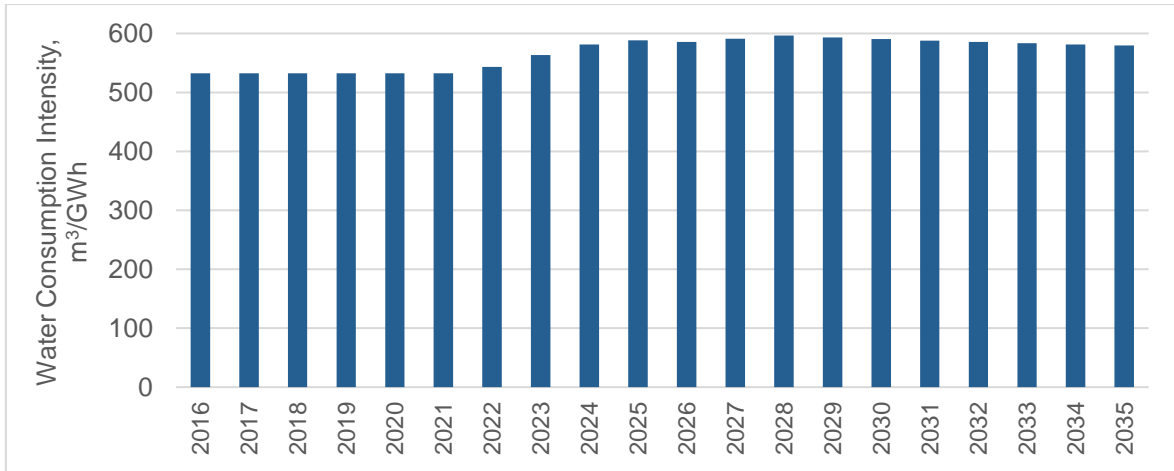

Figure 6.17 Water Intensities for the OTCS_BAU Scenario

6.3.8 OTCS_OPT Scenario

In order to find the minimum water consumption due to the electricity generation using the OTCS, the shares are optimized based on the WCF for this cooling system. Table 6.14 and Figure 6.18 present the water consumption resulted in this scenario over the study period. The water consumption increases from 144 million m³ in 2016 to 326 million m³ in 2035. The optimization reduces the water consumption by 22% based on the OTDCS_BAU Scenario in 2035.

Table 6.14 Water consumption (million m³) based on the OTCS_OPT Scenario

WC, Millions m ³	2016	2020	2025	2030	2035
Natural Gas	34	46	59	75	99
Coal and Lignite	85	74	13	40	86
Geothermal	22	22	22	22	22
Biogas	1.79	10.48	13.42	32.19	41.27
Nuclear Energy	0	0	71	71	71
Hydro	0	0	0	0	0
Solar Energy	0.06	1.23	2.68	4.14	5.53
Wind Energy	0	0	0	0	0
Total	144	154	181	244	326

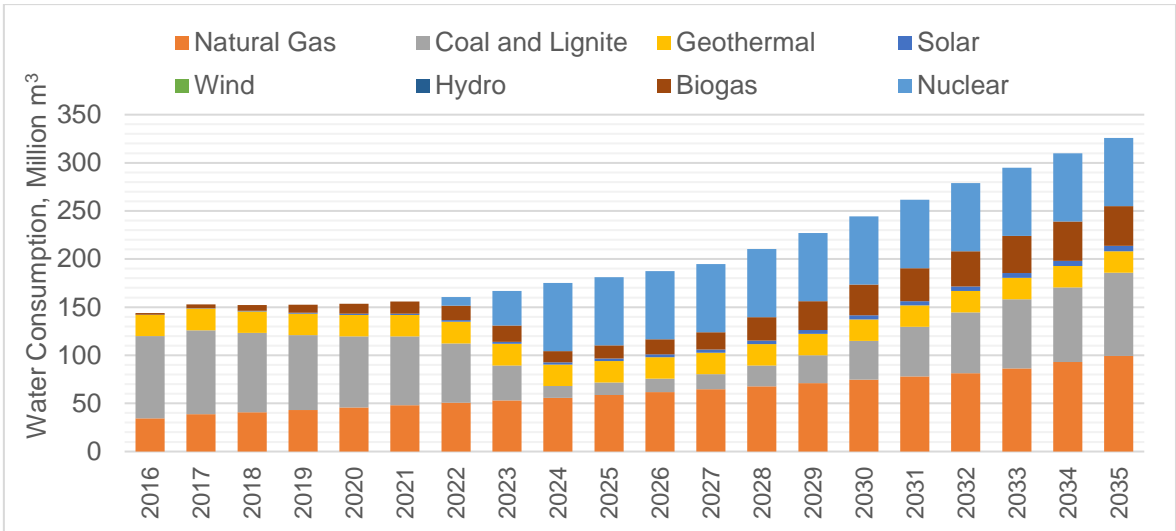

Figure 6.18 Water Consumption for the OTCS_OPT Scenario

The annual WIs based on this optimization are calculated and presented in Figure 6.19. The WI decreases from 2016 to 2027 based on the optimization. After 2027, the potential of the wind energy, solar energy, and hydropower has been reached. As a result, the shares of the other fuel types, which consume higher amounts of water such as biogas and coal/ lignite, increase. Thus, the WI increases by 55% from 2028 to 2035. Similar to the water consumption, the WI based on the optimization scenario is 22 % less than the OTCS_BAU Scenario. If OTCS are used, the power plants need to be located near an open source of water such as lake and sea. Thus, the use of this system would result in higher electricity transmission costs.

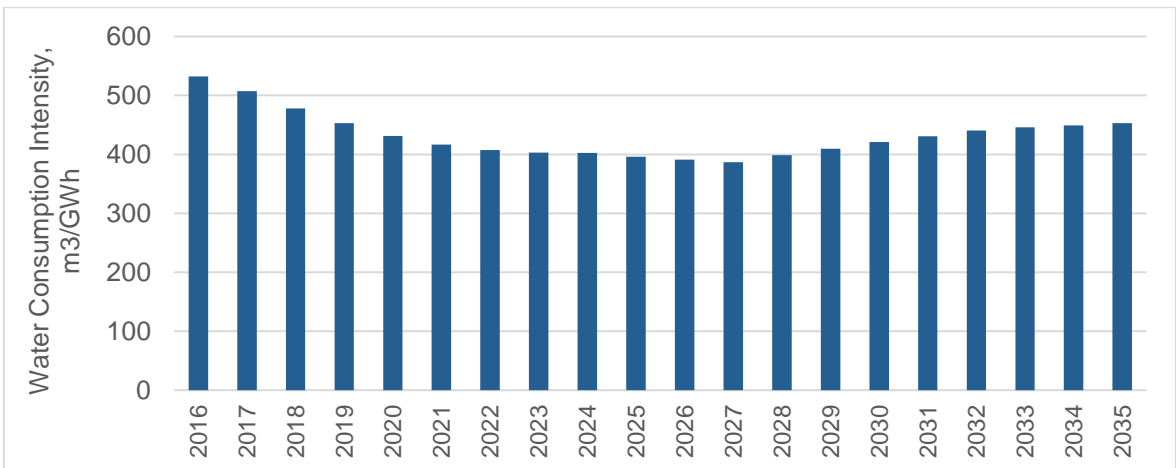

Figure 6.19 Water Intensities for the OTCS_OPT Scenario

6.3.9 HDCS_BAU Scenario

The dry cooling systems result in lower water consumption than the other systems, however, they have lower heat transfer efficiencies compared to the wet cooling systems. In order to reduce the water consumption and achieve a high cooling system efficiency, the HDCS_BAU Scenario is applied. In this scenario, the sharing percentage of the DCS based on the capacity is assumed to be higher than other cooling systems as explained in detail in Section 5.3.1.9. The water consumption based on this scenario during the study period is presented in Table 6.15 and Figure 6.20. The water consumption increases almost three folds from 2016 to 2035. The peak increase occurs from 2022 to 2028 due to the operation of the nuclear power plants. This scenario consumes 45% less water than the BAU Scenario in 2016, and consequently, it results in 40% water conservation in 2035, compared to the BAU Scenario.

Table 6.15 Water consumption (million m³) based on the HDCS_BAU Scenario

WC, Millions m³	2016	2020	2025	2030	2035
Natural Gas	21	28	31	40	51
Coal and Lignite	70	92	104	132	168
Geothermal	10	13	15	19	25
Biogas	0.9	1.1	1.3	1.6	2.1
Nuclear Energy	0	0	54	71	71
Hydro	0	0	0	0	0
Solar Energy	0.06	0.08	0.09	0.11	0.14
Wind Energy	0	0	0	0	0
Total	102	134	206	263	316

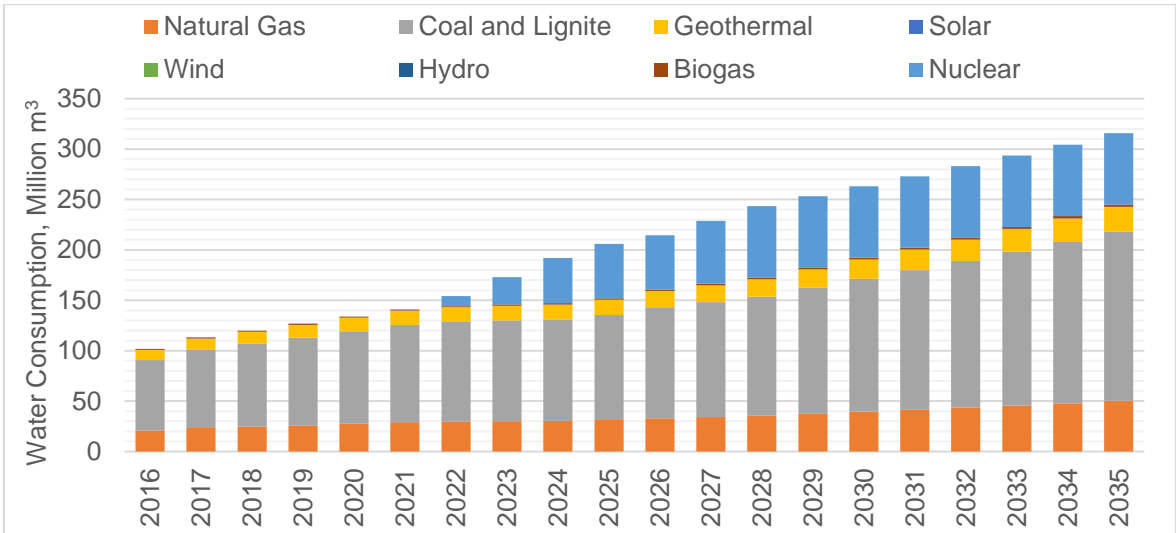

Figure 6.20 Water Consumption for the HDCS_BAU Scenario

The WIs for this scenario are presented in Figure 6.21. Similar to the BAU based scenarios, the WI remains constant until 2021. Then, the WI starts to increase from 2022 to 2028 due to the operation of the nuclear power plants. After 2028, the WI starts to decrease and the rate of decrease remains at 1% until 2035. The WI in 2035 is nearly double the one in 2016. The WI is 45% and 40% lower than the BAU Scenario in 2016 and 2035, respectively.

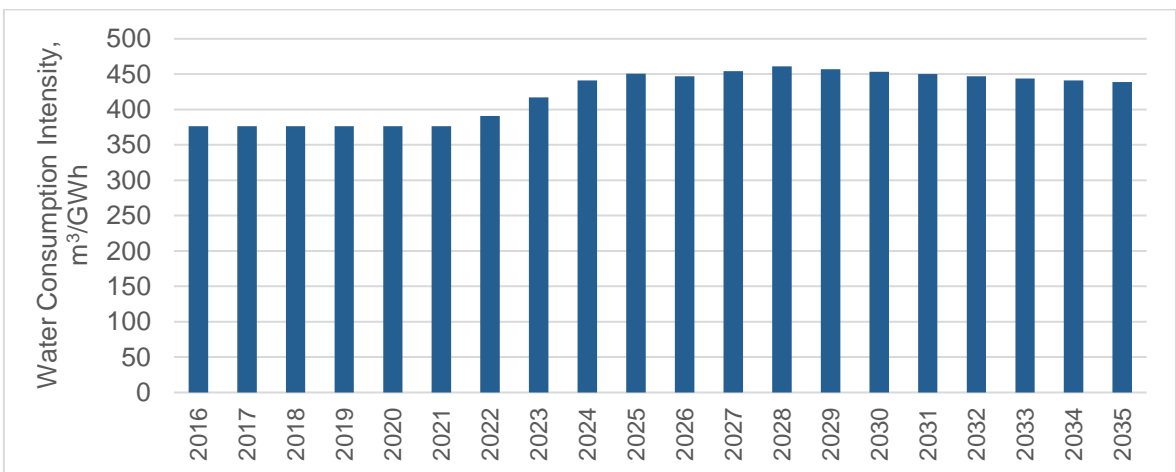

Figure 6.21 Water Intensities for the HDCS_BAU Scenario

6.3.10 HDCS_OPT Scenario

The annual water consumptions based on the HDCS_OPT Scenario, which are presented in Table 6.16 and Figure 6.22, are determined based on the optimization of minimum water consumption at LEAP program. The water consumption increases by 57% over the study period which is 10% lower than the increase resulted in the HDCS_BAU Scenario. The optimization reduces the water consumption by 25% compared to the HDCS_BAU Scenario in 2035.

Table 6.16 Water consumption (million m³) based on the HDCS_OPT Scenario

WC, Millions m ³	2016	2020	2025	2030	2035
Natural Gas	21	28	36	45	60
Coal and Lignite	70	60	11	33	71
Geothermal	10.2	10.2	10.2	10.2	10.2
Biogas	0.87	5.09	6.52	15.62	20.03
Nuclear Energy	0	0	71	71	71
Hydro	0	0	0	0	0
Solar Energy	0.06	1.23	2.68	4.14	5.53
Wind Energy	0	0	0	0	0
Total	102	105	137	179	238

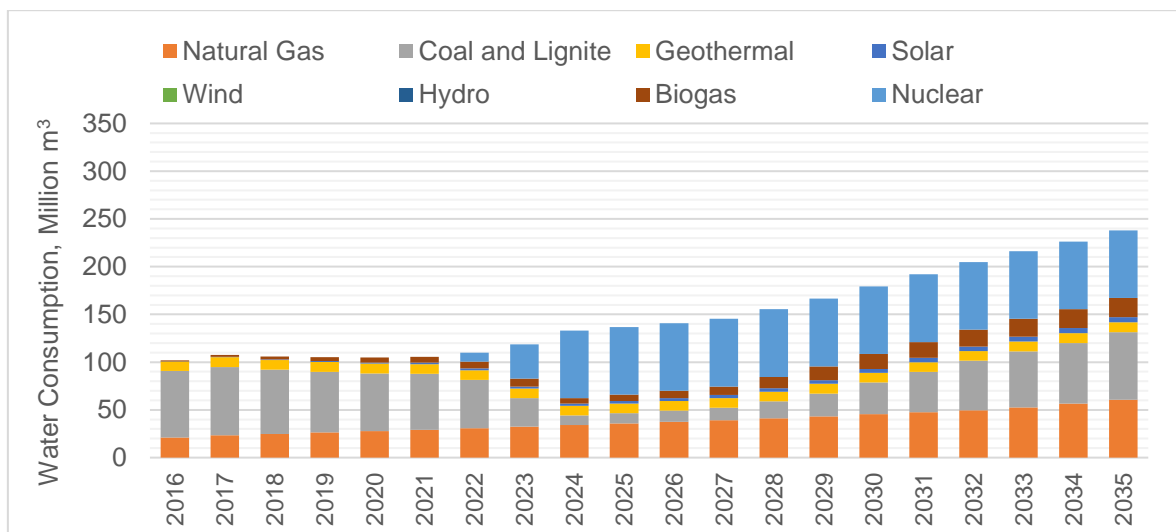

Figure 6.22 Water Consumption for the HDCS_OPT Scenario

The WIs of this scenario are presented in Figure 6.23 from 2016 to 2035. The WI decreases from 2017 to 2021 due to the water consumption optimization. Then, the WI increases from 2022 to 2028 due to the operation of the nuclear power plants. During this period, there is a peak and a drop. The peak appears in 2024 due to the addition of two nuclear power plants' units. The drop appears in 2026 as no new unit is added at that year. After that, the WI starts to increase again to reach 331 m³/GWh in 2035. The WI in 2035 is nearly double the one in 2016. The WI is 25% lower than the one in the HDCS_BAU Scenario in 2035.

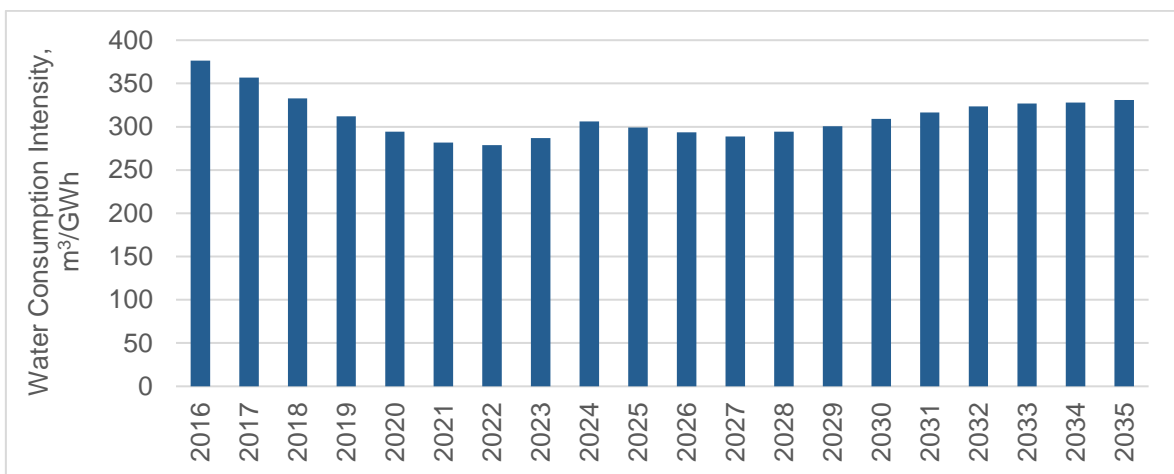

Figure 6.23 Water Intensities for the HDCS_OPT Scenario

6.3.11 Comparison of the Results of the Scenarios

The total difference in water consumption between 2016 and 2035 between the BAU scenario and the other applied scenarios in this study over the study period is presented in Figure 6.24. As it can be seen from the figure, the highest water reductions are due to the scenarios based on the dry cooling system (DCS_BAU and DSC_OPT). Also, it is noticeable that all of the scenarios except the WCT_BAU and WCT_OPT result in water consumptions lower than the BAU Scenario. However, the scenarios based on wet cooling system (WCT_BAU and WCT_OPT) result in more water consumption than the BAU Scenario by 45% and 12%, respectively.

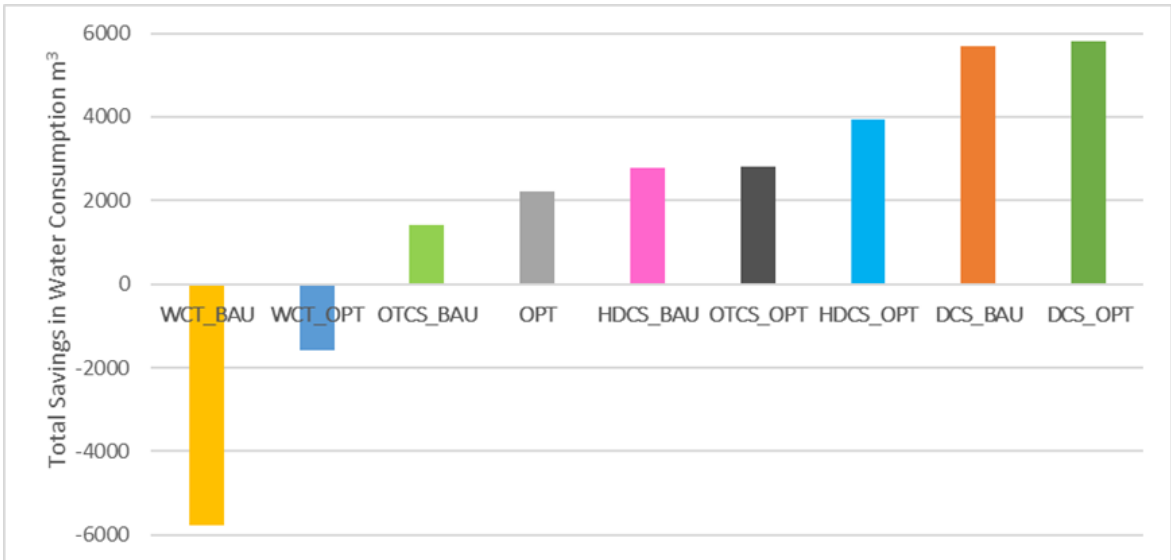

Figure 6.24 Total water consumption difference between the BAU scenario and the other applied scenarios over the study period (2016-2035)

The WI based on each applied scenario from 2016 to 2035 is presented in Figure 6.25. It is noticeable from the figure that the lowest intensities are from the scenarios based on the dry cooling system and the highest one for scenarios based on the wet cooling tower system.

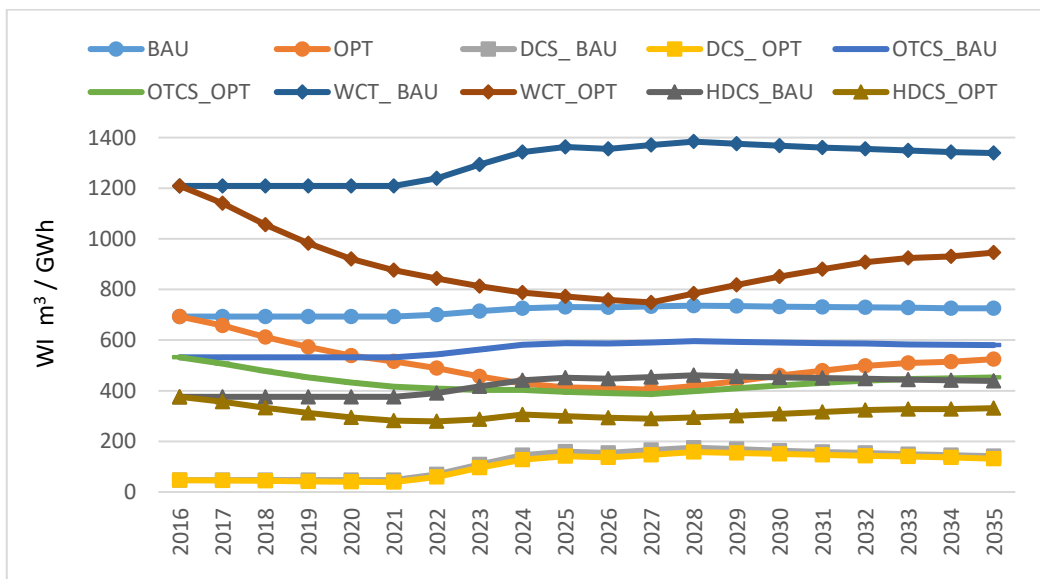

Figure 6.25 WI of the applied scenarios over the study period

In a similar project conducted in California, US, the annual WI was determined for the projected electricity generation [76]. The authors applied a scenario which includes an electricity generation mixture based on 50% DCS and 50% WTCS. They estimated that the WI would decrease from 1083 m³/GWh in 2010 to 965 m³/GWh in 2035. The WI determined in this study are relatively higher than the ones estimated in this study. This is due to high share of nuclear power plants in the generation mixture and the high usage of wet cooling systems. Whereas, there is currently no nuclear power plant in Turkey.

6.4 Closing Remarks

The methodologies detailed in Chapter 5 are used to determine the water consumption situation of the electricity generation sector in Turkey in 2016, to calculate the fuel share distribution based on BAU and OPT approaches, and the water consumption and intensities based on ten scenarios in the next 25 years. The results of the study show that based on the installed capacities in 2016, the majority of natural gas and coal/lignite, all of the biogas, and half of the geothermal power plants use wet cooling towers which consume more water than once through or dry cooling systems as of 2016. The total water consumption and water intensity in 2016 are determined as 188 million m³ and 693 m³/GWh, respectively. The water consumption of the power plants in 2016 is 8% of the industrial water consumption in 2014. This percentage and the water intensity in 2016 are lower than the results reported for other countries, such as seen in USA due to high share of nuclear power plants and use of wet cooling towers.

The water consumption and intensities for the next 25 years are determined based on ten scenarios which are developed based on various shares of fuel types and cooling technologies. The results of the scenarios show that the wet cooling tower based scenarios have the highest water consumption among all scenarios. Whereas, the dry cooling system based scenarios result in the least water consumption. Even though the dry cooling systems result in a high decrease in the water consumption which would make them as a reliable option as a cooling system,

they have lower heat transfer efficiencies than wet cooling systems. Thus, it is almost impossible to apply this scenario to all power plants in Turkey. It is just a hypothetical scenario to show the water consumption change using the dry cooling systems at power plants. Similarly, hypothetical scenarios based on using once through cooling system and wet cooling towers for almost all power plants are applied to determine the changes in water consumption levels. In order to reduce the water consumption based on BAU scenario and achieve a high cooling system efficiency, the HDCS_BAU Scenario is applied. This scenario results in 39% water conservation in 2035 compared to the BAU Scenario. In the next step, HDCS is optimized for further water savings. The results of the HDCS_OPT Scenario show that a reduction of 54% can be achieved based on the consumption level of the BAU Scenario in 2035.

7 Conclusion and Recommendations

This study aims to investigate the ways to reduce the water consumption due to the electricity generation at the Turkish power plants. In the first stage of the study, the amount of water (m³) consumed to generate 1 GWh of electricity based on each fuel type currently used and the total amount of water consumed at power plants in Turkey in 2016 are determined. Then, using LEAP, simulation scenarios are applied to investigate ways to reduce the water consumption per electricity generation at power plants expected to be built in the near future to supply the increasing demand. This study is an important step in determining the most preferred water cooling systems to be used based on fuel type in Turkish electricity sector. To the extent of our knowledge, this study is the first work analyzing the water consumption at Turkish electricity sector a simulation software.

The review of the previous studies on power plant water consumption showed that there are many studies conducted in USA to determine the water consumption factors for the various fuel types. Other studies are conducted to forecast the future water demands due to the electricity generation in various regions. Most of those studies use the WCFs determined by Macknik [15] When it comes to Turkey, only one study was found focusing on the water withdrawal, not the water consumption [48]. In addition, the simulation software used in this study, LEAP was used by Hasret [69] to analyze the de-carbonization of the public electricity sector in Turkey from 2001 to 2050.

The analyses of the study are conducted based on the current fuel mixture and also simulated fuel mixture of Turkish electricity sector. To achieve the objective of this study, this research is divided into three main steps. Firstly, data on the power plants, renewable energy potential, electricity demand forecasts, cooling system type of all power plants operating in 2016 (where available) at Turkey are collected from various sources [5] [6] to determine the water consumption of all current power plants. Due to the lack of the water consumption data, the WCFs from [15] [14] were used in this study. Then, analysis and statistical calculations were conducted on the data to draw a picture of the current state. The data analysis showed that the most common cooling system in Turkish power plants is the wet cooling system, which consumes the highest amount of water among all other cooling systems. Total water

consumption in 2016 is determined as 188 million m³, and the WI for 2016 is calculated as 693 m³/GWh. The water consumption of the power plants in 2016 is 8% of the industrial water consumption in 2014. This percentage and the water intensity in 2016 are lower than the results reported for other countries, such as seen in USA due to the high share of nuclear power plants and use of wet cooling towers.

The second step was developing a model to optimize the water consumption during the electricity generation using LEAP. The model is developed by taking 2016 as the base year and the generation mixture is estimated until 2035. After the model developed, the simulation scenarios are applied based on business as usual (BAU) and optimization (OPT) approaches. The BAU approach assumes the sharing of each fuel type remains at the percentages of 2016 until 2022. After the nuclear power plants start to operate in Turkey in 2022, the remaining generation is then distributed based on the shares of 2016. In the optimization approach, the electricity generation by the fuel type is distributed to meet the demand based on the water consumption factor.

In the last stage of the study, the model of each fuel type is used to build optimization scenarios based on proposed approaches using various WCFs. Based on BAU fuel mixture, the total water consumption is expected to increase by almost three folds in parallel to the estimated increase in demand. The scenario in which water consumption is optimized (OPT) resulted in about 25% reduction in water consumption in 2035.

In the third and fourth scenarios, it was assumed hypothetically dry cooling systems (DCS) are used for all thermoelectric power plants, except the nuclear power plants. The water consumption of the DCS_BAU Scenario is about one fifth of the BAU Scenario in 2035. Even though the dry cooling systems result in a high decrease in the water consumption, which would make them as a reliable option as a cooling system, they have lower heat transfer efficiencies than wet cooling systems. Thus, it is almost impossible to apply this scenario to all power plants in Turkey. It is just a hypothetical scenario to show the water consumption change using the dry cooling systems at power plants.

Similar to the previous scenarios, in the wet cooling tower (WCT) based scenarios, it was assumed hypothetically that all of the power plants are cooled using the wet cooling towers. The WCT_BAU Scenario resulted that the total water consumption in 2016 and 2035 are the double amounts determined in the BAU Scenario. Even the optimization is done, the WCT_OPT requires more 30% water than the water consumed in BAU Scenario. The high water consumption in the wet cooling towers shows that if these cooling systems are used for all the thermal power plants, Turkey would face a threat for electricity generation in terms of water resources.

In the OTCS_BAU and OTCS_OPT Scenarios, it was assumed hypothetically that all the power plants using the once through cooling systems. The results of this scenario present that the water consumption is four times more than the amount estimated by the DCS_BAU Scenario and two times less than the amount determined by the WCT_BAU Scenario in 2035. The optimization reduces the water consumption by 22% based on the OTDCS_BAU Scenario in 2035. In addition, based on these scenarios if OTCS are used, the power plants need to be located near an open source of water such as lake and sea. Thus, the use of this system would result in higher electricity transmission costs.

The business as usual based high dry cooling system (HDCS_BAU) Scenario is applied to reduce the water consumption based on BAU scenario and achieve a high cooling system efficiency. This scenario results in 39% water conservation in 2035 compared to the BAU Scenario. After optimizing this scenario, a reduction of 54% can be achieved based on the consumption level of the BAU Scenario in 2035.

The total water consumption savings based on the BAU Scenario from 2016 to 2035 are calculated and presented in the following table.

Table 7.1 Total water consumption difference between the BAU scenario and the other applied scenarios over the study period (2016-2035)

Scenario Name	Total Difference, million m³
WCT_BAU	-5763
WCT_OPT	-1575
OTCS_BAU	1421
OPT	2205
HDCS_BAU	2793
OTCS_OPT	2798

Scenario Name	Total Difference, million m ³
HDCS_OPT	3934
DCS_BAU	5696
DCS_OPT	5804

As it can be seen from the table, based on the BAU Scenario, the results of all scenarios present reduction in water consumption except ones based on the WCT. The scenarios based on wet cooling tower system (WCT_BAU and WCT_OPT) result in more water consumption than the BAU Scenario by 45% and 12%, respectively.

In a similar way, the water intensities determined based on the applied scenarios are compared. The comparison showed that the lowest intensities are from the scenarios based on the dry cooling system and the highest one for scenarios based on the wet cooling tower system.

The major outcomes of this study can be summarized as below.

- Wet cooling towers (WCT) are the widely used cooling systems in Turkey in 2016 based on the total installed capacity.
- The total water consumption and the water intensity due to the electricity generation in Turkey are 188 million m³ and 693 m³/GWh in 2016.
- Coal/lignite fueled power plants consume nearly 71% of the total water consumed at the electricity generation in Turkey in 2016.
- Based on the Business as Usual (BAU) Scenario the water consumption increases from 188 million m³ in 2016 to 522 million m³ in 2035.
- The optimization based BAU Scenario, the water consumption is reduced by 144 million m³ and becomes 378 million m³ in 2035. This saving in water consumption in 2035 corresponds to the annual water consumption of about two million people.
- The dry cooling system based scenarios achieve the highest water reduction among the other scenarios. Whereas, the wet cooling tower based scenarios have the highest amount.
- The scenario which assumes that the dry cooling systems are preferred more than the other systems, where available, results in reductions of 45% and 40% in 2016 and 2035, respectively.

The following policy suggestions can be made within the scope of the results obtained from this study:

- The hybrid wet-dry cooling system is recommended for newly built power plants, in which the wet component is operated in the hot days and the dry component is operated in the normal days.,
- The cooling systems of the power plants using wet cooling towers can be converted to the once through cooling systems if these power plants are located near a water source.
- Policies can be developed to promote the use of the dry cooling system for the power plants located at water poor regions.
- The share of renewable energy electricity generation should be increased to lower the water intensity of Turkish electricity sector.

7.1 Suggestions for Future Work

For the future work, the following can be implemented:

- In this study the analysis is based on fuel type. The analysis can be conducted based on each power plant in Turkey using LEAP. The analyses should be based on power plant; the consumptions can then be determined based on the addition of each new power plant.
- Here, the WCF are collected from the previous studies and are used for the water consumption calculations. In subsequent studies, the water consumption at the Turkish electricity sector can be determined using field data.
- The water consumption due to evaporation at hydropower plants are not considered in this study due to difficulty of obtaining required data for calculations. In the future, it can be calculated to determine the effect of the hydropower plants on the water consumption.
- The electricity losses are out of the scope of the study. The losses can be taken into account in the upcoming studies.

- In this study LEAP software was used in the optimization of the electricity mixture. The electricity mixture can also be modeled and optimized in different optimization software and the performance of the software can be compared.

REFERENCES

- [1] P. A. Torcellini, N. Long and J. Ron, Consumptive water use for US power production, *ASHRAE Winter Meeting*, California, **2003**.
- [2] Istatistics, Turkish Electricity Transmission Corporation, **2017**. [Online]. Available://www.teias.gov.tr/T%C3%BCrkiyeElektrik%C4%B0statistikleri /istatistik 2015 /istatistik2015.htm 55.xls. [Accessed 5 May 2017].
- [3] Water and DSI, General directorate of state hydraulic, **2009**. [Online]. Available: http://www2.dsi.gov.tr/english/pdf_files/dsi_in_brief2009.pdf. [Accessed 1 May 2017].
- [4] Main Statistics, Turkish Statistical Institute, [Online]. Available: <http://www.turkstat.gov.tr/Start.do>. [Accessed 17 May 2017].
- [5] Turkey electricity energy production capacity projection of 5 years (2015 - 2019), [Online]. Available: <http://www.teias.gov.tr /YayinRapor/apk/projeksiyon /index.htm>. [Accessed 23 December 2016].
- [6] Enerji Atlasi, [Online]. Available: <http://www.enerjiatlası.com/>. [Accessed December 2016].
- [7] Blue Book (Mavi kitap), MENR, **2015**. [Online]. Available: http://www.enerji.gov.tr/File/?path=ROOT%2f1%2fDocuments%2fMavi%20Kitap%2fMavi_kitap_2015.pdf. [Accessed 20 December 2016].
- [8] Enka engineering for a better future, **2016**. [Online]. Available: <http://www.enka.com/>. [Accessed 1 January 2017].
- [9] Green Power Through Innovation, **2016**. [Online]. Available: <http://exergy-orc.com> . [Accessed 1 January 2017].

- [10] Yenikoy thermal power plant, Yenikoykemerkoj, **2016**. [Online]. Available: <http://www.ykenerji.com.tr/tanitim/teknik-ozellikler/yenikoy-termik-santrali>. [Accessed 1 January 2017].
- [11] Integrated Pollution Prevention and Control Reference Document on Best Available Techniques for Large Combustion Plants, European Commission, **2006**. [Online]. Available: http://eippcb.jrc.ec.europa.eu/reference/BREF/lcp_bref_0706.pdf.
- [12] A. Ashwood and D. Bharathan, Hybrid cooling systems for low-temperature geothermal power production, National Renewable Energy Laboratory, USA, **2011**.
- [13] G. Tomberlin and G. Mosey, Feasibility Study of Economics and Performance of Biomass Power Generation at the Former Farmland Industries Site in Lawrence, Kansas, National Renewable Energy Laboratory (NREL), US, **2013**.
- [14] Energy demands on water resources: Report to Congress on the interdependency of energy and water, U.S. Department of Energy, US, **2006**.
- [15] J. Macknick, R. Newmark, G. Heath and K. Hallet, A review of operational water consumption and withdrawal factors for electricity generating technologies, NREL, US, **2011**.
- [16] Long-range Energy Alternatives Planning (LEAP), Stockholm Environment Institute, **2012**. [Online]. Available: www.energycommunity.org. [Accessed 16 November 2016].
- [17] J. Walker, Water energy nexus, in *The Texas Water Conservation Association Conference*, Texas, **2014**.
- [18] J. E. McMahon and S. K. Price, Water and energy interactions, *Annual review of environment and resources*, vol. 36, pp. 163-191, **2011**.

- [19] E. Mielke, L. D. Anadon and V. Narayanamurti, Water consumption of energy resource extraction, processing, and conversion, Belfer Center for Science and International Affairs, US, **2010**.
- [20] Coal Slurry Pipeline and Unit Train Systems, *Technology Assessment of Coal Slurry Pipelines*, United States, Congress of the United States, **2007**, pp. 27-59.
- [21] L. E. OTTS, Water requirements of the petroleum refining industry, USA: US Government Printing Office, **1963**.
- [22] Nuclear world association , [Online]. Available: <http://www.world-nuclear.org/nuclear-basics/how-is-uranium-ore-made-into-nuclear-fuel.aspx>. [Accessed 30 March 2016].
- [23] Y. A. Cengel and M. A. Boles, Thermodynamics: An Engineering Approach, United States: McGraw-Hill Education, **2014**.
- [24] J. A. Fay and D. Golomb, Energy and the Environment, United Kingdom: Oxford University Press, 2002.
- [25] J. J. BurkhardtIII, G. A. Heath and C. S. Turchi, Life Cycle Assessment of a Parabolic Trough Concentrating Solar Power Plant and the Impacts of Key Design Alternatives, *Environmental science & technology*, vol. 45, pp. 2457-2464, **2011**.
- [26] C. Clark , C. Harto, J. Sullivan and M. Wang, Water use in the development and operation of geothermal power plants, Argonne National Laboratory (ANL), US, **2010**.
- [27] D. Mohammed, Pressurized Water Reactor(PWR) VS Boiling Water Reactor(BWR)-2, Electrical Engineering Course, 6 December 2011. [Online]. Available: http://electrical-engineering-course.blogspot.com.tr/2011/06/pressurized-water-reactorpwr-vs-boiling_29.html. [Accessed 30 March 2016].

- [28] J. Yang and A. Yamazaki, *Water and Energy Nexus:A Literature Review*, California: Stanford University, **2013**.
- [29] T. J. Feeley, T. J. Skone, G. J. Stiegel, A. McNemar, M. Nemeth, B. Schimmoller, J. T. Murphy and L. Manfredo, Water: A critical resource in the thermoelectric power industry, *Energy*, vol. 33, pp. 1-11, **2008**.
- [30] A. Delgado and H. J. Herzog, *Simple model to help understand water use at power plants*, Cambridge: Massachusetts Institute of Technology, **2012**.
- [31] M. J. Rutberg, *Modeling water use at thermoelectric power plants*, USA: Massachusetts Institute of Technology, **2012**.
- [32] B. Lamy, G. Boardman and J. Bigger, Review of water use in US thermoelectric power plants, *Journal of Energy Engineering*, vol. 138, pp. 246-257, **2012**.
- [33] T. Havey, *California's Coastal Power Plants:Alternative Cooling System Analysis*, Golden Company, California, **2008**.
- [34] N. Nouri, *Water withdrawal and consumption reduction analysis for electrical energy generation system*, United States: University of Wisconsin-Milwaukee, **2015**.
- [35] J. Maulbetsch, *Comparison of Alternate Cooling Technologies for California Power Plants: Economic,Environmental, and Other Tradeoffs*, California Energy Commission, California, **2002**.
- [36] A. Delgado Martin, *Water Footprint of Electric Power Generation: Modeling its use and analyzing options for a water-scarce future*, Cambridge: Massachusetts Institute of Technology, **2012**.
- [37] P. H. Gleick, Water and energy, *Annual Review of Energy and the environment*, vol. 19, no. 1, pp. 267-299, **1994**.

- [38] EPRI, US water consumption for power production – the next half century, Electric Power Research Institute, US, **2002**.
- [39] G. J. Stiegel, J. R. Longanbach, . M. D. Rutkowski, M. G. Klett, N. J. Kuehn, R. L. Schoff, V. Vaysman and J. S. White, Power plant water usage and loss study, Technical report from US National Energy Technology Laboratory, US, **2005**.
- [40] J. Black, Bituminous coal and natural gas to electricity. Cost and performance baseline for fossil energy plants, National Energy Technology Laboratory, US Department of Energy, US, **2007**.
- [41] Estimating freshwater needs to meet future thermoelectric generation requirements, National Energy Technology Laboratory Department of Energy, USA, **2009**.
- [42] S. Vassolo and . P. Döll, Global-scale gridded estimates of thermoelectric power and manufacturing water use, *Water Resources Research*, vol. 41, no. 4, **2005**.
- [43] M. Z. Jacobson, Review of solutions to global warming, air pollution, and energy security, *Energy and Environmental Science*, vol. 2, no. 2, pp. 148-173, **2009**.
- [44] Form EIA-923 Power Plant Operations Report Instructions, US Energy Information Administration, USA, **2014**.
- [45] V. Fthenakis and C. H. Kim, Life-cycle uses of water in US electricity generation, *Renewable and Sustainable Energy Reviews*, vol. 14, no. 7, pp. 2039-2048, **2010**.
- [46] K. T. Sanders, Critical review: Uncharted waters? The future of the electricity-water nexus, *Environmental science and technology*, vol. 49, no. 1, pp. 51-66, **2014**.
- [47] J. Meldrum, S. Nettles-Anderson, G. Heath and J. Macknick, Life Cycle Water Use for Electricity Generation: A Review and Harmonization of Literature, *Environmental Research Letters*, vol. 8, pp. 15-31, **2013**.

- [48] H. Karakas and T. Tilki, *An Analysis of Effect of Water Resources Constraint on Energy Production in Turkey*, California: Naval Postgraduate School Monterey, **2012**.
- [49] D. Jiang and A. Ramaswami, The 'thirsty'water-electricity nexus: field data on the scale and seasonality of thermoelectric power generation's water intensity in China, *Environmental Research Letters*, vol. 10, no. 2, p. 024015, **2015**.
- [50] R. A. M. Peer and K. T. Sanders, Characterizing cooling water source and usage patterns across US thermoelectric power plants: a comprehensive assessment of self-reported cooling water data, *Environmental Research Letters*, vol. 11, no. 12, p. 124030, **2016**.
- [51] L. L. Dale, N. Karali, D. Millstein, M. Carnall, S. Vicuna , N. Borchers, B. Eduardo, J. O. Hagan, D. Purkey, C. Heaps, J. Sieber, W. D. Collins and M. D. Sohn, An integrated assessment of water-energy and climate change in Sacramento, California: how strong is the nexus?, *Climatic Change*, vol. 132, pp. 223-235, **2015**.
- [52] K. Strzepek, J. Baker, W. Farmer and C. Schlosser, Modeling water withdrawal and consumption for electricity generation in the United States, MIT Joint Program on the Science and Policy of Global Change, USA, **2012**.
- [53] B. R. Scanlon, . R. C. Reedy, I. Duncan, W. F. Mullican, and M. Young, Controls on water use for thermoelectric generation: case study Texas, US, *Environmental science and technology*, vol. 47, no. 19, pp. 11326-11334, **2013**.
- [54] E. G. Davies, P. Kyle and J. A. Edmonds, An integrated assessment of global and regional water demands for electricity generation to 2095, *Advances in Water Resources*, vol. 52, pp. 296-313, **2013**.
- [55] D. Murrant, A. Quinn and L. Chapman, Quantifying the UK's Future Thermal Electricity Generation Water Use: Regional Analysis, *International Journal of Social*, vol. 10, no. 3, pp. 750-759, **2016**.

- [56] M. Tran, J. Hall, A. J. Hickford and R. J. Nicholls, national infrastructure assessment: Analysis of options for infrastructure provision in Great Britain, Interim results, *Environmental Change Institute, University of Oxford*, p. 104, **2014**.
- [57] X. Liao, J. W. Hall and N. Eyre, Water use in China's thermoelectric power sector, *Global Environmental Change*, vol. 41, pp. 142-152, **2016**.
- [58] Utility Data Institute of Platts Energy InforStore, World Electric Power Plants, [Online]. Available: <http://www.platts.com>. [Accessed 2015].
- [59] P. Kyle, E. G. Davies, J. J. Dooley, S. J. Smith, L. E. Clarke, J. A. Edmonds and M. Hejazi, Influence of climate change mitigation technology on global demands of water for electricity generation, *International Journal of Greenhouse Gas Control*, vol. 13, pp. 112-123, **2013**.
- [60] J. J. Dooley, P. Kyle and E. G. Davies, Climate Mitigation's Impact On Global and Regional Electric Power Sector Water Use in the 21st Century, *Energy Procedia*, vol. 37, pp. 2470-2478, **2013**.
- [61] S. Talati, H. Zhai, G. p. Kyle, M. G. Morgan, P. Patel and L. Liu, Consumptive Water Use from Electricity Generation in the Southwest under Alternative Climate, Technology, and Policy Futures, *Environmental Science and Technology*, vol. 50, no. 22, pp. 12095-12104, **2016**.
- [62] R. Ghanadan and J. J. Koomey, Using energy scenarios to explore alternative energy pathways in California, *Energy Policy*, vol. 33.9, pp. 1117-1142, **2005**.
- [63] J. Islas, F. Manzini and O. Masera, A prospective study of bioenergy use in Mexico, *Energy*, vol. 32.12, pp. 2306-2320, **2007**.
- [64] R. Shabbir and S. S. Ahmad, Monitoring urban transport air pollution and energy demand in Rawalpindi and Islamabad using leap model, *Energy*, vol. 35.5, pp. 2323-2332, **2010**.

- [65] A. Ataei, J.-K. Choi, S. Shamshiri, H. Torabi and M. Nedaei, Evaluating of the Energy Consumption in Iran During 1980-2030 Using the Leap Model, *American Journal of Renewable and Sustainable Energy*, vol. 1.2, pp. 72-85, **2015**.
- [66] L. Dagher and I. Ruble , Modeling Lebanon's electricity sector: alternative scenarios and their implications, *Energy*, vol. 36, no. 7, pp. 4315-4326, **2011**.
- [67] J. Viola and C. Aceros, Smart Grids and their Applicability for the Development of the Electricity Sector for Colombia in the year 2050, *IOP*, vol. 138, no. 1, p. 012010, **2016**.
- [68] S. I. Khan , A. Islam and A. H. Khan , Energy Forecasting of Bangladesh in Gas Sector Using LEAP Software, *Global Journal of Research In Engineering*, vol. 11, no. 1, **2011**.
- [69] H. SAHIN, *Decarbonization of the Turkish public electricity sector: adopting sustainable energy portfolio*, Turkey: METU, **2014**.
- [70] M. E. Webber, D. F. Lawler, D. R. Maidment, D. C. McKinney and D. T. Allen, *Water impacts on thermoelectric power generation*, USA: The University of Texas at Austin, **2013**.
- [71] M. A. Koksall and I. Ari, Carbon dioxide emission from the Turkish electricity sector and its mitigation options, *Energy Policy*, vol. 39.10, pp. 6120-6135, **2011**.
- [72] Load distribution system, TEIAS, [Online]. Available: https://ytbs.teias.gov.tr/ytbs/frm_login.jsf. [Accessed 03 January 2017].
- [73] Water Currents, National Geographic, [Online]. Available: <http://voices.nationalgeographic.com/2014/03/28/to-understand-water-learn-the-math/>. [Accessed 17 may 2017].

- [74] Electricity in the United States, US Energy Information Administration , [Online]. Available: https://www.eia.gov/energyexplained/index.cfm?page=electricity_in_the_united_states. [Accessed 9 May 2017].
- [75] Municipal water statistics, TurkStat, **2014**. [Online]. Available: <http://www.tuik.gov.tr/PreHaberBultenleri.do?id=18779>. [Accessed 8 June 2017].
- [76] H. Cooley, J. Fulton, P. H. Gleick, N. Ross and P. Luu, Water for energy: Future water needs for electricity in the intermountain West, Pacific Institute, USA, **2011**.

APPENDICES

Appendix A

Calculated Capacities based on Generation Technologies in Turkey for BAU Scenario

The electricity production from each fuel type and its sharing percentage:

Power Plant type	2017		2018		2019		2020		2021	
	Share, %	GWh	Share, %	GWh	Share, %	GWh	Share, %	GWh	Share, %	GWh
Natural Gas	34%	101297	34%	107106	34%	113260.9	34%	119702.1	34%	125988.6
Coal and lignite	33%	100483	33%	106246	33%	112351.5	33%	118740.9	33%	124976.9
Geothermal	2%	4691	2%	4960	2%	5244.675	2%	5542.942	2%	5834.045
Biogas	0.7%	2236	0.7%	2364	0.7%	2499.633	0.7%	2641.788	0.7%	2780.529
Nuclear	0%	0	0%	0	0%	0	0%	0	0%	0
Hydropower	25%	74662	25%	78943	25%	83480.32	25%	88227.89	25%	92861.41
Solar	0.2%	682	0.2%	721	0.2%	762.1915	0.2%	805.5377	0.2%	847.8427
Wind	6%	17110	6%	18091	6%	19130.84	6%	20218.82	6%	21280.66
Total	100%	301160	100%	318430	100%	336730	100%	355880	100%	374570

Power Plant type	2022		2023		2024		2025		2026	
	Share, %	GWh	Share, %	GWh	Share, %	GWh	Share, %	GWh	Share, %	GWh
Natural Gas	33%	129466	31%	130365	30%	131586	30%	135914	30%	143577
Coal and lignite	33%	128427	31%	129318	30%	130529	30%	134823	30%	142424

Power Plant type	2022		2023		2024		2025		2026	
	Share, %	GWh	Share, %	GWh	Share, %	GWh	Share, %	GWh	Share, %	GWh
Geothermal	2%	5995	1.5%	6037	1.4%	6093	1.4%	6294	1.4%	6648
Biogas	0.7%	2857	0.7%	2877	0.7%	2904	0.7%	3000	0.7%	3169
Nuclear	2%	9000	6%	26400	10%	43800	12%	52800	11%	52800
Hydropower	24%	95425	23%	96087	22%	96987	22%	100177	22%	105825
Solar	0.2%	871	0.2%	877	0.2%	886	0.2%	915	0.2%	966
Wind	6%	21868	5%	22020	5%	22226	5%	22957	5.1%	24251
Total	100%	393910	100%	413980	100%	435010	100%	456880	100%	479660

Power Plant type	2027		2028		2029		2030		2031	
	Share, %	GWh	Share, %	GWh	Share, %	GWh	Share, %	GWh	Share, %	GWh
Natural Gas	30%	148733	29%	154222	29%	162880	30%	171901	30%	180670
Coal and lignite	29%	147539	29%	152984	29%	161572	29%	170521	30%	179219
Geothermal	1.4%	6887	1.4%	7141	1.4%	7542	1.4%	7960	1.4%	8366
Biogas	0.7%	3282	0.6%	3404	0.6%	3595	0.7%	3794	0.7%	3987
Nuclear	12%	61200	13%	69600	13%	69600	12%	69600	11%	69600
Hydropower	22%	109625	22%	113671	22%	120053	22%	126702	22%	133165
Solar	0.2%	1001	0.2%	1038	0.2%	1096	0.2%	1157	0.2%	1216
Wind	5%	25122	5%	26050	5%	27512	5%	29036	5%	30517
Total	100%	503390	100%	528110	100%	553850	100%	580670	100%	606740

Power Plant type	2032		2033		2034		2035	
	Share, %	GWh	Share, %	GWh	Share, %	GWh	Share, %	GWh
Natural Gas	30%	189698	30%	199015	30%	208645	31%	219740

Power Plant type	2032		2033		2034		2035	
	Share, %	GWh	Share, %	GWh	Share, %	GWh	Share, %	GWh
Coal and lignite	30%	188174	30%	197417	30%	206969	30%	216855
Geothermal	1.4%	8784	1.4%	9216	1.4%	9662	1.4%	10123
Biogas	0.7%	4187	0.7%	4392	0.7%	4605	0.7%	4825
Nuclear	11%	69600	11%	69600	10%	69600	10%	69600
Hydropower	22%	139819	22%	146686	22%	153784	22%	160000
Solar	0.2%	1277	0.2%	1339	0.2%	1404	0.2%	1471
Wind	5.1%	32042	5.1%	33615	5.1%	35242	5.1%	36925
Total	100%	633580	100%	661280	100%	689910	100%	719540

The following table presents the calculated installed capacities over the years:

Power Plant type	2017	2018	2019	2020	2021	2022	2023	2024	2025
	MW	MW	MW	MW	MW	MW	MW	MW	MW
Natural Gas	26892	28434	30068	31778	33447	34370	34609	34933	36082
Coal and lignite	19442	20557	21738	22974	24181	24848	25021	25255	26086
Geothermal	864	913	966	1021	1074	1104	1111	1122	1159
Biogas	491	519	549	580	610	627	632	638	658
nuclear	0	0	0	0	0	1200	3520	5840	7040
Hydropower	29390	31075	32861	34730	36554	37563	37823	38178	39434
Wind	6010	6354	6720	7102	7475	7681	7734	7807	8064
Solar	677	715	757	800	842	865	871	879	908
Total	83765	88568	93658	98984	104183	108259	111322	114651	119431

Power Plant type	2026	2027	2028	2029	2030	2031	2032	2033	2034	2035
	MW	MW	MW	MW	MW	MW	MW	MW	MW	MW
Natural Gas	38116	39485	40943	43241	45636	47964	50360	52834	55390	58336
Coal and lignite	27557	28546	29600	31262	32993	34676	36409	38197	40045	41958
Geothermal	1224	1268	1315	1389	1466	1540	1617	1697	1779	1864
Biogas	696	721	747	789	833	875	919	964	1011	1059
nuclear	7040	8160	9280	9280	9280	9280	9280	9280	9280	9280
Hydropower	41657	43153	44745	47257	49875	52419	55038	57741	60535	62982
Wind	8518	8824	9150	9663	10199	10719	11255	11807	12379	12970
Solar	959	994	1030	1088	1148	1207	1267	1329	1394	1460
Total	125767	131151	136810	143969	151429	158680	166145	173850	181813	189910

Appendix B

Water Intensities of the Applied Scenarios

Year	BAU	OPT	DCS_BAU	DCS_OPT	OTCS_BAU	OTCS_OPT	WCT_BAU	WCT_OPT	HDCS_BAU	HDCS_OPT
2016	693	693	47	47	532	532	1209	1209	376	376
2017	693	657	47	46	532	507	1209	1141	376	357
2018	693	612	47	44	532	478	1209	1056	376	333
2019	693	573	47	42	532	453	1209	983	376	312
2020	693	539	47	41	532	432	1209	920	376	294
2021	693	516	47	39	532	416	1209	876	376	282
2022	701	489	69	59	543	408	1239	843	391	279
2023	714	456	109	96	563	403	1294	813	417	287
2024	726	428	145	128	581	403	1343	788	441	306
2025	731	414	159	142	588	396	1363	772	451	299
2026	729	410	154	136	586	391	1355	759	447	293
2027	733	404	165	147	591	387	1371	749	454	289
2028	736	419	175	158	596	398	1384	784	461	294
2029	734	438	169	154	593	410	1376	818	457	301
2030	732	460	163	150	590	421	1368	851	453	309
2031	731	479	158	147	588	431	1361	880	450	316
2032	729	498	154	143	586	440	1355	908	447	323

Year	BAU	OPT	DCS_ BAU	DCS_ OPT	OTCS_BAU	OTCS_OPT	WCT_ BAU	WCT_OPT	HDCS_BAU	HDCS_OPT
2033	728	509	149	140	583	446	1349	924	444	327
2034	726	515	145	136	581	449	1343	931	441	328
2035	726	525	141	132	580	453	1339	946	439	331

CURRICULUM VITAE

Credentials

Name, Surname : Balkess EL-KHOZONDAR
Place of Birth : Palestine
Material Status : Married
E-mail : balkess-elkhonzondar@hotmail.com
Address :

Education

BSc. : B.Sc. in Environmental Engineer, with “Excellent” standing,
College of Engineer, Islamic University, Gaza, Palestine, 2014.

MSc. : Master degree in environmental engineer, Hacettepe University,
Ankara, Turkey, 2017.

PhD:-

Foreign Languages

Arabic “The native language”, English “The second language, have Excellent skills in spoken, reading as well as written English”, Turkish have Excellent skills in spoken, good skills in reading and writing.

Work Experience

- Environmental Engineer at Wastewater Treatment Unit, The Ministry of Agriculture (MOA) in Gaza.
- Environmental Engineer at “Promotion of environmental concern and practice partnership and the issue of community” project, MA’AN Development center in Gaza.

- Environmental engineer for using engineering data, engineering drawings and doing tables of quantities, Adana Co. for trading, Industry & contracting in Gaza.
- Environmental engineer for using engineering data, engineering drawings, make some reports, translate some environmental papers and do tables of quantities, Enfra consultants in Gaza.

Areas of Experiences

-

Projects and Budgets

-

Publications

- Participation in a paper entitled with “Potential of Nanofiltration for Pretreatment of Seawater Desalination in Gaza Strip” in the Fifth International Engineering Conference, Islamic University in Palestine.
- Participation in a paper entitled with “Investigating the water consumption for electricity generation at Turkish power plants” in the International conference on advances in energy systems and environmental engineering (ASEE17) in Wroclaw in Poland.

Oral and Poster Presentations

-



HACETTEPE UNIVERSITY
GRADUATE SCHOOL OF SCIENCE AND ENGINEERING
THESIS/DISSERTATION ORIGINALITY REPORT

HACETTEPE UNIVERSITY
GRADUATE SCHOOL OF SCIENCE AND ENGINEERING
TO THE DEPARTMENT OF Environmental Engineering

Date: 8.6.2017

Thesis Title / Topic: INVESTIGATING THE USE OF WATER FOR ELECTRICITY GENERATION AT TURKISH POWER PLANTS

According to the originality report obtained by myself/my thesis advisor by using the *Turnitin* plagiarism detection software and by applying the filtering options stated below on 8.../6.../2017 for the total of ..87..... pages including the a) Title Page, b) Introduction, c) Main Chapters, d) Conclusion sections of my thesis entitled as above, the similarity index of my thesis is ..5..... %.

Filtering options applied:

1. Bibliography/Works Cited excluded
2. Quotes ~~excluded~~ / included
3. Match size up to 5 words excluded

I declare that I have carefully read Hacettepe University Graduate School of Science and Engineering Guidelines for Obtaining and Using Thesis Originality Reports; that according to the maximum similarity index values specified in the Guidelines, my thesis does not include any form of plagiarism; that in any future detection of possible infringement of the regulations I accept all legal responsibility; and that all the information I have provided is correct to the best of my knowledge.

I respectfully submit this for approval.

Name Surname: BALKESS D. J. EL-KHOZONDAR

Student No: N14128034

Department: Environmental Engineering Department

Program: Master of Science

Status: Masters Ph.D. Integrated Ph.D.

Date and Signature

8-06-2017

Balkess

ADVISOR APPROVAL

APPROVED

Assoc. Prof. Dr. MERİH AYDINALP KÖKSAL

(Title, Name Surname, Signature)