

**DESIGN AND MANUFACTURING OF A DRYER USING
WASTE HEAT FROM A HOUSEHOLD REFRIGERATOR**

**EV TİPİ BUZDOLABINDAN ÇIKAN ATIK ISININ
KULLANILDIĞI BİR KURUTUCU TASARIMI VE
İMALATI**

ŞAHİN MURAT KARACAOĞLU

PROF. DR. BORA YILDIRIM

Supervisor

Submitted to

Graduate School of Science and Engineering of Hacettepe University

as a Partial Fulfillment to the Requirements

for the Award of Degree of Master of Science

in Mechanical Engineering

2023

Without thinking for a second, to my family...

ÖZET

EV TİPİ BUZDOLABINDAN ÇIKAN ATIK ISININ KULLANILDIĞI BİR KURUTUCU TASARIMI VE İMALATI

Şahin Murat KARACAOĞLU

Yükseklisans Tezi, Makina Mühendisliği Bölümü

Tez Danışmanı: Prof. Dr. Bora YILDIRIM

Haziran 2023, 83 sayfa

Bu tezde hem gıdaları soğutmak hem de çamaşırları kurutmak için harcanan enerjinin, araç gerecin, hacmin ve maliyetin azaltılmasını sağlayabilmek için ısı pompasının çift amaçla kullanımı incelenmiştir. Ev kullanımı tipi bir buzdolabının aynı ısı pompası çevrimi içinde hem çamaşır kurutma makinesi hem de buzdolabı elde edilecek bir sistemin çevrim prensipleri içinde kullanılabilmesi hedeflenmiştir. Çevre kirliliğinin doğal yaşama etkisinin her geçen gün artması, doğal kaynaklara ulaşımın her geçen gün zorlaşması ve uluslararası standartlar nedenleriyle ev cihazlarında enerji verimliliği oldukça önem arz etmektedir. Aynı zamanda kullanıcı konforu için de yaşam alanlarında yer tasarrufu ve program süresi önemlidir. Bu kapsamda konsept tasarım hesaplamaları gerçekleştirilen sistemin üretime yönelik tasarımı yapıp üretimi gerçekleştirilmiştir. Daha sonra farklı konfigürasyon ve element pozisyonlarında bir dizi test uygulanarak sistemin performansı ve verimliliği hesaplanmıştır. Tasarım, Solidworks üç boyutlu tasarım yazılımı kullanılarak gerçekleştirilmiştir. Tasarlanan sistem için kütle korunumu ve performans analizi yapılmıştır. Tasarım, 3 saat 38 dakikada 960 gram ıslak çamaşırda bulunan 320 gramlık ıslaklığı kurutmuş ve buzdolabının soğutma performansını da artırmıştır. Ayrıca, çamaşır kurutmada sağlanan enerji tasarrufuyla çamaşır kurutma haznesinin maliyeti 4 yıl 11 ay ve 5 gün sürelik bir kullanımdan sonra karşılanmaktadır. Isı pompası döngüsünün buzdolabı haznesinden soğurulan ısı ile çamaşır kurutma için harcanacak enerji tüketiminde azalma sağlanması tasarımın en büyük avantajıdır. Ana dezavantaj ise buzdolabı ve çamaşır kurutma makinesi haznelerinin fiziksel olarak yakın mesafede olması zorunluluğu evlerin iç mimari tasarımlarında köklü değişikliklere gidilmesini gerektirebilecektir. Ancak, bu

dezavantaj ekonomik ve çevresel verimliliđi önceleyen yeni nesil ev tasarımlarıyla veya karlılıđı ve tasarrufu gerekli kılan oteller gibi hizmet sektörü uygulamalarında sođutma ve ısıtma ihtiyacının aranacađı bölmelerin yakın tasarlanmasıyla (buzhane ve çamaşır kurutma odalarının yan yana olması gibi) aşılabilecektir.

Anahtar Kelimeler: Isı pompası, atık ısı tasarrufu, performans deneyi, buzdolabı, çamaşır kurutma makinesi

ABSTRACT

DESIGN AND MANUFACTURING OF A DRYER USING WASTE HEAT FROM A HOUSEHOLD REFRIGERATOR

Şahin Murat KARACAOĞLU

Master of Science, Department of Mechanical Engineering

Supervisor: Prof. Dr. Bora YILDIRIM

June 2023, 83 pages

In this thesis, the dual use of a heat pump is examined in order to avoid waste of energy and reduce the equipment, volume, and cost used for both cooling food and drying clothes. Energy efficiency in household appliances is very important due to the increasing impact of environmental pollution on natural life, the difficulty of accessing natural resources, and international standards. At the same time, living space saving and program duration are important for user comfort. In this context, the system is designed production-oriented, the concept design calculations were carried out. Then, the performance and efficiency of the system is calculated by applying a series of tests at different configuration and subcomponent positions. The design is drawn via Solidworks 3D design software. Conservation of mass and performance analysis is performed for the designed system. The designed system is dried 320 grams of wetness in 960 grams of wet laundry in 3 hours and 38 minutes and also is increased the the cooling performance of the refrigerator. In addition, with the energy savings achieved in clothes drying process, the cost of the clothes dryer chamber is amortised after 4 years, 11 months and 5 days of use. The biggest advantage of the design is to reduce the energy consumption of the clothes dryer chamber thanks to the usage of waste heat that is drawn from the refrigerator part of the heat pump cycle. On the other hand, the main disadvantage is that the refrigerator and clothes dryer chambers have to be physically nearby, which may require radical changes in the interior architecture design of the houses. However, this disadvantage can be eliminated by new generation house designs that prioritize economic and environmental efficiency, or by designing the compartments where cooling and heating are required (for example, an ice room and clothes drying room can be designed side by side) in the service sector applications such

as hotels that require profitability and efficiency. In addition, it can be a solution that transferring cold and hot flows that are taken from the heat pump to the related remote departments despite the losses.

Keywords: Heat pump, waste heat recovery, performance test, refrigerator, clothes dryer

ACKNOWLEDGMENTS

I wish to send my deepest appreciation to my supervisor, Prof. Dr. Bora YILDIRIM. This thesis would not be possible without his support and guidance.

I would also like to thank Prof. Dr. Murat KÖKSAL who were abundantly helpful and provided me with the guidance and support. Many thanks also go to other faculty members of the Department of Mechanical Engineering of Hacettepe University.

I especially want to thank my son Mustafa Demir, my sister Rukiye Özlem, my mother Asuman, and my father Turgut KARACAOĞLU, who gave me the joy of living. The last but not the least, I owe my gratitude to my dear wife Selin KARACAOĞLU, who gave me the enthusiasm to study.

TABLE OF CONTENTS

ÖZET	i
ABSTRACT.....	iii
ACKNOWLEDGMENTS	v
TABLE OF CONTENTS	vii
LIST OF FIGURES	ix
LIST OF TABLES	x
1. INTRODUCTION	1
1.1. General.....	1
1.2. Problem Definition	3
2. LITERATURE REVIEW	5
2.1. Literature Survey	5
2.2. Energy Standards for Clothes Dryers	9
2.3. Aims and Objectives.....	9
3. THEORY	11
3.1. Design Background.....	11
3.2. System Components	17
4. METHODOLOGY	29
4.1. General Considerations.....	29
4.2. Experimental Methodology	33
5. RESULTS AND DISCUSSION	35
5.1. Experimental Results	35
5.2. Analytical Validation.....	47
5.3. Cost Analyses	52

6. COMMENTS, CONCLUSIONS, AND FUTURE RECOMMENDATIONS.....	55
6.1. General	55
6.2. Recommendations for Future Work.....	57
7. REFERENCES	59
APPENDICES	63
APPENDIX 1 PROPERTIES OF THERMOMETER.....	63
APPENDIX 2 DETAILED DRAWINGS.....	64
APPENDIX 3 - THE GENERAL VIEW OF THE PRODUCED EXPERIMENTAL SETUP, SENSOR AND DEVICE AND LOAD PLACING	74
APPENDIX 4 – EXPERIMENTAL STEP 5 REFRIGERATOR INSIDE TEMPERATURE AND RELATIVE HUMIDITY VALUES.....	78
APPENDIX 5 - THESIS/DISSERTATION ORIGINALITY REPORT	81
CV	83

LIST OF FIGURES

Figure 3.1. Schematic diagram of reversed Carnot and vapor-compression refrigeration cycles.	12
Figure 3.2. T-s diagram of the ideal vapor-compression refrigeration cycle.	13
Figure 3.3. P-h diagram of the ideal vapor-compression refrigeration cycle.	14
Figure 3.4. T-s diagram of the actual vapor-compression refrigeration cycle.	15
Figure 3.5. P-h diagram of the actual vapor-compression refrigeration cycle.	15
Figure 3.6. P-h diagram of heat pump operating time.	16
Figure 3.7 The drawing of the compressor.	20
Figure 3.8. The frontal view of the compressor.	20
Figure 3.9 Montaged view of the compressor.	21
Figure 3.10 Refrigerator Capillary Tube with Nuts.	22
Figure 3.11. Two different examples of roll bond type evaporator.	24
Figure 3.12. Wire and tube condenser.	24
Figure 3.13. Refrigerator chamber of the designed heat pump system.	25
Figure 3.14 Polyurethane formation stages.	27
Figure 3.15. Polyurethane spray.	27
Figure 4.1. Schematic experimental setup.	29
Figure 4.2. Experimental equipment.	31
Figure 4.3 Designed system view from different aspects.	31
Figure 4.4. System view with fan from above and below positions.	32
Figure 5.1. Drying Rate of All Test Steps.	40
Figure 5.2. Weight change of wet hooded sweatshirt (without wring).	41
Figure 5.3. Variation of inside temperature of the refrigerator with respect to time.	43
Figure 5.4. Variation of inside RH of the refrigerator with respect to time.	44
Figure 5.5. Energy Factors of heat pump used test steps.	45
Figure 5.6. SMER of heat pump used test steps.	46
Figure 5.7. P-h diagram of the first cycle of heat pump system.	46

LIST OF TABLES

Table 2.1 Possible Application of VRF.	8
Table 3.1. Properties of prevalent refrigerants.....	18
Table 4.1 Ambient Conditions	29
Table 5.1 Wet hooded sweatshirt (without wring) after 14:49 time duration.....	35
Table 5.2. Drying cycle of shirts in ambient conditions.. ..	36
Table 5.3. Drying cycle of shirts with fan without the clothes dryer.....	36
Table 5.4. Drying cycle of shirts with clothes dryer without fan.....	37
Table 5.5 Drying cycle of hooded sweatshirts (without wring) with clothes dryer and fan (above).....	38
Table 5.6. Drying cycle of shirts with clothes dryer and fan (above).....	38
Table 5.7 Drying cycle of shirts with clothes dryer and fan (below).....	39
Table 5.8. Drying duration of shirts of all test steps.	40
Table 5.9. Necessary data to calculate EF and EF values.....	44
Table 5.10. Necessary data to calculate SMER and SMER values.....	45
Table 5.11. Heat pump used test steps.	49
Table 5.12. Heat requirements calculated by the first approach	50
Table 5.13. Comparison of heat requirement of the first approach and condenser heating	50
Table 5.14. Mass of vapour and water of different test steps.....	51
Table 5.15. Comparison of heat requirement of the second approach and condenser heating	52
Table 5.16. Price Breakdown Structure of Clothes Dryer Chamber.....	53

DEFINITIONS AND ABBREVIATION

Q	Total Heat Transfer (kJ)
\dot{Q}	Heat Transfer Rate (kW)
P	Pressure (kPa)
T	Temperature (°C or K)
m	Mass (kg)
\dot{m}	Mass flow rate (kg/s)
s	Specific Entropy (kJ/kg.K)
h	Specific Enthalpy (kJ/kg)
c	Specific Heat (J/kg°C)
W	Total Work (kJ)
\dot{W}	Power (kW)
K	Thermal conductivity $W\ m^{-1}\cdot K^{-1}$ or BTU/h.ft.°F
RH	Relative Humidity (ϕ)
R600a	Isobutene ($CH(CH_3)_2CH_3$)
L	Latent Heat (J/g)
ρ	Density (kg/m ³)
V	Volume (m ³)
t	Time (second)
v	Specific volume (m ³ /kg)
SMER	The specific moisture evaporation rate (kg/kWh)
DR	Drying Rate (g/h)
EF	Energy Factor (kg/kWh)
VRF	Variable Refrigerant Flow
VRV	Variable Refrigerant Volume

HVAC	Heating, ventilation, and air conditioning
$u_{g@^{\circ}\text{C}}$	Internal energy of saturated vapour (kJ/kg)
TL	Turkish Lira
\$	US Dollar (USD)

1. INTRODUCTION

1.1. General

Today, the use of electric energy efficiency becomes important from the perspective of economic and natural resources. The number of consumers of electrical energy is very high, so a small amount of electricity consumption savings significantly reduce the production costs and the number of resources that are consumed in order to obtain electrical energy.

Energy and material prices are increasing day by day, and accessing energy and materials is constantly getting harder. This situation necessitates efficient designs with a priority on energy and material saving.

Heating and cooling are one of the major energy-consuming processes in modern life. However, the use of heat pumps for heating and cooling processes can offer efficient solutions. For example: instead of creating heat using electricity or gas, heating water by transporting heat from a source with heat pumps can be 2 or 3 times more efficient than traditional systems (Commercial HPWH, 2000).

In this thesis, it is aimed to both dry clothes and cool food in the same system with the dual use of a heat pump in order to reduce environmental pollution, which affects human life more and more every day, and to prevent the waste of limited natural resources. In addition, the use of dual-use heat pump systems with very high efficiency will be expanded, with the foresight that energy-efficient systems will dominate all sectors due to the decreasing energy resources.

Today, there are refrigerators and clothes dryers that work with heat pumps. There are also heat recovery applications that use waste heat. However, examples of both refrigerator and clothes dryer in the same cycle have not been found in the literature. In this thesis, both heating and cooling functions are used in a single heat pump cycle. The waste heat drawn from the environment in order to obtain a refrigerator chamber will be used for clothes drying. Thus, the need for equipment and energy for drying laundry will be eliminated as much as possible, while providing food cooling. In other words, thanks to the designed system, there is no need for a second heat pump mechanism to dry clothes. Only a fan may be needed to allow the air heated by the waste heat drawn

from the cooling chamber to pass through the laundry to dry, and an isolated chamber to hold the laundry is needed. However, additional humidity and temperature sensors and a scale are used for the experimental setup to measure the efficiency and effectuality of the system. Versions for conventional use, that may be developed in the future, will not need these sensors. It is considered that such a system will create great savings in businesses, especially in the service sector such as hotels, restaurants, and hospitals, where energy consumption and equipment costs are extremely high. Moreover, the heat obtained in the system can be used for timber, fruit, vegetable drying, or dehumidification machines.

In this study, thermodynamic analysis and design of a dual-purpose heat pump that transforms waste heat into useful heat are done. The reliability and efficiency of the prototype were evaluated, and the effectiveness of the system was examined. In the second part of the thesis, previous studies that shed light on the prototype design are explained. In the third chapter, the working principles of air source heat pumps and thermodynamic analysis are done. Prototype components are introduced, and their selection is explained. In the fourth chapter, general considerations and the experimental methodology are presented. In the fifth chapter, test results are shown, and analytical validation of the system is checked. In addition, cost analyses are performed. In the last section, obtained data are interpreted, and suggestions for future studies are given.

1.2. Problem Definition

In the current design of domestic refrigerators, the absorbed heat is directly wasted. On the other hand, domestic clothes dryers consume high energy during the drying process even though their design is based on a heat pump cycle. Therefore, in order to make an energy efficient system, energy consumption to heat the air inside the clothes dryer has to be decreased with the help of a refrigerator.

This thesis attempts to develop a dual purpose heat pump that transforms waste heat into useful heat. An experimental design is developed and built to analyse the refrigerator and clothes dryer chamber. Moreover, in this thesis, it is endeavoured to find the drying effect of fan power in the heat pump system, the volume of the refrigerator chamber, its heat load, and the viability of dual purpose heat pump for small applications. For this purpose, several steps are determined for experiments.

Finally, energy savings and efficiency are calculated by using both refrigerator and clothes dryer functions at the same time.

2. LITERATURE REVIEW

2.1. Literature Survey

According to the Turkish Dictionary of Science Terms, cooling is the extraction of heat from a system, an object, or an environment using various methods to lower the temperature. Cooling is a thermal process that has great importance in food preservation and ambient air conditioning.

In 1775, the production of ice, using an air pump by William Cullen, was the first work in the literature to achieve mechanical cooling. The first patent for mechanical refrigeration was obtained by Thomas Harris and John Long in 1790. Engineer Jacob Perkins built the first reliable refrigeration machine in 1834. A medical doctor named John Gorrie was the first to build a commercial refrigeration machine in 1844 (Lawrance, 2003).

With the widespread use of electricity, William F. Singer (1897) patented the first automatic, electric sourced small-size refrigerator unit in New York. As a result of the developments in plastic and insulation material production techniques, refrigerator design and structures have become sophisticated, and the usable storage volume of the refrigerator has increased. In addition, refrigerator design gained momentum with the use of halogen coolers (Radermacher et al., 1996).

Doctor James Harrison used sulfuric ether as a refrigerant (the circulating fluid in the system) in 1860. Fluorocarbon refrigerants were mentioned for the first time by Midgley and Henne (1930), and the first commercial refrigerant, dichlorodifluoromethane (R12), was introduced in 1931. The use of R12 has reduced the use of sulphur dioxide (R764), methyl chloride (R40), and methyl formate (R611), all of which were poisonous, and used by previous manufacturers.

Previously, clogging of the capillary tube was a challenge. However, the use of physically safe, oil-soluble, halogenated hydrocarbons as working fluids has increased the use of capillary pipes in the system (Karmazin, 1940, Stabler, 1942).

Today's usual refrigerators, which have two parts a cooler and a freezer, were invented in 1939 and their widespread use begins in the post-World War II period (Roider et al., 1948). Although there are many different designs these days, refrigerators for home use basically have the same technology.

There are four main methods to increase the efficiency of refrigerators which are improving the efficiency of the cooling cycle, reducing the cabinet heat load, reducing parasitic electrical loads, and reducing on/off loop losses. However, each improvement creates a disadvantage in terms of cost increase and the complexity/reliability of the system (Turiel, 1988, Granryd, 1992).

In 1852, Lord Kelvin showed that refrigeration machines could be used for heating as well as cooling. (Schaefer, 2000). Haldane (1938) examined experimental data from a refrigeration plant from 1891 to 1926 to demonstrate the heating efficiency of heat pumps. He also installed an experimental heat pump in his house and tested different heat sources.

As a result of global ecological problems and the energy crisis, the use of heat pumps in domestic, commercial, and industrial heating has increased. Due to the energy efficiency and environmental benefits of heat pumps, they have been becoming more popular as a heating solution in various sectors. Today, governments and organizations worldwide are promoting to use renewable energy sources and energy efficient devices. Heat pumps align with these goals since they use low-grade heat sources and consume less energy than traditional heating methods. For example, Kütük (2019) integrates a heat pump into a dishwasher and saves 302 Wh in energy consumption.

According to the Turkish Dictionary of Science Terms, drying in its broadest sense is the removal of water or other volatile liquids from a liquid or solid by natural or artificial methods using energy. Drying methods can be listed as natural drying in the sun/outdoor; drying with hot air, drying by cooling; vacuum drying, and drying with the help of chemical substances (Doğan, 1999).

Patent applications for the heat pump drying method started in 1973 and the first studies in the literature were made by Hodgett and Geeraert. Hodgett (1976) found that the energy consumption of heat pump dryers is less than conventionally used steam-heated dryers. Geeraert (1976) worked on the heat pump timber dryer.

71% of homes in the USA have a clothes dryer, which corresponds to 81 million households. In 2017, 4% of the energy used in homes was spent on clothes drying (Gluesenkamp et al., 2019). Three different types of clothes dryers have been found in the literature. These are vent dryer, condensing dryer, and heat pump dryer. In addition, the latest product named “air dresser” was introduced by a company serving in the field

of user electronics. It works with the principle of a heat pump, does not have a drum, and is used by hanging clothes with a hanger inside. It is claimed that the product deodorizes, gives a feeling of freshness to the clothes, and allows the clothes to be dried sensitively at low temperatures and ironed in a shorter time with fewer wrinkles (Samsung, 2023). In light of this information, it is evaluated that the sector is open to progress in this direction.

In order to have sustainable energy, three important technological developments are needed. These are the demand for energy savings, efficiency in energy production, and the replacement of fossil fuels with various renewable energy sources. In this context, heat pump drying systems increase energy efficiency and consume less fossil fuel than other methods (Çolak et al., 2009).

Heat recovery in a heat pump system refers to the utilization of waste heat generated during the cooling or heating process. It improves the overall energy efficiency of the system by extracting additional thermal energy that would otherwise be wasted. Implementing heat recovery techniques can increase energy efficiency and reduce the operating costs of heating and cooling processes.

Variable Refrigerant Flow (VRF) heat pump systems are highly efficient heating and cooling systems that use a single outdoor unit connected to multiple indoor units. They are also known as Variable Refrigerant Volume (VRV) Heating, ventilation, and air conditioning (HVAC) systems which is a brand name of Daikin. VRF systems allow for individual control of temperature and airflow in each zone or room. This provides personalized comfort and flexibility, as different areas can be set to different temperatures based on occupants' preferences. VRF heat pump systems are designed for high energy efficiency. They achieve this through variable speed compressors and inverter technology, which adjust the refrigerant flow rate and compressor speed based on the heating or cooling demand. This results in precise temperature control and reduced energy consumption. VRF systems have the ability to provide simultaneous heating and cooling in different zones within the same building. Heat recovery technology allows excess heat from areas requiring cooling to be redirected and used for areas requiring heating. This improves overall system efficiency and reduces energy waste. Compared to traditional HVAC systems, VRF heat pump systems require smaller ductwork and offer more flexible installation options, resulting in potential space

savings in buildings. Table 2.1 shows the energy savings potential of VRF systems, and the initial cost (Thornton et al., 2012).

Table 2.1: Possible Application of VRF

Property	Value
Building area affected, cumulative for five years of projects	1 million ft ²
Total initial cost at \$24/ft ²	\$24 million
Incremental initial cost \$3.00/ ft ²	\$3 million
Annual energy cost savings potential at \$0.29/ ft ²	\$290,000/year
Simple payback	10 years

Although Table 2.1 states simple payback is 10 years, according to a 30-year analysis executed by Fuller (1995). VRF is more expensive than variable air volume up-front and in maintenance repair and replacement. However, VRF can still have a lower life-cycle cost because of energy cost savings.

Zajac (2019) studies waste heat recovery from a refrigeration system. The application models approximately 1000 m² commercial facility that has hot and cold areas with 700 m² and 380 m² area respectively. According to Mahlia (2010), heat recovery is possible from an engine, domestic water cooled air conditioner, textile drying and they produced a room air conditioner dryer (RACD). RACD works at the ambient temperature that is between 26,9°C and 27,5°C ambient conditions and it is found that if RACD works for 25°C room air, it can remove 875 g moisture in 70 min. with 843 W power consumption. However, RACD system has a fan with 25 W and there is no fan closed or position change case in the experiment. The size and heat load of the air-conditioned room and the maximum temperature of the clothes chamber is not known. The capacity of the heat pump system is bigger than a usual domestic refrigerator. In addition, it is thought that heat wasted from a refrigerator has not been transformed into useful heat yet in the literature.

2.2. Energy Standards for Clothes Dryers

Drying performance can be determined by an energy factor (EF) which is the ratio of the weight of dry clothes to the energy consumed to dry them. The minimum EF of an electric dryer by the 2015 DOE minimum efficiency standard is 1,69 kg/kWh (Shen et al., 2016).

In addition, the moisture removed per unit of energy consumption (SMER) is a specific factor to indicate the efficiency of the dryer (Mahlia, 2016).

2.3. Aims and Objectives

In this thesis, it is aimed to both dry clothes and cool food in the same system with the dual use of a heat pump in order to reduce environmental pollution, which affects human life more and more every day, and to prevent the waste of limited natural resources. In addition, the use of dual-use heat pump systems with very high efficiency will be expanded, with the foresight that energy-efficient systems will dominate all sectors due to the decreasing energy resources.

For these purposes, several test steps are performed to see whether this kind of heat pump system is viable or not. Energy consumption and efficiency of the system as a clothes dryer are compared with energy standards of conventional clothes dryer data. Acceptability of the duration of the drying process and the amount of clothes are investigated for a small household refrigerator application. The validity check of the experimental setup is performed analytically in rough order magnitude level. Moreover, cost analyses and savings are studied.

3. THEORY

3.1. Design Background

A heat pump withdraws heat from a source and transfers it to another source by doing some work on the system. Normally, the heat spreads from high temperature to low temperature due to its nature. Heat pumps can perform this flow in the opposite direction via a small amount of energy input. If the system is used for cooling, the name of the mechanism will be the cooling machine. Also, if the system is used for heating purposes, the name of the mechanism will be a heat pump.

Generally, there are two types of heat pumps regarding their cycle which are vapour compression and absorption. One of the most important elements that is affecting the design of heat pumps is the source of energy. Water, soil (geothermal), and air (air to air) can be used as the energy source of the system. The most widely used energy source is ambient air because air to air systems have a simple design compared to others.

A heat pump is composed of main four units which are the compressor, evaporator, condenser, and expansion valve. In addition, there are some system control units such as pressure and temperature indicator exist in some heat pumps.

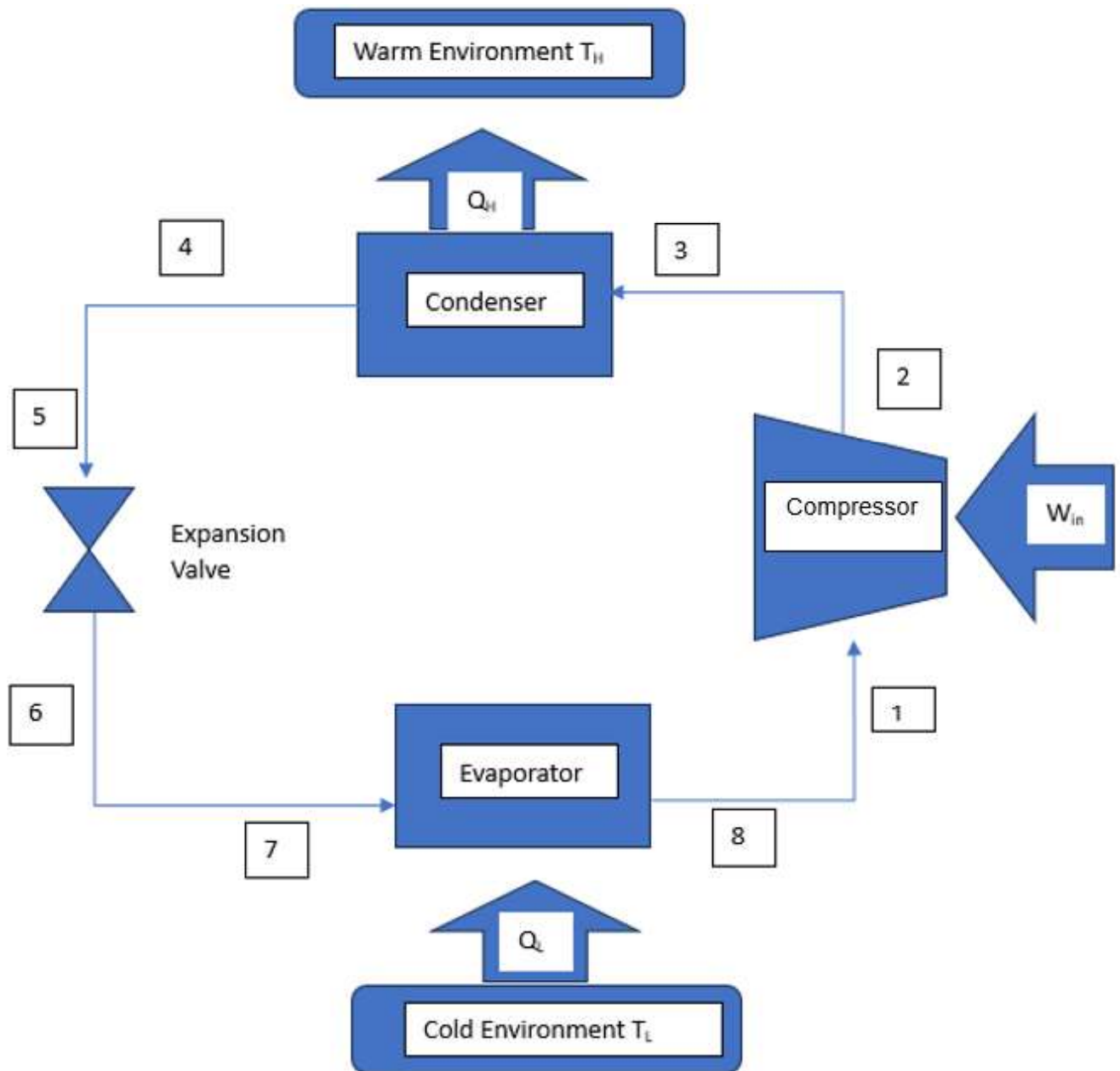

Figure 3.1. Schematic diagram of reversed Carnot and vapor-compression refrigeration cycles (Çengel et al., 2006)

Figure 3.1 is the schematic diagram of reversed Carnot and vapor-compression refrigeration cycles. The reversed Carnot cycle is the ideal heat pump cycle that works between T_L and T_H temperatures (Çengel et al., 2006). The arrow direction is accepted as positive in Figure 3.1.

The cycle consists of the following four processes in series:

1st to 2nd: Isentropic compression of the refrigerant occurs in the compressor by supplying work, W_{in} . Refrigerant pressure and temperature increase.

3rd to 4th: Refrigerant rejects heat isothermally to high temperature reservoir at T_H with an amount of Q_H . Thus, fluid changes its state from saturated vapor to saturated liquid.

5th to 6th: The gas expands adiabatically.

7th to 8th: Refrigerant absorbs heat isothermally from low temperature source at T_L with an amount of Q_L .

Ideally, in states 2-3, 4-5, 6-7, and 8-1, there are no changes occurred. The reversed Carnot cycle is not applicable to an actual heat pump. The reason is the 1st to 2nd stage contains the compression of a liquid-vapor mixture, which requires a compressor that will handle two phases, and the 5th to 6th stage contains the expansion of high moisture content refrigerant.

The ideal vapor compression refrigerator cycle is an ideal model for heat pumps. Unlike the reversed Carnot cycle, the fluid is vaporized completely before it is compressed, and the turbine is replaced with a throttling device (Çengel et al., 2006). T-s and P-h diagrams of the ideal vapor compression refrigerator cycle are given in Figures 3.2 and 3.3 respectively.

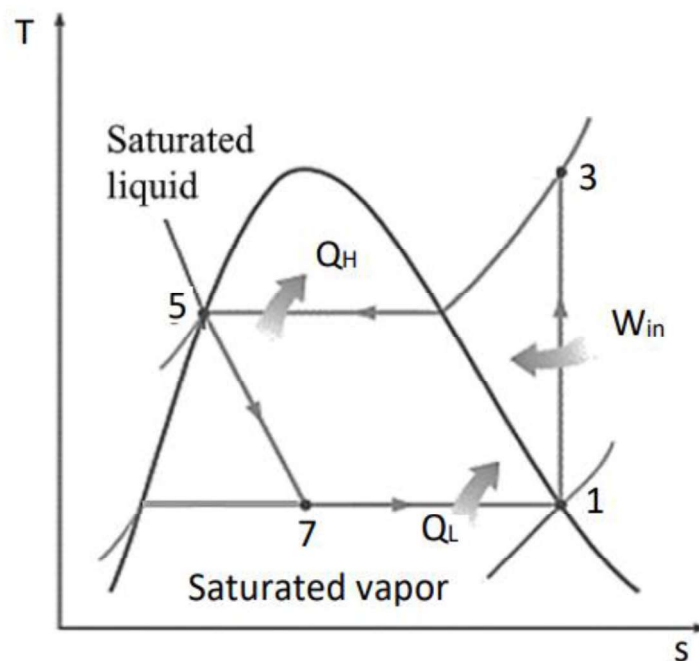

Figure 3.2. T-s diagram of the ideal vapor-compression refrigeration cycle (Çengel et al., 2006)

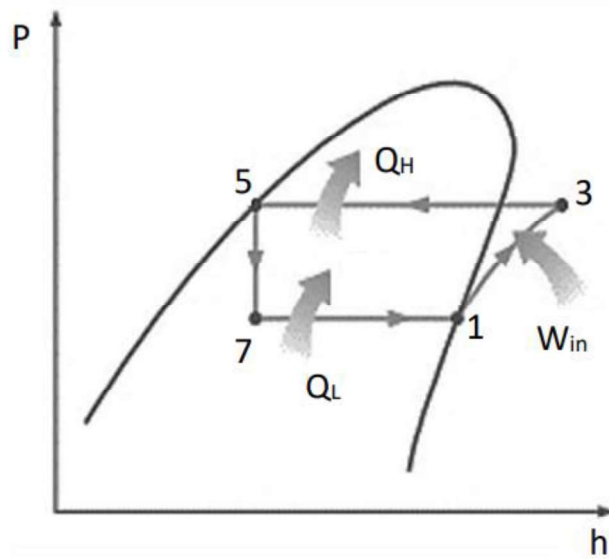

Figure 3.3. P-h diagram of the ideal vapor-compression refrigeration cycle (Çengel et al., 2006)

In an ideal cycle, isentropic compression in the compressor (1st to 2nd), constant pressure heat rejection in the condenser (3rd to 4th), irreversible throttling in the expansion valve (5th to 6th), and constant pressure heat absorption in the evaporator (7th to 8th) occur. However, the temperature and volume of the vapor do not vary exactly ideal because the refrigerant vapor is not a perfect gas (Dossat, 2010). The deviations between an actual vapor compression refrigeration cycle and an ideal one are primarily due to irreversible processes that take place in different components. These irreversibilities mainly arise from fluid friction, which leads to pressure drops, as well as heat transfer between the system and surroundings (Çengel et al., 2006).

T-s and P-h diagrams of the actual vapor compression refrigerator cycle are given in Figures 3.4 and 3.5 respectively.

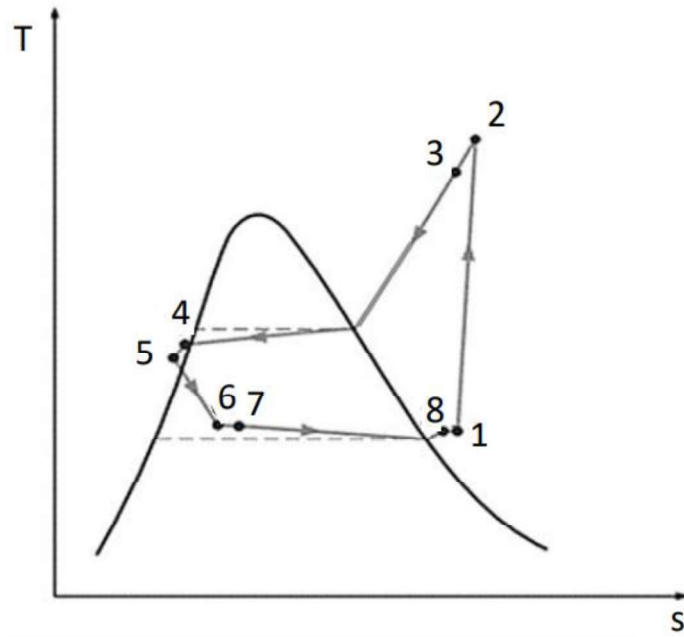

Figure 3.4. T-s diagram of the actual vapor-compression refrigeration cycle (Çengel et al., 2006)

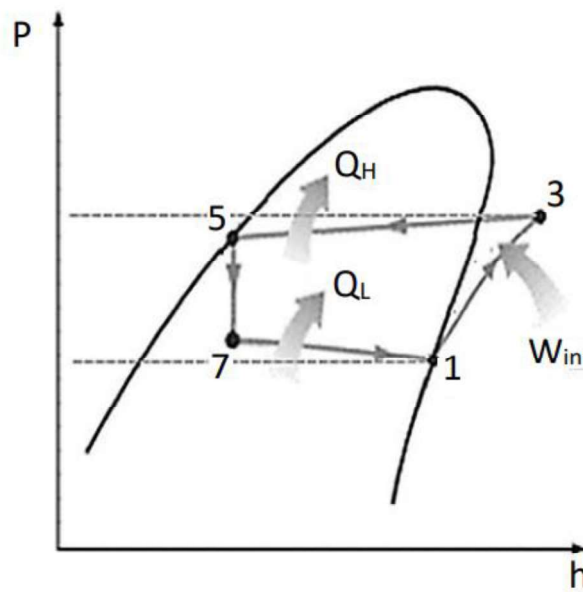

Figure 3.5. P-h diagram of the actual vapor-compression refrigeration cycle (Çengel et al., 2006)

The differences between an actual vapor compression cycle and an ideal one are as follows:

1. The compression process in the compressor is non-isentropic.

2. The refrigerant exits the evaporator in the superheated vapor state.
3. The refrigerant exits the condenser as a subcooled liquid.
4. Pressure drops occur in both the condenser and the evaporator.

For the actual cycle, the p-h diagram dynamically shifts upwards while the compressor is running. In other words, the temperatures are constantly increasing. Therefore, calculations can be done at certain intervals by accepting each cycle as instantaneously ideal (Kütük, 2019). Then these calculations can be integrated using the forward Euler method. An example of the actual cycle behavior and corresponding states 1,3,5 and 7 are shown within 20 min intervals in Figure 3.6.

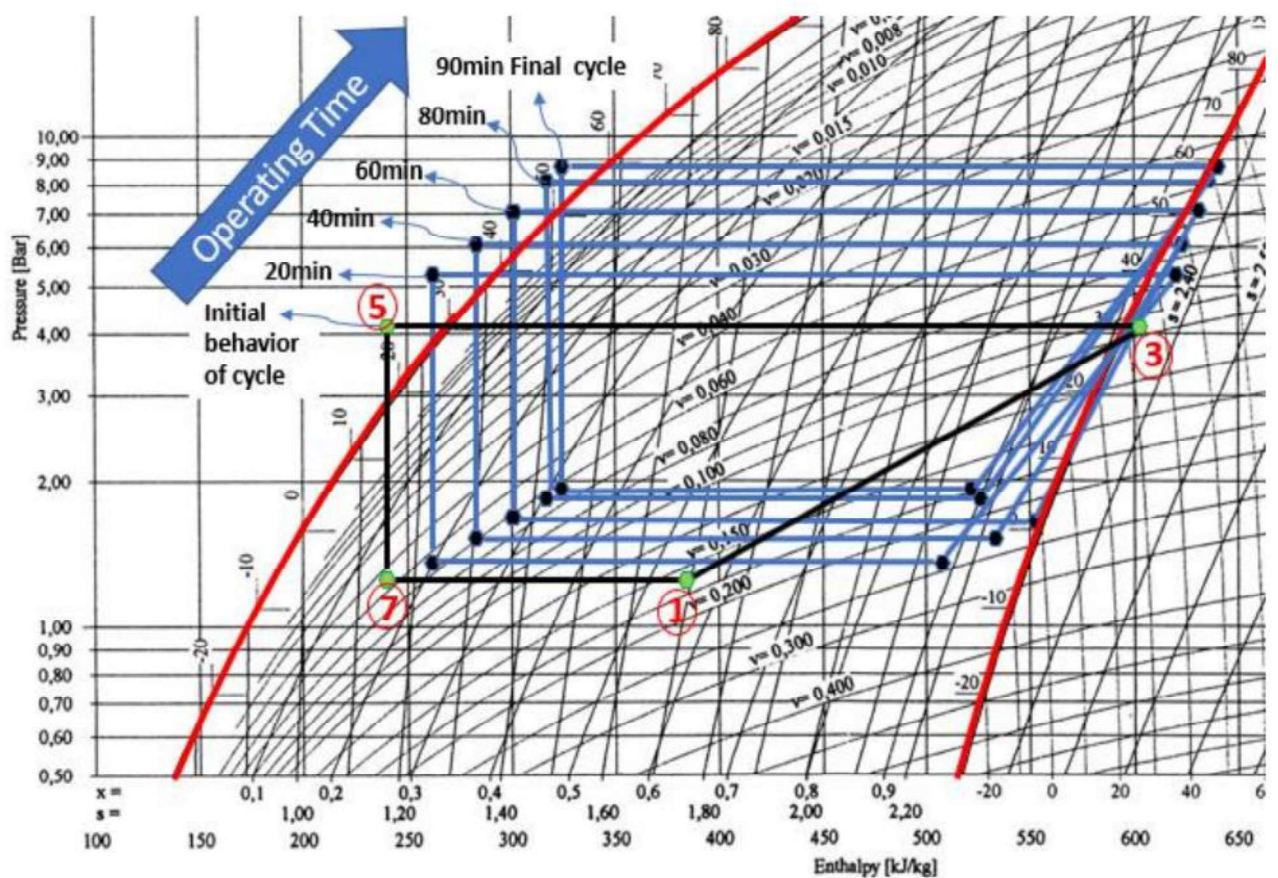

Figure 3.6. P-h diagram of heat pump operating time (Kütük, 2019)

As shown in Figure 3.6, after the heat pump cycle starts, condensation and evaporation temperatures and pressures are increasing over time.

3.2. System Components

Refrigerant

The refrigerant fluid circulates in the heat pump, evaporates in the evaporator, and condenses in the condenser. In this way, it takes the heat from the low temperature source and transfers the heat to the high temperature source. In other words, the refrigerant fluid that is used in the design, draws heat from the refrigerator chamber and transfers this heat to the clothes dryer chamber. In order to perform this task, the refrigerant must have some basic properties. According to the United States Environmental Protection Agency (EPA, 2023), refrigerant should be completely stable in the system and should be able to decompose rapidly in the atmosphere. If it leaks into the atmosphere, its impact on the environment should be minimal. Moreover, it should not be flammable or poisonous. Critical and boiling temperatures should be suitable for the system in which it is used. High volumetric heat absorbing capacity and high oil solubility properties are preferred.

The characteristics of the fluid to be used in vapour compression heat pumps are easy to find and cheap, being inert and durable under system conditions, non-toxic, non-explosive, non-corrosive to metal, not have a bad smell, in case of leakage it should be determinable. The last but not the least, refrigerant fluid, which operates between the condenser and evaporator temperatures, must be thermodynamically suitable. It means that refrigerant must have a low boiling point, significantly high critical temperature, high latent heat of vaporisation, the low specific heat of the liquid, a low specific volume of vapour, and must require low-cost compressors.

Bauer (2015) states that halocarbons are refrigerants that are used as working fluids for the transportation of thermal energy. They contain carbon and either chlorine, fluorine, bromine, or iodine. There are 3 main types of halocarbon refrigerant fluid which are chlorofluorocarbon (CFC), hydrochlorofluorocarbon (HCFC) and hydrofluorocarbon (HFC). However, governments under the United Nations' Framework Convention on Climate Change (FCCC) committed to decrease emissions to the atmosphere of greenhouse gases. For example, R-12 (CFC) was very common, but its usage ended in the mid-1990s. Since 1994, the most popular one is R-134a (HFC). On the other hand, FCCC conference, held in 1997 (Kyoto Protocol), it is decided that the emission of HFC refrigerants to be reduced (Johnson, 1998). After that, car producer companies start to

change the types of refrigerants of air conditioners in 2012 with new types that are more climate friendly. A July 2015 rulemaking (Significant New Alternatives Policy – SNAP Regulations) forced the manufacturer to not use R-134a by the model year 2021. It is a good example to show that R134a is banned very soon all around the world because of environmental concerns. Apart from halocarbon working fluids, heat pump systems can also be operated with non-halocarbon fluids such as carbon dioxide and hydrocarbons.

Hydrocarbons are heavily used in refrigeration industries. They have climate-friendly characteristics and low charge amounts. Nevertheless, there is a flammability and explosion risk in domestic refrigerators. Although, the normal use of isobutene (R600a) in refrigerators had not caused any accidents yet (Wennerstrom, 2007), usage of isobutane in North America is not widespread considering wide usage in the domestic sector in Europe (Joybari et al., 2013). Also, Joybari listed the properties of prevalent refrigerants as follows:

Table 3.1. Properties of prevalent refrigerants

Refrigerant	IUPAC (International Union of Pure and Applied Chemistry) Name	Chemical Formula	Molecular Weight	Atmospheric Life (year)	Ozone depletion potential	Global warming potential
R12	Dichlorodifluoromethane	CCl_2F_2	120,9	100	1,0	10900
R22	Chlorodifluoromethane	CHClF_2	86,5	12	0,05	1810
R134a	1,1,1,2-Tetrafluoroethane	$\text{C}_2\text{H}_2\text{F}_4$	102,0	14	0	1430
R600a	Isobutene	$\text{CH}(\text{CH}_3)_2\text{CH}_3$	58,1	12	0	<20

The properties of common refrigerant fluids are represented in Table 3.1. As can be seen, the global warming potential of R600a is very low.

In this design, R600a is used as a working refrigerant fluid because, it is more environment friendly. Its flammability can be neglected since it is used in a control volume and experimental conditions. In addition, domestic type refrigerator producers mainly use R600a in this day.

Compressor

The compressor is a very important mechanical device that creates the circulation of refrigerant fluid through the condenser and evaporator coils. Thus, the heat inside the refrigerator chamber is removed. The compressor is responsible for compressing the refrigerant fluid from low pressure to high pressure in order to enable it to flow through the heat pump cycle.

There are a lot of factors to consider when choosing a compressor for a heat pump system. The first factor is the type of refrigerant. According to evaporation and condensation temperatures, the required cooling and heating capacity should be determined under standard operating conditions. All refrigerants have different properties and need different compressors to operate efficiently. A determined pressure inside the evaporator corresponds to a determined temperature, depending on the refrigerant fluid. For low temperatures, the fluid density is high, so there is a small amount of extraction during evaporation. If evaporation takes place at high temperatures, the pressure and density increase, and more heat can be drawn. As a result of that, the power required by the compressor at high evaporation temperature is greater than the case at low evaporation temperature. Thus, compressors with higher operating torque should be used in systems with higher evaporation pressure. Compressors can be classified concerning their evaporation temperatures in the industry which are given below (Kaeltechnikshop, 2023). High Back Pressure (HBP): High evaporation temperature (between -5 °C and + 15 °C)

Medium Back Pressure (MBP): Medium evaporation temperature (between -35 °C and - 5 °C)

Low Back Pressure (LBP): Low evaporation temperature (between -35 °C and +10 °C)

As can be seen above, there are three new factors are described which are capacity, efficiency, and operating conditions. The second factor that is explained is the capacity of the compressor which should be matched to the cooling load requirements. If a compressor with insufficient capacity is used, the system cannot provide adequate cooling. On the other hand, if a compressor with excessive capacity is used, it will result in inefficient operation. The third factor is the efficiency of the compressor. The energy efficiency of a compressor is very important for a heat pump system because, it has a significant impact on running costs. Another factor is operating conditions which include ambient temperature, humidity, and altitude. The fifth factor is related to life

time cost which is reliability. The compressor should have a long life, high mean time between failure rate, reduced downtime, and low maintenance costs Noise level of the compressor is also an important factor since the heat pumps are usually used indoor applications.

In conclusion, these factors should be carefully considered when selecting a compressor for a heat pump system. The compressor that is used in the system is PZ59E1C and its producer is GMCC.

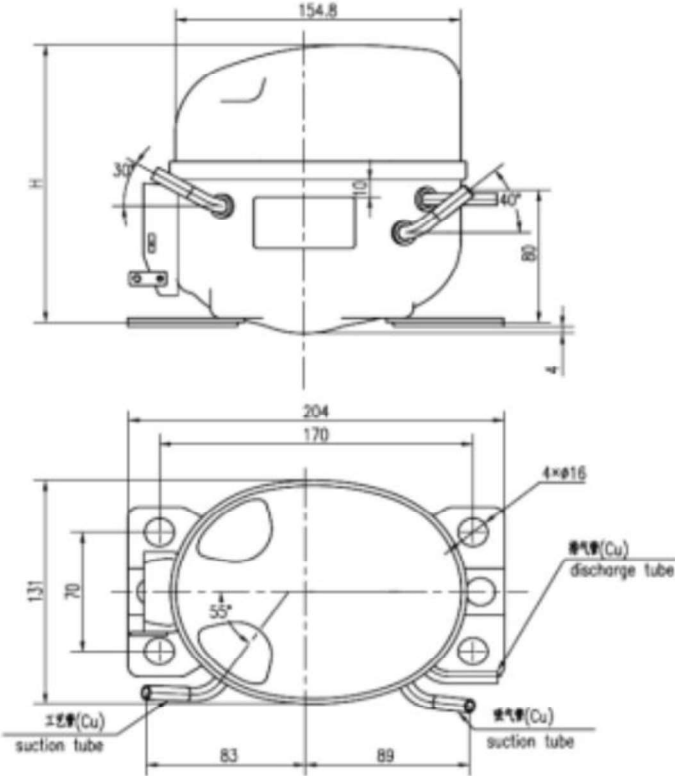

Figure 3.7 The drawing of the compressor

It is a hermetic type reciprocating compressor. The drawing of the compressor is included in Figure 3.7.



Figure 3.8. The frontal view of the compressor

The frontal view of it is shown in Figure 3.8 and the installed view is shown in Figure 3.9.



Figure 3.9 Montaged view of the compressor

The red perpendicular in Figure 3.9. indicates the location of the compressor on the cycle. As shown in the figure, it is located below.

Expansion Valve

The expansion valve is an essential component of a heat pump system. It controls the mass flow rate of refrigerant between the condenser and the evaporator. The pressure drop occurring in the expansion valve divides the heat pump system into two as high

pressure side and low pressure side. : The expansion valve works based on the principle of thermal expansion. As the high-pressure refrigerant enters the valve, its pressure and temperature drop. This phenomenon causes the refrigerant to expand and change its phase from liquid to gas. Some duties of the expansion valve in a heat pump system are regulation of pressure, and flow control. In addition, different refrigerants have different properties, and the valve should be chosen to work with a specific refrigerant.

There are three main types of expansion valve commonly used in the industry which are capillary tube, automatic expansion, and thermostatic expansion valve. The thermostatic expansion valve controls the flow by adjusting mechanically. The mechanism basically regulates the flow according to the amount of superheated steam. In this way, it adjusts the system regardless of operating conditions.

The automatic expansion valve is a mechanical adjustment control device that keeps the flow at a constant pressure in the evaporator. It consists of a needle, a spring that is attached to a controller screw, and a diaphragm.



Figure 3.10 Refrigerator Capillary Tube with Nuts

Figure 3.10 shows an example of a capillary tube expansion valve. The capillary tube is the simplest designed control instrument among others. It consists of a fixed length and small diameter copper tube as seen in Figure 3.10. Also, it is the cheapest expansion valve mechanism. Due to the fact that the capillary tube is very thin, the pressure difference can be kept constant. According to Ankara University lecture notes (2023) if the pressure decreases below normal in the evaporator, the flow through the capillary tube accelerates and the pressure reaches the normal value. If the evaporator pressure

increases above the normal, the flow rate through the capillary tube automatically deaccelerates the pressure and takes the normal value again. In heat pump systems, a collector tank is used with this capillary tube for adaptation to the operating conditions. The location of the capillary tube is between the condenser and the evaporator which has a diameter between 0.76-2.16 mm (Aslan,2007). If the heat pump system is small, operates between certain temperature values, and has on-off control, capillary tubes should be preferred. For example, the refrigerator stops and runs very often to keep inside between certain temperatures. The capillary tube balances inlet and outlet pressures very quickly. Therefore, the compressor does not have to overcome the back pressure when it starts again. However, in large systems, this mechanism is not recommended because it is not able to respond to capacity change since it provides the same fluid flow in all cases (MEB, 2014). For these reasons, the capillary tube is evaluated as optimal for the system.

Evaporator

Evaporators are heat exchanger components that allow the refrigerant to absorb heat from the surroundings or items. In the industrial application and domestic product sector, there are a lot of different evaporator designs in many different sizes and mechanisms. The variation is caused by types of refrigerant, types of expansion valve, operating conditions, and the purpose of application. However, one thing is the same almost for all evaporators which is the material to be produced. Since the evaporator is generally located in the room (where people live in) to be cooled or in environments that have direct or indirect contact with foodstuffs (naturally important for human health), they are made of aluminium and copper materials because these elements are corrosion resistant. Moreover, metals have great thermal conductivity levels. Aluminium and copper are the most thermal conductors which have 223 and 118 BTU/h.ft.°F (385 and 204 W/m·K) thermal conductivity coefficients respectively.

The choice of the evaporator type and shape strongly depend on heating/cooling requirements, environmental conditions, and montage space. There are three main evaporator shapes that are described as follows. Plate evaporators are used in both air and ground source heat pumps. Shell and tube evaporators are generally used for water source heat pumps. Finned evaporators are used for air source type heat pumps.

As the refrigerant absorbs heat, the evaporator contains the water particles in the air condense. In some applications, this liquid water is removed by a drain. The maintenance of the evaporator is as important as the maintenance of the other components of the heat pump system to have an efficient operation. Heat pump systems, which can cool at 5 °C and below, may have different features in order to defrost the surface. This design has a roll bond (a kind of plate shape) type evaporator and has no defrosting feature.



Figure 3.11. Two different examples of roll bond type evaporator.

Figure 3.11 monitors how roll bond type evaporators are looking. In this design, the evaporator is inside the freezer compartment of the refrigerator chamber.

Condenser

The condenser is the main component that transfers heat from the environment to be cooled to the environment to be heated. This heat is absorbed from the refrigerant which was heated before by the compressor and evaporator in the heat pump cycle. Thus, condensers should be chosen with a capacity that is larger than the capacity of evaporators (approximately 20% is enough), since they are not responsible not only to remove the heat drawn by the evaporator but also the heat loaded by the compressor.



Figure 3.12. Wire and tube condenser

Wire and tube type condensers are preferred in domestic refrigerators and especially in single-door refrigerators. Tube-fin type air cooled condensers are produced in the industry. In the designed system, wire and tube type condenser as shown in Figure 3.12 is used.

Refrigerator Chamber

A conventional refrigerator has two main compartments which are freezer and cooler. Depending on their intended purpose, refrigerators may have different types and sizes. The refrigerator chamber of this design can be considered as a single-door refrigerator. There is a freezer compartment above the cooler compartment and there is an inside door for the freezer compartment as seen in Figure 3.13



Figure 3.13. Refrigerator chamber of the designed heat pump (Regal, 2023)

A lot of different materials are used according to the structure and purpose of use of the refrigerator chamber. Since one of the heat transfer modes is radiation, the outer surface of the refrigerator chamber of this design is bright and has white colour in order to minimize the heating effect of radiation. Moreover, the insulation of the cooler chamber must be very good in order to keep the indoor temperatures of the refrigerator chamber low. Since the outer structure of the refrigerator chamber is mostly made of metal material, which conducts heat well, additional insulation requirement is inevitable. The amount of insulation and heat passed per unit time are taken into account in the calculation of installation and operation (tests) of the refrigerator chamber. Refrigerator chamber walls, roof, and floor are insulated with 30 mm polyurethane with $0.03 \text{ W m}^{-1} \cdot \text{K}^{-1}$ thermal conductivity. The overall coefficient of heat transmission U is found as $0,765 \text{ W/m}^2\text{K}$ by interpolation with respect to Dossat's (2010) related tables. The theoretical calculations related to this are carried out in the next chapters. However, thermal insulation is not limited to the body and covers. Special wicks and gaskets, which are used to prevent air leakage from the door opening, are insulating materials. For theoretical calculations and experiments, the door is kept closed, so there is no need to assume any additional leakage caused by the door opening. Despite careful attention to dimensions and construction techniques, small gaps and holes are occurred because of manufacturing. Filling materials such as silicone are used to protect heat gain through air leakage from these gaps.

Coating, painting, and cathodic protection methods are used to protect the refrigerator chamber structure against corrosion.

Clothes Dryer Chamber

The heat energy flows from the hot medium to the cold. The purpose of the clothes dryer chamber is to keep the temperature of the room containing the clothes at a value above the ambient temperature with the help of the heat energy that is absorbed from the refrigerator chamber. Heat flow always occurs from the heated clothes dryer chamber to the colder surrounding. It is not possible to completely prevent heat transfer, but heat transfer can be reduced and slowed down. The conduction is related to the molecular structure of materials and each material has a different ability for conduction. Insulators are materials that transfer a small amount of heat per unit of time. The most important issue when choosing insulation material is the thermal conductivity coefficient of the material, cost of the material, and practicableness of application.

Moreover, in this design, there are a large number of water droplets in the clothes dryer chamber. In this situation, non-waterproof insulation material loses its properties very quickly. Thus, the insulation material should not be affected by humidity, and it should contain water inside. Polyurethane and Styrofoam are commonly used for heat insulation. Styrofoam is produced by fusing the inflating polystyrene particles via a molding process. Expanded polystyrene (EPS) is a thermoplastic that is white coloured thermal insulation material. Styrofoam is generally used as an insulation material in building walls. It is preferred because, it is easy to apply and cheap.

Polyurethane foams or polyurethane based products consist of two main materials which are catalysis that chemically reacts them and chemical additives that cause them to swell (foam). As seen in Figure 3.14, the formation phases of polyurethane begin with the interaction of the substances. When the chemical mixture reacts, a cream-like formation is observed at the very beginning of the reaction. After that, the foam begins to rise and expand. The time elapsed between the start of the rise and its stop is called the gelling time (also called rise or spin time). If the foam is touched as soon as the foam stops rising, it sticks to the hand or touched object. After a while, the foam does not stick to any object.



Figure 3.14 Polyurethane formation stages

The polyurethane hardens and firmly fills the container it is in. It acts both as an insulation and structural support in the clothes dryer chamber due to its hardness and solidification as a filler.



Figure 3.15. Polyurethane spray

Polyurethane foams are sold as sprays in the market. The applied product is given in Figure 3.15. A cost comparison should be executed to use it for insulation purposes.

Polyurethane is hazardous to health during chemical reactions. Direct contact, smelling, or ingestion in any way can have very dangerous consequences. For the application, the necessary precautions are taken.

Polyurethane is chosen as the insulation material because it is more advantageous the penetration and durability. In addition, the fact that it fills the volume it is in without leaving any gaps makes it superior to Styrofoam for insulation.

The application requires experience and mastery. Thus, it is hard to have desired thickness for all surfaces. Polyurethane layer thicknesses are chosen as the optimum value considering refrigerator chamber dimensions, insulation requirements, and cost management. The polyurethane fills the gap between two wooden surfaces which are prepared before. Due to the polyurethane swelling and elasticity of the wall, there is a curved surface on the right wall. The maximum thickness is 10% higher than normal but there is no negative effect on the usage of the chamber.

4. METHODOLOGY

4.1. General Considerations

The performance of an air source heat pump depends on ambient conditions. The experiments are performed in a controlled room to simulate the inner environment conditions of a typical house. The ambient conditions that are maintained and recorded through the experiments are given in Table 4.1.

Table 4.1 Ambient Conditions

Ambient room air temperature	24 ± 1 °C
Relative humidity	$40 \pm 10\%$
Atmospheric Pressure	~ 100 kPa

In this study, experiments are conducted on refrigerator and clothes dryer chambers. The schematic experimental setup is presented in Figure 4.1.

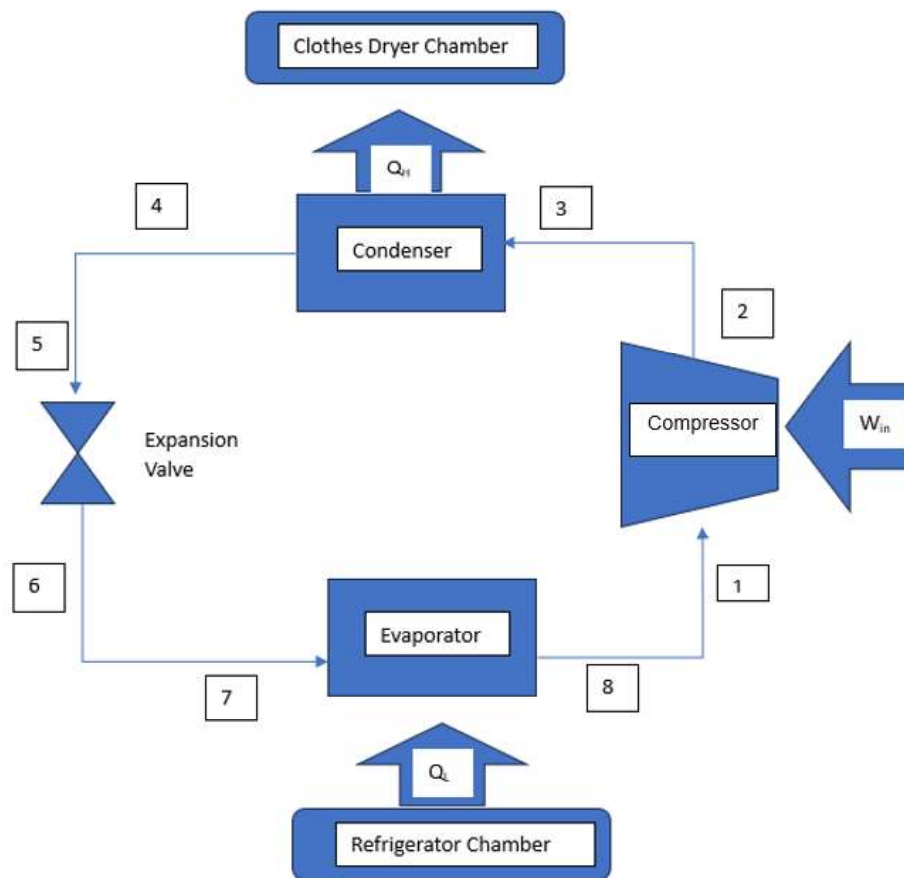

Figure 4.1. Schematic experimental setup

In the refrigerator and clothes dryer machine, the cycle starts in the compressor inlet. The refrigerant is compressed in the compressor. The pressurized refrigerant reaches the condenser and its heat is transferred to the clothes dryer chamber. Through the capillary tube, the pressure is reduced, heat transfer occurs from the refrigerator chamber to low pressure refrigerant in the evaporator. Again, refrigerant returns to the inlet of the compressor.

Two identical temperature and humidity sensors are used. One of them is placed in the refrigerator chamber and the other is placed in the clothes dryer chamber. The properties of the temperature and the humidity sensor and their accuracy are described in Appendix-1. The sensor has memory storage for historical data. Thanks to this feature, the temperature, and humidity values are collected. Moreover, they are able to send humidity and temperature information via Bluetooth technology to the cell phone, so it is easy to see and collect temperature and humidity information. In this way, there is no need to open chambers' doors in order to see and collect temperature and humidity information.

The second type of sensor is used to find fan power. The input power of the fan is determined as 1,5 W thanks to the amper and voltage indicator device. It can show the amper and voltage amount if it is plugged into a USB port before the fan.

Finally, a digital baby scale is used for weight measurements. Baby scales must be very accurate because, for new-born babies' health, it is necessary to measure their weight changes. WWD700 is chosen and procured for the experiment. Its operation range covers the experiment conditions.

Experimental equipments are shown in Figure 4.2



Figure 4.2. Experimental equipment

temperature and humidity sensor, amper and voltage indicator and a digital scale, which are described above paragraphs, are given in Figure 4.2 respectively.

After that, procurement, production, and assembly processes are completed for the heat pump device. The experimental setup is produced according to drawings. The device appears as the following figures.

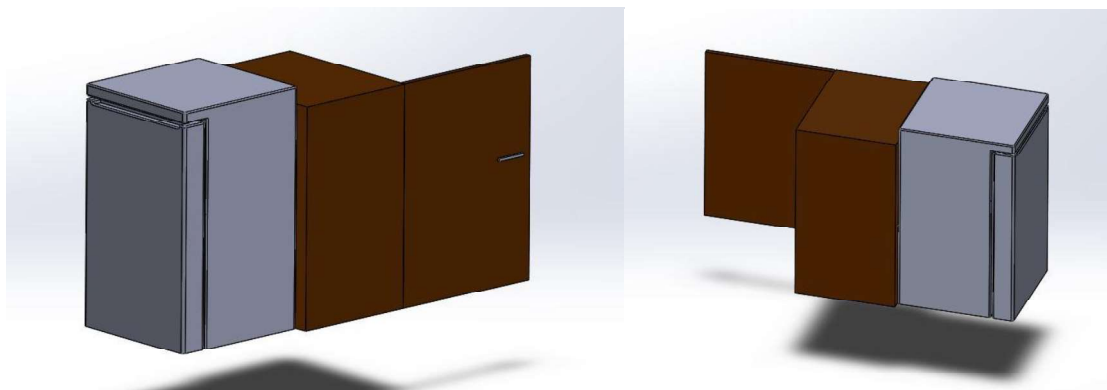

Figure 4.3 Designed system view from different aspects

Figure 4.3 is drawn via Solidworks software. The outer surface of the refrigerator chamber is made from metal and the inner surface is made from plastic material. The

outer and inner surfaces of the clothes dryer chamber are manufactured from wooden material. The gap between the inner and outer surfaces of both chambers is filled with polyurethane.

A fan is mounted clothes dryer chamber. Its function is essential for the circulation of the air inside of clothes dryer. It is estimated that the heat transfer rate between hot air and wet clothes increases. The humidity of clothes decreases rapidly. However, it should be determined that the most efficient design among with fan from above or below.

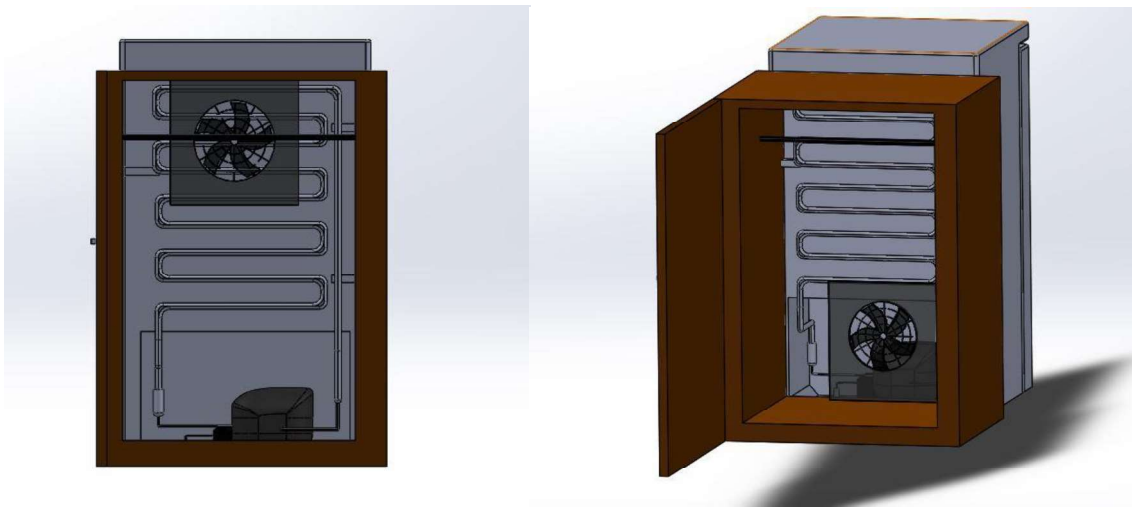

Figure 4.4. System view with fan from above and below positions

Figure 4.4 shows fan from above and below designed heat pump systems. These designs are used for several test steps. Detailed drawings of the designed system are given in Appendix 2.

The general view of the produced experimental setup, sensor and device and load placing are shown in Appendix 3.

The refrigerator chamber involves 20,5 L of water in the normal refrigerator compartment (cooler) and 3 L of water in the freezer compartment at 24 °C. specific heat of water is taken as 0,001 m³/kg. Temperature decreases to 5 °C in the cooler compartment and to -18 °C in the freezer compartment. The total surface area of the refrigerator chamber is 2,1 m² and it has 0,2 m³ volume.

4.2. Experimental Methodology

The heat pump uses the evaporator in order to reject the heat from the refrigerator chamber and the condenser of the heat pump transfers this heat to the clothes dryer chamber. In this thesis, following 6 steps are determined for experiments.

1. The drying duration of a certain amount of clothing should be measured when the system is not working.
2. Step 1 above should be repeated by running only the fan without starting the heat pump system.
3. Step 1 should be repeated by turning off the fan and starting the heat pump system. For the clothes dryer chamber, the performance and efficiency of the heat pump should be calculated. Thus, the effectiveness of the clothes dryer function can be measured in the first three steps.
4. Step 1 should be repeated by starting the heat pump system and turning on the fan
 - a. with from above,
 - b. with from below.

The performance and efficiency of the heat pump should be calculated.

5. Cooling performance of the refrigerator chamber of the same heat pump should be measured with and without the clothes drying function.
6. Finally, energy savings and efficiency should be calculated by using both refrigerator and clothes dryer functions at the same time.

5. RESULTS AND DISCUSSION

5.1. Experimental Results

In this thesis, 6 test steps are executed respectively. Results are given as follows.

1. The drying duration of a certain amount of clothing should be measured when the system is not working.

The step is performed with a very wet hooded sweatshirt (it means without wring) in ambient conditions. After 14 hours and 49 minutes duration it has not dried yet. The weight does not decrease to the initial value after a very long time. It is still 925 g (dry weight is 580 g).

Table 5.1 Wet hooded sweatshirt (without wring) after 14:49 time duration.

Refrigerator	Clothes Dryer	Fan
N/A	N/A	N/A

Date	Hour	Dry Hooded Sweatshirt (g)	Wet Hooded Sweatshirt (g)	Time Difference (h)	Weight Difference (g)
Day 1	10:36	580	1705		
	12:23		1505	1:47	200
	14:03		1415	03:27	290
	15:25		1285	04:49	420
	19:22		1045	08:46	660
	21:52		960	11:16	745
Day 2	01:25		780	14:49	925

After this result, it is decided to use shirts which are wried by wring function of washer machine at 1000 rev./min. The results are described in Table 5.2.

Table 5.2. Drying cycle of shirts in ambient conditions.

		Refrigerator	Clothes Dryer	Fan			
		N/A	N/A	N/A			
Date	Hour	Temperature (°C)	Humidity (RH)	Dry Weight (g)	Wet Weight (g)	Time Difference (h)	Weight Difference (g)
Day 1	12:23	24	51	640	905	05:17	185
	17:40	21	54		720	06:00	215
	18:23	20,2	63		690	06:57	240
	19:20	21,1	59		665	10:56	260
	23:19			645			

It takes 10 hours and 56 minutes to dry without fan and clothes dryer function.

- Step 1 above should be repeated by running only the fan without starting the heat pump system. Keep in mind that, clothes are inside the clothes dryer chamber. The fan circulates the air inside the clothes dryer chamber. The heat pump system is closed.

Table 5.3. Drying cycle of shirts with fan without the clothes dryer.

		Refrigerator	Clothes Dryer	Fan			
		Off	Off	On			
Date	Hour	Temperature (C)	Humidity (RH)	Dry Weight (g)	Wet Weight (g)	Time Difference	Weight Difference (g)
Day 1	10:40	23,7	47	640	900		
	12:41	19,3	61				
	13:52				775	03:12	125
	15:25	23,7	51	645		04:45	255

It takes 4 hours and 45 minutes to dry with fan and without the clothes dryer function. Keep in mind that this duration is 10 hours and 56 minutes for Step 1. At this stage, it can be said that fan is useful in order to shorten the period of drying.

- Step 1 should be repeated by turning off the fan and starting the heat pump system. For the clothes dryer chamber, the performance and efficiency of the heat pump should be calculated. Thus, the effectiveness of the clothes dryer function can be seen.

Table 5.4. Drying cycle of shirts with clothes dryer without fan.

		Refrigerator	Clothes Dryer	Fan			
		On	On	Off			
Date	Hour	Temperature (°C)	Humidity (RH)	Dry Weight (g)	Wet Weight (g)	Time Difference (h)	Weight Difference (g)
Day 1	02:52	29,1	40	640	925		
	08:56	27,4	56		710	6:04	215
	10:13	28,2	51		670	7:21	255

It takes 7 hours and 21 minutes to dry with the clothes dryer function and without fan. Keep in mind that this duration is 10 hours and 56 minutes for Step 1. At this stage, it can be said that the clothes dryer function is useful, it takes less time than the ambient condition for drying. However, it seems a basic fan is more beneficial than only clothes dryer function. Moreover, as it will be seen in Test Step 5, the efficiency of the refrigerator has dropped compared to the case that only clothes dryer function is used without fan. The reason behind this is that hot air cannot circulate in the clothes dryer chamber. Moreover, the heat transfer rate between hot air and wet clothes is low, so the compressor and condenser cannot get rid of hot air. Neither refrigerator efficiency can be kept high, nor clothes dryer chamber can be used effectively. Thus, it is thought that the following step will be able to satisfy the curiosity, and the effectiveness of the clothes chamber can be easily seen after monitoring the result of the clothes dryer chamber with fan.

4. Step 1 should be repeated by starting the heat pump system and turning on the fan
 - a. with above,

At the beginning of Test Step 4, it is investigated that whether the wet hooded sweatshirt (without wring), which is still wet after 14:49 time duration in Test Step 1, can be dried or not.

Table 5.5 Drying cycle of hooded sweatshirts (without wring) with clothes dryer and fan (above).

		Refrigerator	Clothes Dryer	Fan			
		On	On	On			
Date	Hour	Temperature (°C)	Humidity (RH)	Dry Weight (g)	Wet Weight (g)	Time Difference (h)	Weight Difference (g)
Day1	23:26	24,5	34	580 gr	1705		
	23:30	23,9	42				
Day2	02:15	31,1	36		1375	2:49	330
	02:46	29,1	51		890	3:20	815
	07:58	27,2	42				
	11:31	31,5	32	655		12:05	1050

After 12 hours and 5 minutes, the laundry is dried at long last. The system is successful since the wet hooded sweatshirt (without wring), which is still wet after 14:49 time duration in Step 1.

Getting back to the shirts with wring at 1000 rev./min, the result is as shown in the following table.

Table 5.6. Drying cycle of shirts with clothes dryer and fan (above).

		Refrigerator	Clothes Dryer	Fan			
		On	On	On (above)			
Date	Hour	Temperature (°C)	Humidity (RH)	Dry Weight (g)	Wet Weight (g)	Time Difference	Weight Difference (g)
Day							
1	21:20	26,2	45	640	940		
	02:15	31,1	36	640		4:55	300

It takes 4 hours and 55 minutes to dry with fan (above) and clothes dryer function. This duration is 10 hours and 56 minutes for Step 1. It takes 7 hours and 21 minutes to dry with clothes dryer function and without fan in

Step 3. Although, the fan increases drying efficiency in Step 4a, it takes 4 hours and 45 minutes to dry with fan and without clothes dryer function (Step 2), so clothes dryer chamber is less useful for clothes dryer than only the fan condition at first view. On the other hand, if weight differences are compared, it can easily be seen that the amount of evaporation in Step 4a is bigger than Step 2's. Moreover, if weight differences are divided by duration, the ratio for Step 4a is higher again. Also, the clothes dryer chamber temperature rises to 31,1 °C and humidity decreases to 36 in Step 4a. Compared to the temperature and humidity levels of Step 2 and Step 3 temperature and humidity level of Step 4a is higher. It can be stated that a heat pump is useful. However, it does not create a big difference. The reason is probably that fresh air cannot be circulated in the clothes drying chamber, since the door is closed. The problem can be solved with the help of fan position change which will be studied below.

b. with below:

Table 5.7 Drying cycle of shirts with clothes dryer and fan (below)

		Refrigerator	Clothes Dryer	Fan			
		On	On	On	On		
					(below)		
Date	Hour	Temperature (°C)	Humidity (RH)	Dry Weight (g)	Wet Weight (g)	Time Difference	Weight Difference (g)
Day 1	22:16	27	57		970		
Day 2	01:23	29,2	56		675	3:07	295
	01:54	31,2	50	650		3:38	320

The drying duration for this case is 3 hours and 38 minutes. In less than 4 hours, 320 g of water is evaporated.

The efficiency of test steps is determined by a method that is a ratio of weight loss and drying duration. This slope shows the rate of the amount of evaporated water.

Table 5.8. Drying duration of shirts of all test steps

	Fan	Heat Pump	Time (hour)	Weight Difference (g)	Weight Difference/Time (g/h)
Step 1			10:56	260	23,78
Step 2	X		04:45	255	53,68
Step 3		X	07:21	255	34,69
Step 4a	X (above)	X	04:55	300	61,02
Step 4b	X (below)	X	03:38	320	88,07

The above table states the amount of evaporated water and spent waiting time. From this table, the following graph is gained. In addition, for convenience, the fan and heat pump working status is marked as “x” meaning that it is open.

The drying rate (DR) is the ratio of the amount of moisture removed to the drying time and it is gained by the following formulation (Mahlia et al., 2010):

$$DR = \frac{(weight\ of\ moisture\ removed)}{(drying\ time)}$$

The drying rate for each drying case is calculated and the following graph is gained.

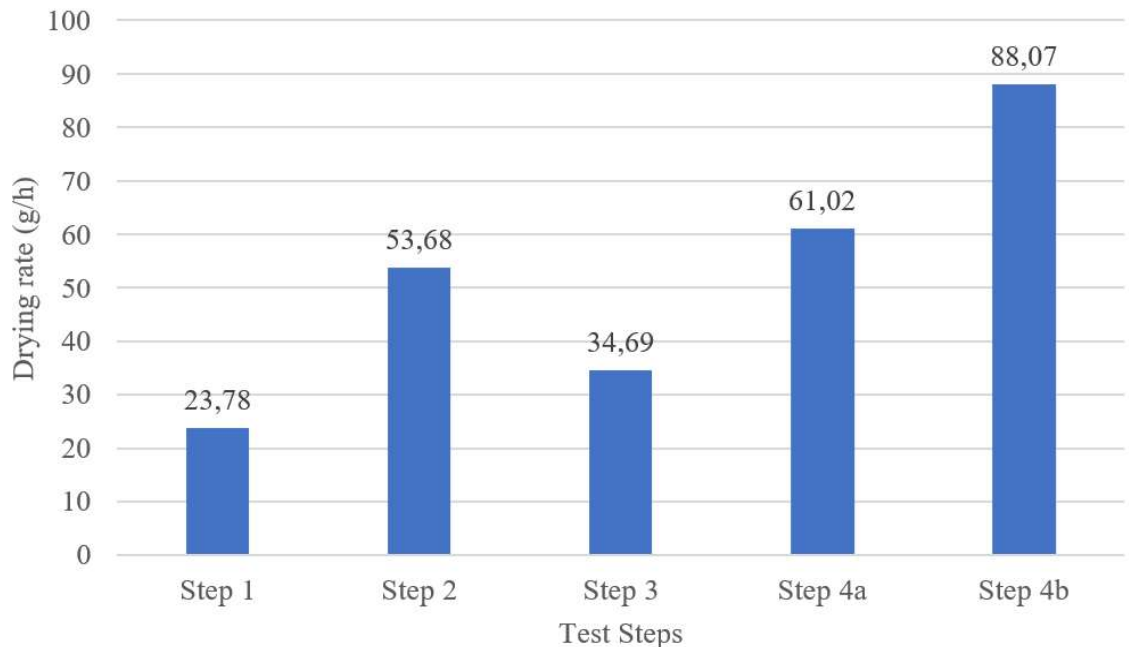

Figure 5.1. Drying Rate of All Test Steps

The above figure monitors the drying rate of different methods. The rate of Step 4b is extremely higher than others as expected. It has the perfect

configuration and positioning of the fan. The second efficient step for drying is Step 4a. It has the perfect configuration, but the above fan position is not the best. If there is no fan, drying chamber efficiency sharply decreases as seen in Step 3. The reason is probably that fresh air cannot be circulated in the clothes dryer chamber since the door of the clothes dryer chamber is closed. On the other hand, all steps that have the clothes dryer chamber are more useful than ambient temperature conditions.

The maximum temperature that is observed in the clothes dryer chamber is 34,6 °C (wet clothes are inside the chamber). From this point of view, 34,6 °C is normal for the inside temperature of the clothes dryer chamber since it contains wet clothes and air volume with moisture. It should be noted that the ambient temperature is around 24 °C. The heat pump has the capacity to raise the inside temperature of the clothes dryer chamber by approximately 10 °C. Moreover, the energy balance of the clothes dryers is analysed in the Analytical Validation section. For these calculations, the case that clothes dryer chamber when it contains only air is used and the inside temperature of the clothes dryer chamber raises to 55 °C.

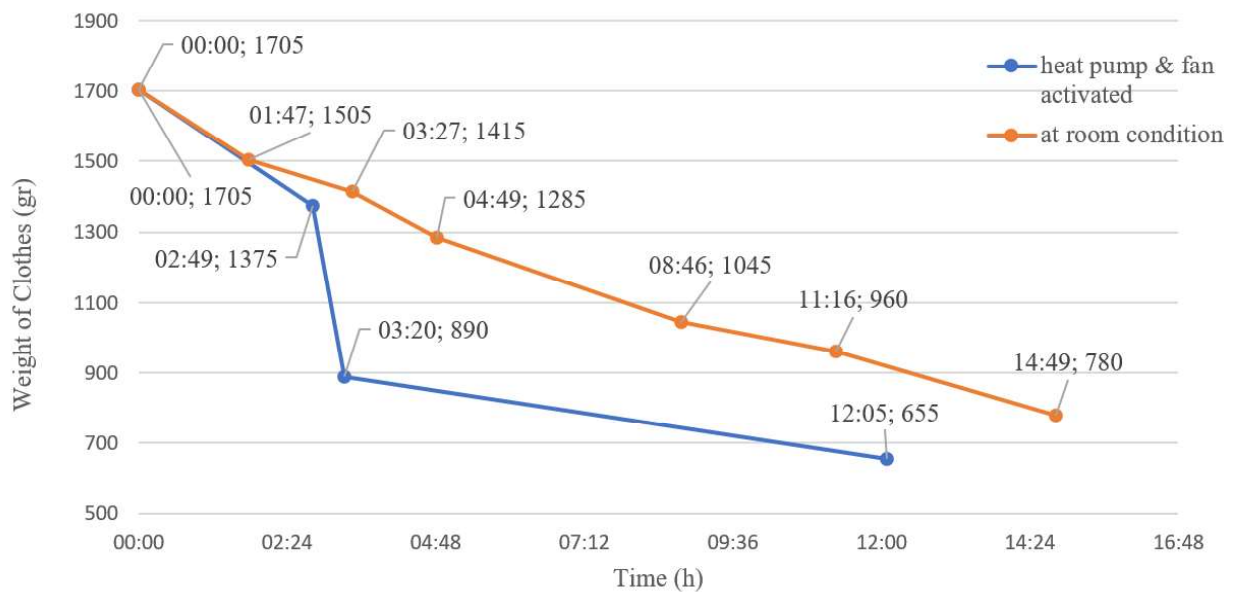

Figure 5.2. Weight change of wet hooded sweatshirt (without wring) vs. time
 Figure 5.2 illustrates the weight loss of the wet hooded sweatshirt caused by drying. Related data are shown in Table 4 of Test Step 1 and Table 7 of Step 4a. This figure also proves the utility of the clothes dryer chamber. The difference is created by the waste energy of refrigerating activity.

5. Cooling performance of the refrigerator chamber of the same heat pump should be measured with and without the clothes drying function.

For this step, there are three main observations are made. First of all, the heat pump is operated without clothes dryer chamber. Inside temperature and humidity levels of the refrigerator chamber are measured. Then heat pump is operated with the clothes dryer chamber; temperature and humidity data are collected again. Finally, the heat pump is operated with the clothes dryer chamber and fan with below position.

The temperature and humidity values of the first observation are tabulated in Appendix 4 Table 1. The experiment finishes after 29 hours and 54 minutes when the inside temperature, which is 23,7 °C at the beginning, decreases to 4,8 °C. The average temperatures of the first and last 1 hours are 23,6 °C and 5,1 °C respectively.

For the second observation, the heat pump is operated with the clothes dryer chamber; temperature and humidity data are collected again and are tabulated in Appendix 4 Table 2. The experiment finishes after 35 hours and 46 minutes when the inside temperature, which is 24,5 °C at the beginning, decreases to 4,6 °C. The average temperatures of the first and last 1 hours are 24,1 °C and 5,1 °C respectively.

For the third observation, the heat pump is operated with the clothes dryer chamber and fan with below position. The third observation results are shown in Appendix 4 Table 3. The experiment finishes after 3 hours and 37 minutes when the inside temperature, which is 22,5 °C at the beginning, decreases to 14,5 °C. The average temperatures of the first and last 1 hours are 24,7 °C and 17,2 °C respectively. The duration of the last observation is shorter than previous ones because, shirts in the clothes dryer chamber are dried as shown in Step 4c in a short period of time. In addition, temperature differences per 1 hour for the first and the second hours proved that refrigerating efficiency is higher than the efficiency of previous observations. This approach helps to avoid any waste of time. The inside temperature and relative humidity of the refrigerator chamber with clothes dryer chamber and fan (below) drop more rapidly than others.

The data gained from these three observations are monitored below graphs. The blue line represents the inside temperature of the refrigerator chamber

with the clothes dryer chamber only, the orange one is for without the clothes dryer chamber and the grey one is for with the clothes dryer chamber and fan case.

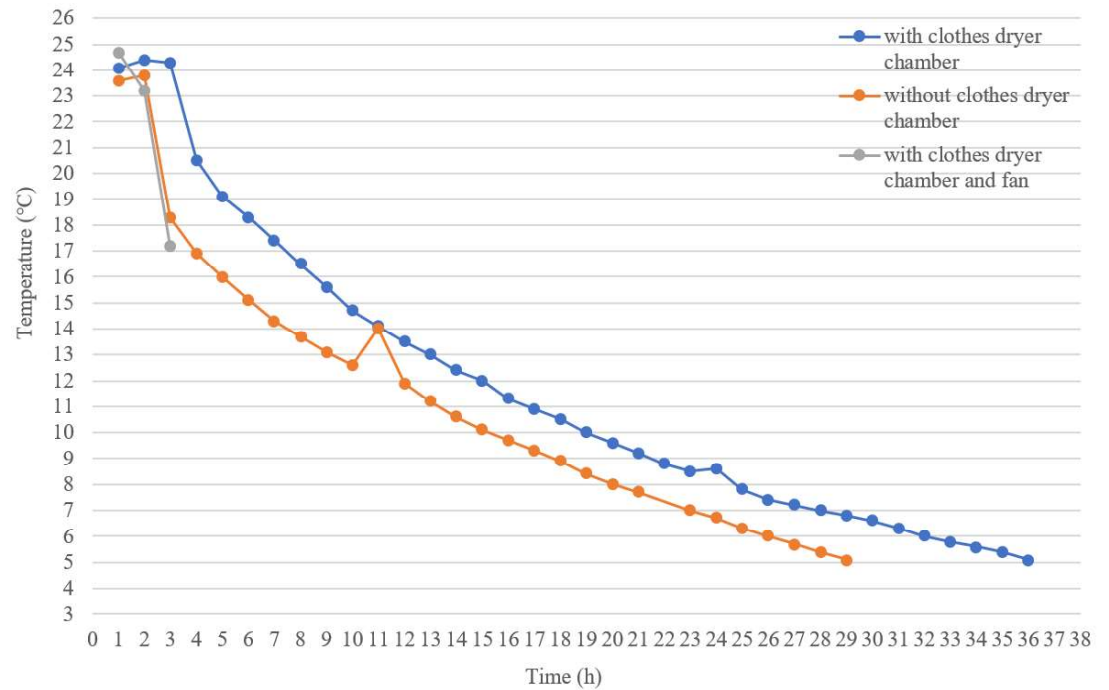

Figure 5.3. Variation of the inside temperature of the refrigerator with respect to time

Thanks to this figure, it can be easily seen that the most efficient case for the refrigerator chamber is the third observation (with the clothes dryer chamber and fan case). Without a fan, the clothes dryer chamber decreases its refrigerating capacity. Considering clothes dryer efficiency results, using a heat pump system for refrigerating and drying purposes with a fan is beneficial. It is a useful model.

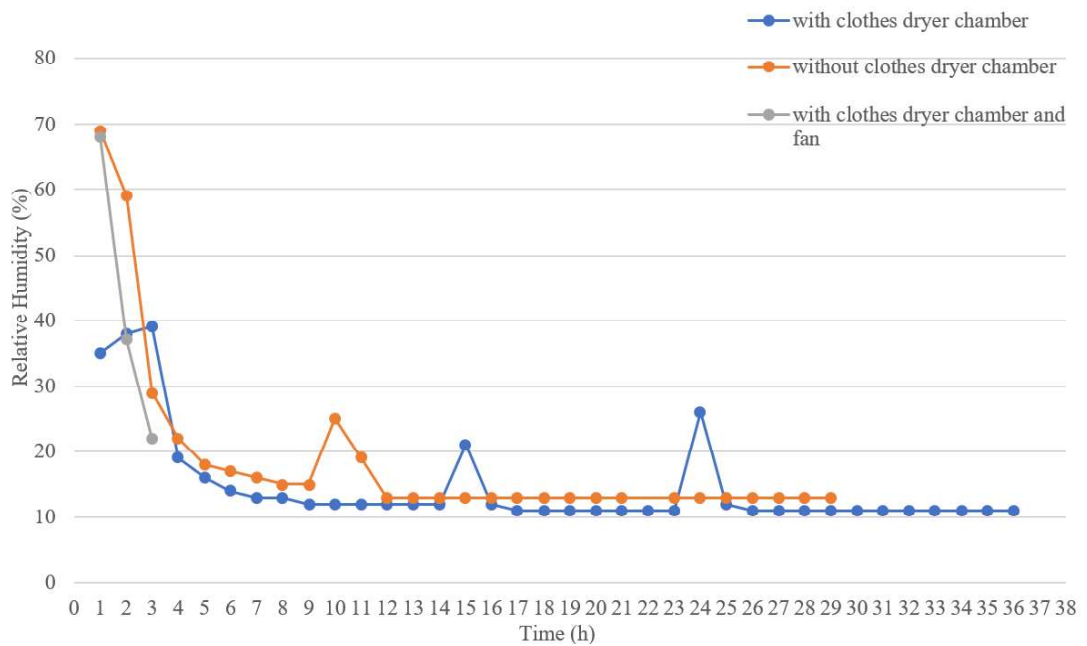

Figure 5.4. Variation of inside RH of the refrigerator with respect to time

Figure 5.4 illustrates the relationship between temperature drop and relative humidity (RH). There is a correlation between the inside temperature of the refrigerator chamber and the RH level.

- Finally, energy savings and efficiency should be calculated by using both refrigerator and clothes dryer functions at the same time.

Achieved results in Test Step 4b are very fruitful. Fan location does not only sharply increase the heating capacity of the clothes dryer chamber but also increases the inside temperature drop rate of the refrigerator chamber.

Table 5.9 shows EF values of the heat pump used experimental steps.

Table 5.9. Necessary data to calculate EF and EF values

	Fan	Heat Pump	Time (hour)	Dry Weight (g)	Power (W)	EF (kg/kWh)
Step 3		x	07:21	640	52,1	1,67
Step 4a	x (above)	x	04:55	640	52,1	2,49
Step 4b	x(below)	x	03:38	640	52,1	3,38

From the above table, it can be said that only the Step 3 case is not efficient as a clothes dryer since the minimum acceptable value for EF is 1,69. On the other hand, as the design uses waste heat, it should be noted that all cases are

useful for heat recovery. The reason is that there is no additional effort to gain this heat energy because the insulation inside the clothes dryer chamber keeps the heat energy that used to go atmosphere before.

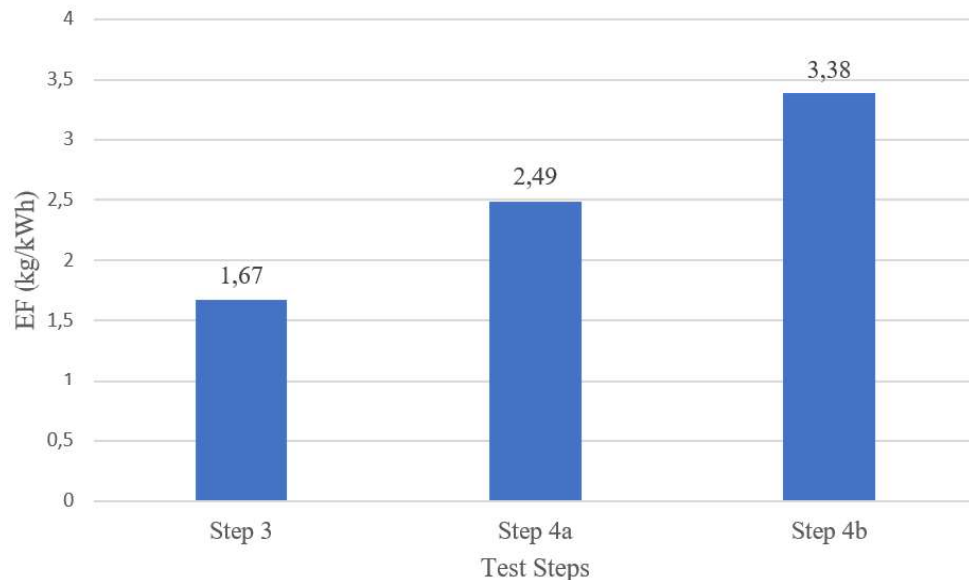

Figure 5.5. Energy Factors of heat pump used test steps

The above figure shows EF of all test steps in one chart. As can be seen, step 4b has the greatest EF. In addition, the moisture removed per unit of energy consumption (SMER) is also given below.

Table 5.10. Necessary data to calculate SMER and SMER values

	Fan	Heat Pump	Time (hour)	Weight Difference (g)	Power (W)	SMER (kg/kWh)
Step 3		x	07:21	255	52,1	0,66
Step 4a	x (above)	x	04:55	300	52,1	1,17
Step 4b	x(below)	x	03:38	320	52,1	1,69

SMER value is also higher than Mahlia's experiments. The reason may be the size of the heat pump system. The insulation and ventilation conditions may cause the difference.

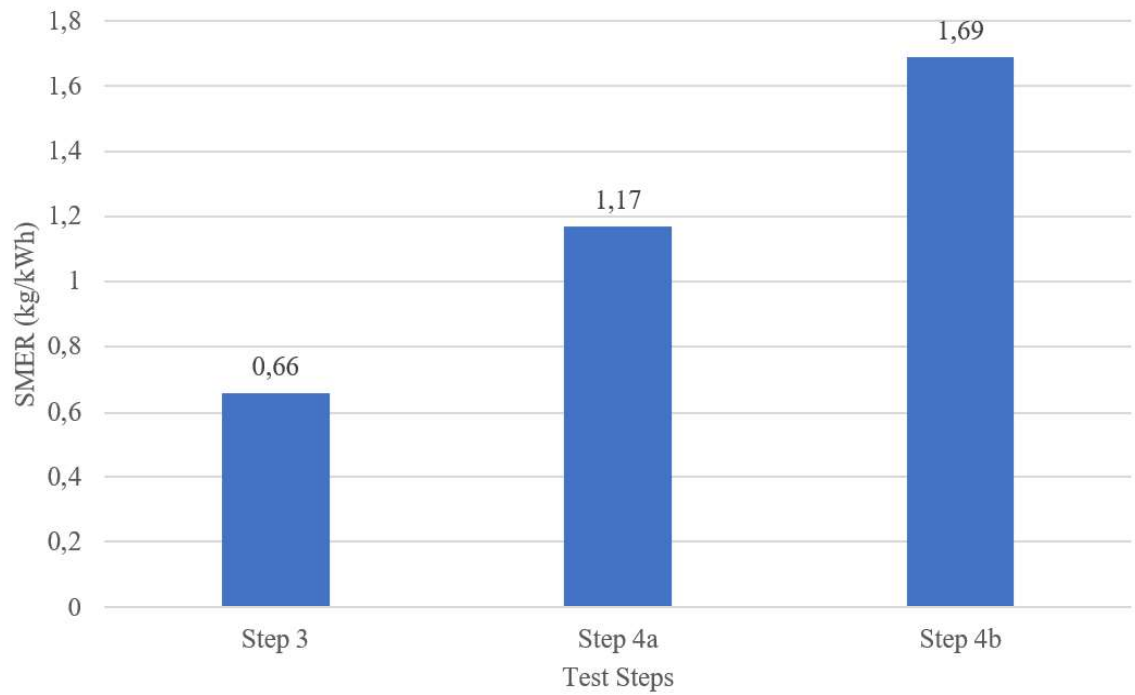

Figure 5.6. SMER of heat pump used test steps

Figure 5.6 monitors SMER level of all test steps. A correlation may be seen between SMER and EF data. Sorting by EF magnitude is Step 4b, 4a, and 3 respectively. Sorting by SMER magnitude is also Step 4b, 4a, and 3 respectively.

5.2. Analytical Validation

To confirm the experimental findings, the energy usage of the heat pump system is roughly determined through thermodynamic analysis of the heat pump cycle, and then compared to the recorded measurements.

Initial Heat Pump Cycle

For the actual cycle, the p-h diagram dynamically shifts upwards while the compressor is running. Therefore, the first cycle is accepted as instantaneously ideal when it is analysed.

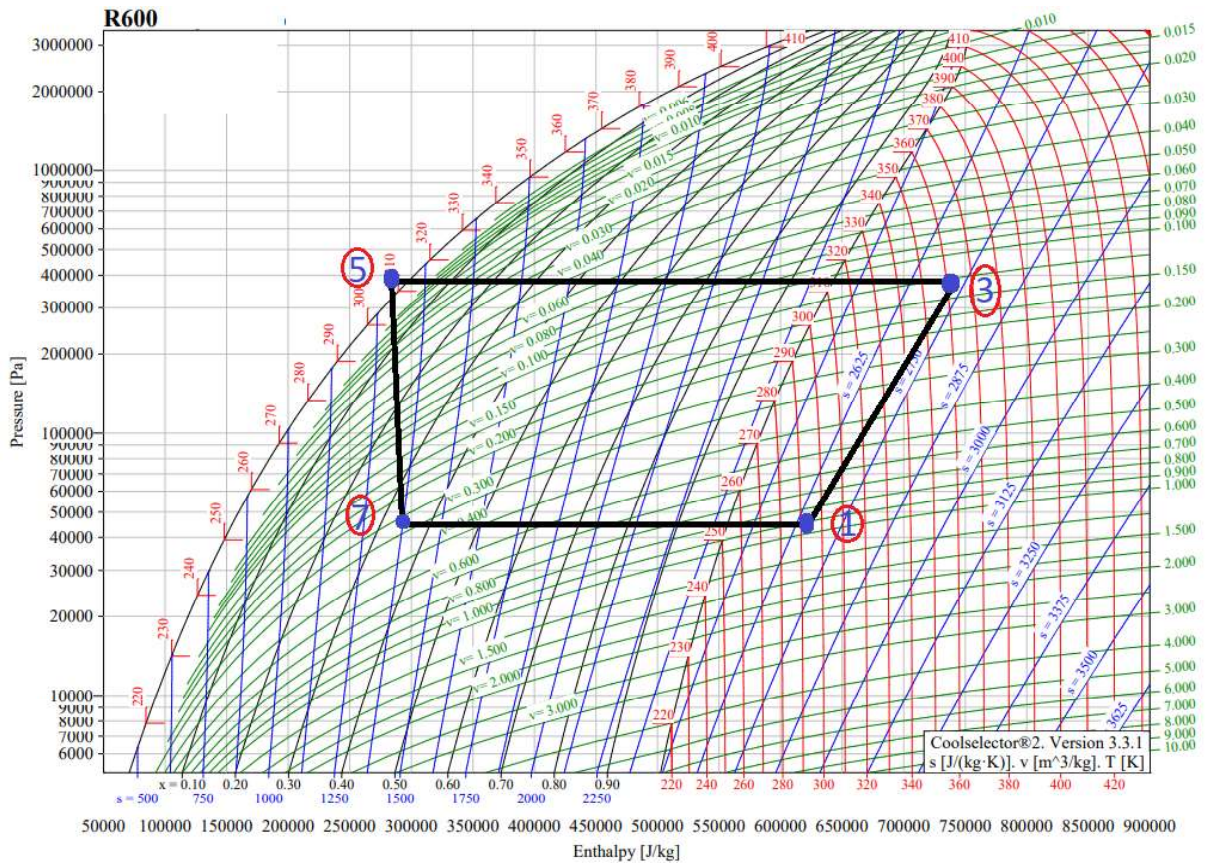

Figure 5.7. P-h diagram of the first cycle of heat pump system.

The compressor power \dot{W}_c , heat transfer rate \dot{Q}_{out} and \dot{Q}_{in} are found using following equations available in literature respectively (Moran et al., 2010).

$$\dot{W}_c = \dot{m}(h_2 - h_1) \quad (5.1)$$

$$\dot{Q}_{out} = \dot{m}(h_3 - h_4) \quad (5.2)$$

$$\dot{Q}_{in} = \dot{m}(h_8 - h_7) \quad (5.3)$$

The calculations are executed. The results were found as 40,7 W, 171,5 W, and 128,8 W respectively. In addition, the electric consumption of the system is 52,1 W. Keep in

mind that the cycle is assumed as ideal, so calculated heat transfer rates \dot{Q}_{out} and \dot{Q}_{in} are impossible to achieved continuously in a real case. Moreover, they are decreasing cycle by cycle because of the difference between an actual vapor compression cycle and an ideal cycle as stated in Chapter 3.

Calculating the Cooling Load of the Refrigerator Chamber

The cooling load on refrigerating equipment results from the summation of the heat which usually evolves from different sources (Dossat, 2010). A short method of load calculation that contains load factors that have been determined by experience is given by Dossat (2010). With this method, the entire cooling load is divided into two parts which are the wall gain load and the usage load.

$$\dot{Q}_{wall} = (A)(U)(TD) \quad (5.4)$$

where \dot{Q}_{wall} : the rate of heat transferred (W)

A: the outside surface area of the wall (m²)

U: the overall coefficient of heat transmission (W/m²K)

TD: The temperature differential across the wall (K)

The usage load is computed by the following equation:

$$Usage\ load\ (W) = interior\ volume\ (m^3) \times usage\ factor \times TD \quad (5.5)$$

Note that, Dossat (2010) lists the usage factor which varies with the interior volume of the cooler and are given in W/m³K.

$$Cooling\ load\ (W) = Usage\ load + \dot{Q}_{wall} \quad (5.6)$$

By applying Eqn. 5.6, cooling load is found as 49,7 W.

Calculating the Heat Requirement of the Clothes Dryer Chamber

A 0,555 m x 0,740 m x 0,390 m wooden chamber insulated with polyurethane is used for clothes dryer purposes. In order to find the heating capacity of the heat pump, different approaches are used.

The first approach is using energy and mass balance equations for the air and vapour mixture inside the clothes dryer chamber. Calculations are executed for Step 3, Step 4a and Step 4b cases, because the device is activated only for these cases. In addition to them, clothes dryer chamber that contains only air at 28,5 °C temperature and relative humidity of 41% initial situation. In other words, there are no wet clothes inside the clothes dryer for this additional case. After 1 hour of operation of the heat pump, the final situation temperature and humidity data are read as 55 °C and 27%.

Table 5.11. Heat pump used test steps.

	Fan	Heat Pump	Time (hour)	Vaporized Water Amount (g)
Step 3		x	07:21	255
Step 4a	x(above)	x	04:55	300
Step 4b	x(below)	x	03:38	320
Additional case	-	x	01:00	-

Table 5.11 summarized heat pump operated cases that are used for the calculation. Initial and final temperature and humidity values are given in Appendix 4 Table 4. The dry air pressure, specific humidity, enthalpy, and the masses of dry air and water vapour in the chamber are determined to analyse the energy balance. It is assumed that mass of air is constant during the process.

The partial pressure of dry air is found from following equation:

$$P_a = P * P_v \quad (5.7)$$

where

$$P_v = \phi P_g = \phi P_{sat@^{\circ}C} \quad (5.8)$$

where P_a and P_v are partial pressures of dry air and vapour respectively. P is the ambient pressure and ω is the specific humidity of air. The enthalpy of air per unit mass of dry air is h.

The dry air and the water vapour in the chamber are assumed as ideal gases. The constant pressure c_p , P_{sat} , u_g are given by Çengel (2006) in Table A-2a and Table A-4.

The volume of each gas is equal to the volume of the chamber.

$$V_a = V_v = V_{chamber} \quad (5.11)$$

The masses of the dry air (m_a) and the water vapour (m_v) are determined from the ideal gas relation applied to each gas separately:

$$m_a = \frac{P_a V_a}{R_a T} \quad (5.12)$$

$$m_v = \frac{P_v V_v}{R_v T} \quad (5.13)$$

where R is gas constants for the air and vapour (Çengel (2006) at Table A-2a).

Disregarding kinetic and potential energy changes energy balance relation can be expressed as following:

$$Q_{in} = U_2 - U_1 \quad (5.14)$$

$$Q_{in} = (m_a u_2 + m_{v2} u_{v2}) - (m_a u_1 + m_{v1} u_{v1}) \quad (5.14)$$

where u_v is internal energy of saturated vapour ($u_{g@^{\circ}C}$) (Çengel (2006) at Table A-4). Eqn. 5.5 is recalled in order to find insulation loss Q_{wall} . Multiplying by process duration, the energy loss because of the insulation Q_{wall} is found in Wh. By applying Eqn. 5.15, heat requirement can be determined. *Heat Requirement (Wh)* = $Q_{in} + Q_{wall}$ (5.15)

Heat requirements that are gained by the first approach, are as following.

Table 5.12. Heat requirements calculated by the first approach

	Q _{total} (Wh)
Step 3	56,78
Step 4a	64,17
Step 4b	48,23
Additional case	59,57

Q_{out} is found as 171,5 W above. Q_{out} for step 3, 4a, 4b and additional case are 1260,53, 843,21 and 623,12, 171,5 Wh respectively. Considering Table 5.12 the first approach is not successful to guess condenser heating.

Table 5.13. Comparison of heat requirement of the first approach and condenser heating

	Q _{total} (Wh)	Q _{out} (Wh)	Q _{total} /Q _{out}
Step 3	56,78	1260,53	5%
Step 4a	64,17	843,21	8%
Step 4b	48,23	623,12	8%
Additional case	59,57	171,5	35%

At first appearance, the absorbability of the clothes dryer chamber of the supplied heat energy is low. The case that contains only air (additional case) seems reasonable since 35% of the heating energy can be used. There are several reasons behind the performance drop of Step 3, Step 4a and Step 4b (cases contain wet clothes). The first reason is the door is opened periodically in order to measure the weight of the clothes, so the isolation of inside air-vapour mixture is not perfect as additional case. The second

reason is that inner body of the clothes dryer is manufactured by wooden material. This material can be absorbed moisture inside and can decrease the humidity. The mass balance equation results that is given below support these reasons. The third reason is neither air nor vapour are ideal gases. This reason is valid for all cases including additional case.

Since the air mass is assumed as constant, the mass balance of vapour can be expressed as following:

$$m_{v2} - m_{v1} = m_{vaporized} \quad (5.15)$$

m_{v1} and m_{v2} are found by Eqn. 5.13, $m_{vaporized}$ is found by experimentally. The results are as follows.

Table 5.14. Mass of vapour and water of different test steps

	$m_{v2}(g)$	$m_{v1}(g)$	$m_{vaporized}(g)$
Step 3	2,27	1,86	255
Step 4a	1,87	1,78	300
Step 4b	2,61	2,37	320

As can be seen, almost all the water inside the wet clothes is vaporized and absorbed by inner surface of the clothes dryer and insulation material between surfaces or escaped to the room. The final vapour masses of all test steps are greater than initial value as expected but the difference is so small with respect to vaporized water amount. Thus, the second approach can be more accurate to determine usable heat energy that is supplied by the condenser.

The second approach is determining heat energy that is required in order to remove water from wet clothes. The equation can be expressed as following:

$$Q_{required} = m_{water}c_{water}\Delta T + m_{water}L \quad (5.16)$$

where L is latent heat.

$Q_{required}$ of all necessary test steps are found by Eqn. 5.16 and compared with Q_{out} in Table 5.15.

Table 5.15. Comparison of heat requirement of the second approach and condenser heating

	Q_{required} (Wh)	Q_{out} (Wh)	$Q_{\text{required}}/Q_{\text{out}}$
Step 3	182,42	1260,53	%14
Step 4a	214,48	843,21	%25
Step 4b	229,52	623,12	%37

This approach is more reasonable since usable heat is closer to the condenser supplied energy than the first approach results. The energy that is required to remove water from clothes for the additional case cannot be calculated because it contains only air and vapour. However, the usable heat per condenser supplied energy ratio of the additional case is in the same range of the second approach result of test steps. As expected from previous sections Step 4b is the most effective test step and Step 3 has the worst performance. The second approach results are compatible with test results.

As mentioned above, the electric consumption of the system is 52,1 W and the cooling load is 49,7 W. Considering uncertainty, leakage, and the other losses the experimental results are reliable. Heat pump capacity is enough to achieve expected temperatures for both cooling and heating purposes. In addition, the usable heat levels are compatible with other heat pump used studies (Orhan, 2007, Kütük, 2019).

5.3. Cost Analyses

Heat pump systems are known as higher cost systems than electric resistance systems in the acquisition, integration, and component maintenance aspects. However, since heat pump systems are energy efficient systems compared to electric resistance systems, the cost of used energy tries to pay off acquisition, integration, and component maintenance cost. These comparison studies are given in the literature survey section. Moreover, electric resistance systems consume extremely higher energy than heat pumps. For example, Tokat's (2012) study shows that 1,25 kWh of energy is consumed for 135 g of moisture removal from clothes. On the other hand, cost analyses of this section have a different focus. The aim of cost analyses is to determine the amortization of clothes dryer chamber cost with a decrease in energy consumption cost of the clothes drying process. Since the system is used waste energy from refrigerating activity, all heating energy of the clothes dryer has no cost to the end user. The clothes dryer chamber cost consists of the following price breakdown structure table. Structural, insulation, and

joint material cost are taken into account. Labour cost is not added since clothes dryers can be mass produced after the research and development phase. Thus, production, quality, and certification processes may have very low costs to producers.

Table 5.16. Price Breakdown Structure of Clothes Dryer Chamber

Product Name	Amount	Unit Price	Total Price
Polyurethane foam for insulation purposes	6 tube x 600 g	58 TL (2,15 \$)	348 TL (12,9 \$)
Wooden cabinet	1	2000 TL (74 \$)	2000 TL (74 \$)
Wooden plate	4 plates for 4 surfaces	50 TL (1,9 \$)	200 TL (7,4\$)
Fan	1	174 (6,4 \$)	174 TL (6,4\$)
Total			2722 TL (100,8 \$)

*27 USD/TL US Dollar (\$) to Turkish Lira (TL) exchange rate is used for the conservation.

Keep in mind that the refrigerator acquisition cost is 4342 TL (164,3 \$) and the total cost of the system is 7064 TL (261,6 \$). If the refrigerator capacity is increased, then clothes dryer chamber cost will be increased. Their prices are in correlation. The electric energy price in Ankara for houses is 1,34 TL/kWh and with taxes and payables 1,5 TL/kWh (0,056 \$). Since components are expensive due to limited production amounts, the initial cost is higher than normal, mass production may be decreased the manufacturing costs. Inflation and consumer price index changes are neglected in calculations. If the clothes dryer chamber is used 16 hours per day, the clothes dryer chamber's initial cost is amortized in 4 years and 11 months, and 5 days. Its operational concept may be very similar to the air dresser design of Samsung (Samsung, 2023). If a compressor that has greater capacity is used in the heat pump system, the clothes dryer chamber may amortize its initial cost more rapidly, since it recovers a bigger amount of wasted energy and manufacturing costs changes are minimal with respect to recovered energy price change.

6. COMMENTS, CONCLUSIONS, AND FUTURE RECOMMENDATIONS

6.1. General

In this study, a dual purpose heat pump that transforms waste heat into useful heat is developed. This heat pump system is able to dry clothes and cool foods. The waste heat drawn from the environment in order to obtain a cooling chamber is used for clothes drying. The designed system is drawn with the use of Solidworks 3D CAD software. The working principles of air source heat pumps, thermodynamic analysis, and prototype component selection are explained. The experimental system is introduced, the applied test method is explained, and the test results are given.

The thesis contains 6 test steps as follows.

1. The drying duration of a certain amount of clothing is measured when the system is not working. It takes 10 hours and 56 minutes to dry without fan and clothes dryer function.
2. Step 1 above is repeated by running only the fan without starting the heat pump system. It takes 4 hours and 45 minutes to dry with fan and without the clothes dryer function.
3. Step 1 is repeated by turning off the fan and starting the heat pump system. It can be said that the clothes dryer function is useful, it takes less time than the ambient condition for drying. The efficiency of the refrigerator has dropped compared to the case that clothes dryer function is not used.
4. Step 1 is repeated by starting the heat pump system and turning on the fan with above. It can be stated that a heat pump is useful for drying purposes. However, it does not create a big difference. The reason is probably that inside air cannot be circulated in the clothes drying chamber, since the door is closed. The problem is solved with the help of fan position change which with below. The efficiency is extremely higher than others.
5. Cooling performance of the refrigerator chamber of the same heat pump is measured with and without the clothes drying function. It is seen that

the most efficient case for the refrigerator chamber is the case with the clothes dryer chamber and fan case.

6. Finally, energy savings and efficiency are calculated by using both refrigerator and clothes dryer functions at the same time.

Analytical validations of these results are checked. The results state the applicability of the studied design. It is seen that our design has a capacity to save 63,17 Wh waste energy from a one-hour operation of a small type of household refrigerator. Also, this recovered energy can be increased by using improved and efficient materials for insulation, because the compressor has a greater heating capacity than recovered. The design is open to developments in this aspect.

6.2. Recommendations for Future Work

In this study, a clothes dryer using waste heat from a household refrigerator is designed and manufactured. The refrigerator is a very small type of heat pump system. Therefore, the designed system can be scaled with the use of dimensionless quantities related to fluid and heat flow such as Reynolds and Prandtl Numbers. In this way, the system enlarges for the service sector such as hotels, restaurants, and hospitals, where energy consumption and equipment costs are extremely high. For example, one room can be used as a refrigerator and the room next door can be used as a clothes dryer room or sauna-spa centre and source of hot water in hotels. Moreover, the heat obtained in the system can be used not only for clothes drying, but also for drying organic materials such as timber, fruit, and vegetable. Also, it can be used as a dehumidification machine.

The system uses an air source heat pump. The applicability of water and soil source heat pump systems for drying purposes can be investigated.

A drum can be added to the clothes dryer chamber of this design. In addition, there is no weather-strip application for the clothes dryer chamber. It can increase the insulation, so more heat energy can be preserved. Filling materials such as silicone can be applied to the attachment points between the refrigerator and clothes dryer chamber. Waste energy recovery can be increased if leakages are decreased in this way. Moreover, moisture absorbers can be used inside the clothes dryer chamber. Thus, humidity can be decreased inside the clothes dryer chamber and the drying velocity of clothes increases since the vapour that is contained in the air is decreased by the moisture absorber.

Wooden material is used in the outer body of the clothes dryer chamber because of its high thermal insulation. However, the life time of wood in humid condition is not so long. Therefore, more moisture-resistant and corrosion-resistant structural materials can be used for domestic and industrial applications that will be operated in continuous humidity.

7. REFERENCES

1. Ankara University. (2023, April). *Expansion Valve*. Ankara Üniversitesi Açık Ders Malzemeleri. Ankara University.
2. Aslan, V. (2007). *Performance Analysis of a Refrigerator* (thesis). Retrieved from https://tez.yok.gov.tr/UlusalTezMerkezi/tezDetay.jsp?id=Ogh3maHDL0k4FHbA9XEEyA&no=_Z_-VdekE0gq2FeiRrPL5w.
3. Bauer, C., Treyer, K., Heck, T., & Hirschberg, S. (2015). Greenhouse gas emissions from energy systems, comparison, and overview☆. *Reference Module in Earth Systems and Environmental Sciences*. <https://doi.org/10.1016/b978-0-12-409548-9.09276-9>
4. Carriço, C., Fraga, T., Carvalho, V., & Pasa, V. (2017). Polyurethane foams for thermal insulation uses produced from castor oil and crude glycerol Biopolyols. *Molecules*, 22(7), 1091. <https://doi.org/10.3390/molecules22071091>
5. Çolak, N., & Hepbasli, A. (2009). A review of heat pump drying: Part 1 – systems, models and studies. *Energy Conversion and Management*, 50(9), 2180–2186. <https://doi.org/10.1016/j.enconman.2009.04.031>
6. *DF60R8600CG Air Dresser: Samsung Türkiye*. Samsung tr. (2020, May 21). Retrieved January 12, 2023, from <https://www.samsung.com/tr/washing-machines/dryer-df60r/DF60R8600CGLE/>
7. Doğan, H., “Isı borulu güneş kolektörü ile kurutma”, P. Ü. Müh. Bil. Dergisi, 5 (1): 921-925 (1999).
8. Dossat, R. J. (2010). *Principles of Refrigeration*. Pearson.
9. Environmental Protection Agency. (n.d.). *Refrigerant Safety*. EPA. Retrieved April 6, 2023, from <https://www.epa.gov/snap/refrigerant-safety>
10. Geeraert B. Air drying by heat pumps with special reference to timber drying. In: Camatini E, Kester T, editors. Heat pumps and their contribution to energy conservation. Leydon: Noordhoff; 1976. p. 219–46.
11. Fuller, S.K. and S.R. Petersen (1995). Life Cycle Costing Manual for the Federal Energy Management Program (NIST Handbook 135). Washington D.C.: National Institute of Standards and Technology (NIST).
12. Gluesenkamp, K. R., Boudreaux, P., Patel, V. K., Goodman, D., & Shen, B. (2019). An efficient correlation for heat and mass transfer effectiveness in tumble-type clothes dryer drums. *Energy*, 172, 1225–1242. <https://doi.org/10.1016/j.energy.2019.01.146>

13. Granryd, E. Energy savings in vapor compression refrigerating systems Proc Int Symposium on refrigeration, Energy and Environment at Trondheim, Norway (June 1992) pp 43-60
14. H. H. (2023, March 17). *LBP, Mbp, and HBP - meaning and application overview*. Kaeltetechnikshop. Retrieved April 16, 2023, from <https://frigopartners.com/blog/lbp-mbp-and-hbp-meaning-and-application-overview>
15. Haldane, T., 1938, The heat pump-an economical method of producing low-grade heat, Journal of the Institution for Electrical Engineers, 68:666-675
16. Hodgett DL. Efficient drying using heat pump. Chem Eng 1976:510–612.
17. Joybari, M. M., Hatamipour, M. S., Rahimi, A., & Modarres, F. G. (2013). Exergy analysis and optimization of R600A as a replacement of r134a in a domestic refrigerator system. *International Journal of Refrigeration*, 36(4), 1233–1242. <https://doi.org/10.1016/j.ijrefrig.2013.02.012>
18. Karmazin, J. U.S. Patent No. 2.199,631 (1940)
19. Kütük, E. (2019). *Experimentation And Optimization Of A Heat Pump Integrated Dishwasher* (thesis).
20. Lawrance, J.S., 2003, Refrigeration Fundamentals Throught History, University of Alabama, Literature Seminer, United States of America, 9p
21. Mahlia, T. M., Hor, C. G., & Masjuki, H. H. (2010). https://www.researchgate.net/publication/232923552_A_Study_on_Residential_Clothes_Drying_Using_Waste_Heat_Rejected_from_a_Split-Type_Room_Air_Conditioner_RAC. *ARABIAN JOURNAL FOR SCIENCE AND ENGINEERING*, 339–351.
22. *Mi temperature and humidity monitor 2*. Mi Pakistan. (n.d.). Retrieved March 12, 2023, from <https://www.mi.com/pk/product/mi-temperature-and-humidity-monitor-2/specs>
23. Midgley, T., Jr, Henne, A. L. Organic fluorides as refrigerants Ind Eng Chem (1930) 22 542
24. Moran, M. J., & Shapiro, H. N. (2010). *Fundamentals of Engineering Thermodynamics*. Wiley.
25. Orhan, B. (2007). *Aile Tipi Hava Kaynaklı Isı Pompalı Su Isıtıcısı Termodinamik Analizi ve Tasarımı* (thesis).
26. Protection of Stratospheric Ozone: Change of Listing Status for Certain Substitutes Under the Significant New Alternatives Policy Program (2015).

27. Radermacher, R., & Kim, K. (1996). Domestic refrigerators: Recent developments. *International Journal of Refrigeration*, 19(1), 61–69. [https://doi.org/10.1016/0140-7007\(95\)00069-0](https://doi.org/10.1016/0140-7007(95)00069-0)
28. Regal RGL 90 BT/ BT 1001 Büro Tipi Buzdolabı. A101. (n.d.). Retrieved March 12, 2023, from <https://www.a101.com.tr/elektronik/regal-rgl-90-bt-bt-1001-buro-tipi-buzdolabi/>
29. Roider, R. F., Timmerman, H. W. (1948). The two-temperature refrigerator - design and construction *Refrigeration Eng* 134-136
30. Schafer, L.A., 2000, Single Pressure Absorption Heat Pump Analysis, Ph.D.Thesis, Georgia Institute of Technology, 176p
31. Shen, B., Gluesenkamp, K., Bansal, P., & Beers, D. (2016). International Refrigeration and Air Conditioning Conference (pp. 1–9). Purdue University.
32. Singer, W. F. Refrigerating apparatus U.S. Patent No. 577.328 (1897)
33. *Specific heat latent heat of fusion - NASA*. (n.d.). Retrieved March 11, 2023, from <https://spacemath.gsfc.nasa.gov/planets/92Mod11Prob2.pdf>
34. Stoecker W.F., Jones J.W., 1982, Refrigeration and Air Conditioning, McGraw Hill Book Company, Singapore,
35. Y. A. Çengel and M. A. Boles, Thermodynamics an Engineering Approach Fifth Edition, McGraw-Hill, 2006
36. T.C. Millî Eğitim Bakanlığı. (2014). 1.7. Genleşme Elemanının Görevi ve Çeşitleri. *Tesisat Teknolojisi ve İklimlendirme Alanı Montaj Kabini Hazırlama* (pp. 18–21). Essay.
37. Thornton, B., & Wagner, A. (2012). (rep.). *Variable Refrigerant Flow Systems*. General Services Administration By Pacific Northwest National Laboratory.
38. Tokat, A. İ. (2012). Askı Tipi Çamaşır Kurutma Makinesi Tasarımı, Prototipi ve Test Edilmesi, 40–47.
39. Turiel, I., Heydari, A. Analysis of design options to improve the efficiency of refrigerator-freezers and freezers *ASHRAE Trans* (1988) 94 1699-1712
40. Weewell. (2017). *WWD700 Digital Baby Scale*.
41. Why and Where Mold Grows. (n.d.). Retrieved March 11, 2023, from [https://www.epa.gov/mold/mold-course-chapter-2#:~:text=Indoor%20relative%20humidity%20\(RH\)%20should,as%20cockroaches\)%20and%20dust%20mites.](https://www.epa.gov/mold/mold-course-chapter-2#:~:text=Indoor%20relative%20humidity%20(RH)%20should,as%20cockroaches)%20and%20dust%20mites.)
42. Zajaç, A. (2019). Use of waste heat recovery from refrigeration system in a commercial facility – A case study. *E3S Web of Conferences*, 116, 00103. <https://doi.org/10.1051/e3sconf/201911600103>

APPENDICES

APPENDIX 1 PROPERTIES OF THERMOMETER



Basic Specs

Product model no.	LYWSD03MMC
Product materials	ABS, PMMA
Battery model	CR2032 (installed)
Temperature measurement range	0°C–60°C
Humidity measurement range	0%–99% RH
Standards	QB/WSDJ 2401–2019
CMIIT ID	2019DP8115
Product dimensions	43*43*12.5 mm
Operating voltage	DC2.5V–3V
Wireless connection	Bluetooth 4.2 BLE
Temperature display resolution	0.1°C
Humidity display resolution	1% RH

Table 4. Properties of Temperature and Humidity Sensor (Mi, 2023)

Their operation ranges include the experiment conditions. Temperature accuracy is 0.1 °C and humidity accuracy is 1%, so sensors are very accurate for the experiment. In addition, they have memory storage for historical data. Thanks to this feature, temperature, and humidity values are collected. Moreover, they are able to send humidity and temperature information via Bluetooth technology.

APPENDIX 2 DETAILED DRAWINGS

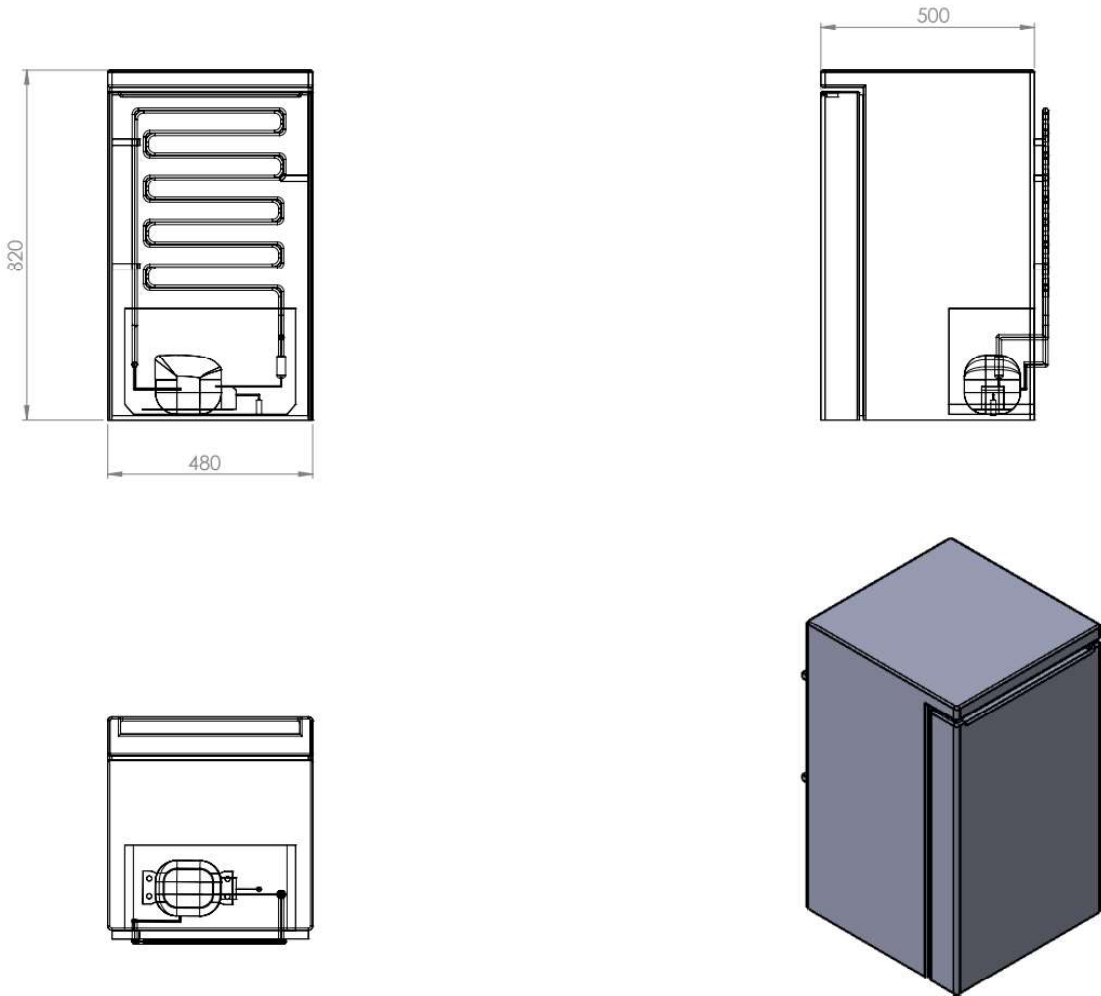

Figure 1 Refrigerator chamber dimensions (Regal, 2023)

Long, wide, and high are 0,5m, 0,48m, and 0,82m respectively. It can be taken as 6 main surfaces since the compressor compartment has a rectangular prism shape. In the frame of the experimental setup and test steps, drawings are made with the use of Solidworks as 3D CAD software. Drawings and dimensions are given below:

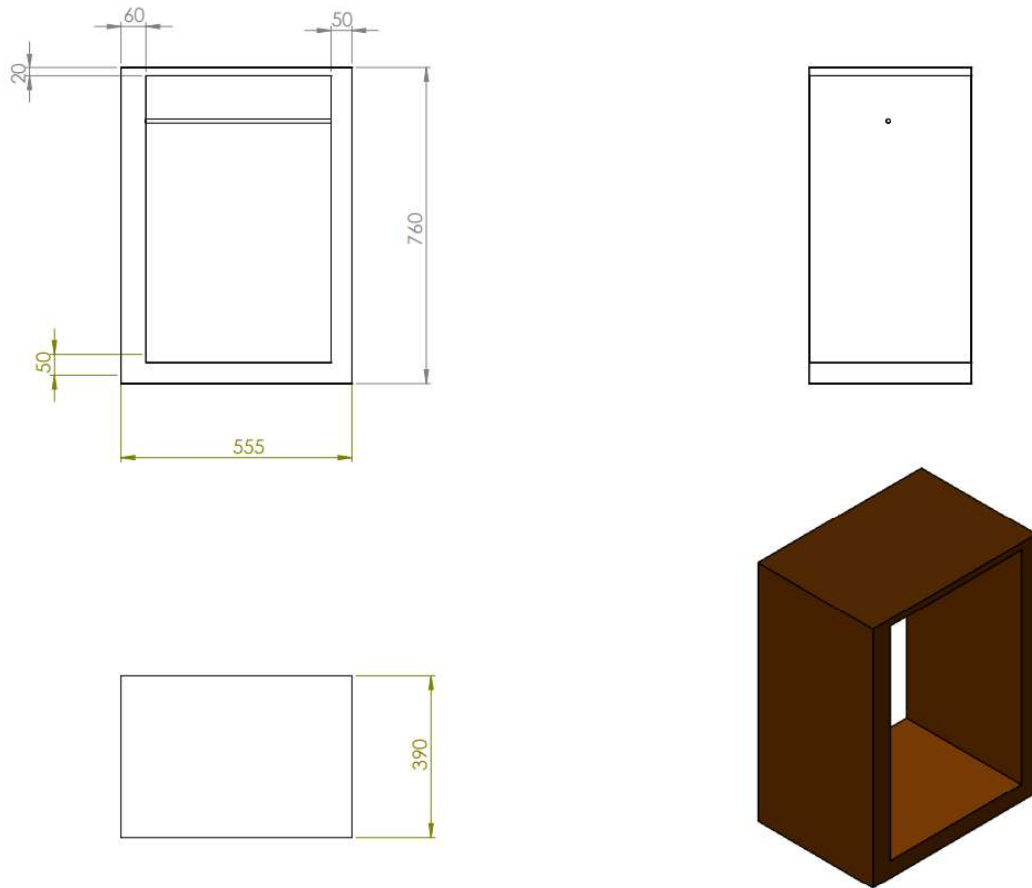

Figure 2 Clothes Dryer Chamber Dimensions

Figure 2 shows the walls, roof, and floor insulation of the chamber. For insulation purposes, spray polyurethane with $0.03 \text{ W}\cdot\text{m}^{-1}\cdot\text{K}^{-1}$ is used as shown thickness. Insulation is a job that requires experience and mastery. Thus, it is quite bit hard to have desired thickness for all surfaces. In addition, refrigerator chamber sizes are a limiter for some surfaces such as the upper surface. Above insulation polyurethane layer thicknesses are chosen as the optimum value for this design.

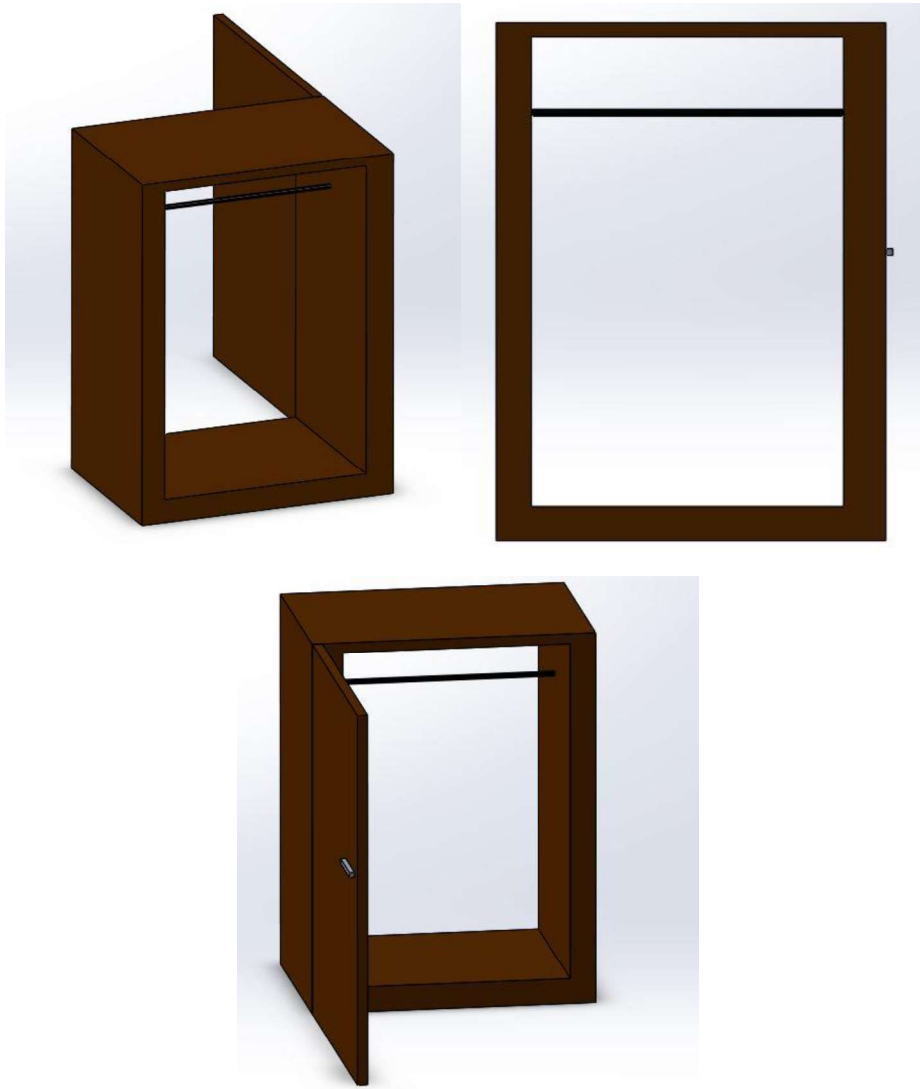

Figure 3 Clothes Dryer Chamber view from different aspects

The view of the clothes dryer chamber from different aspects is given in Figure 3. This setup is used for Test Step 1

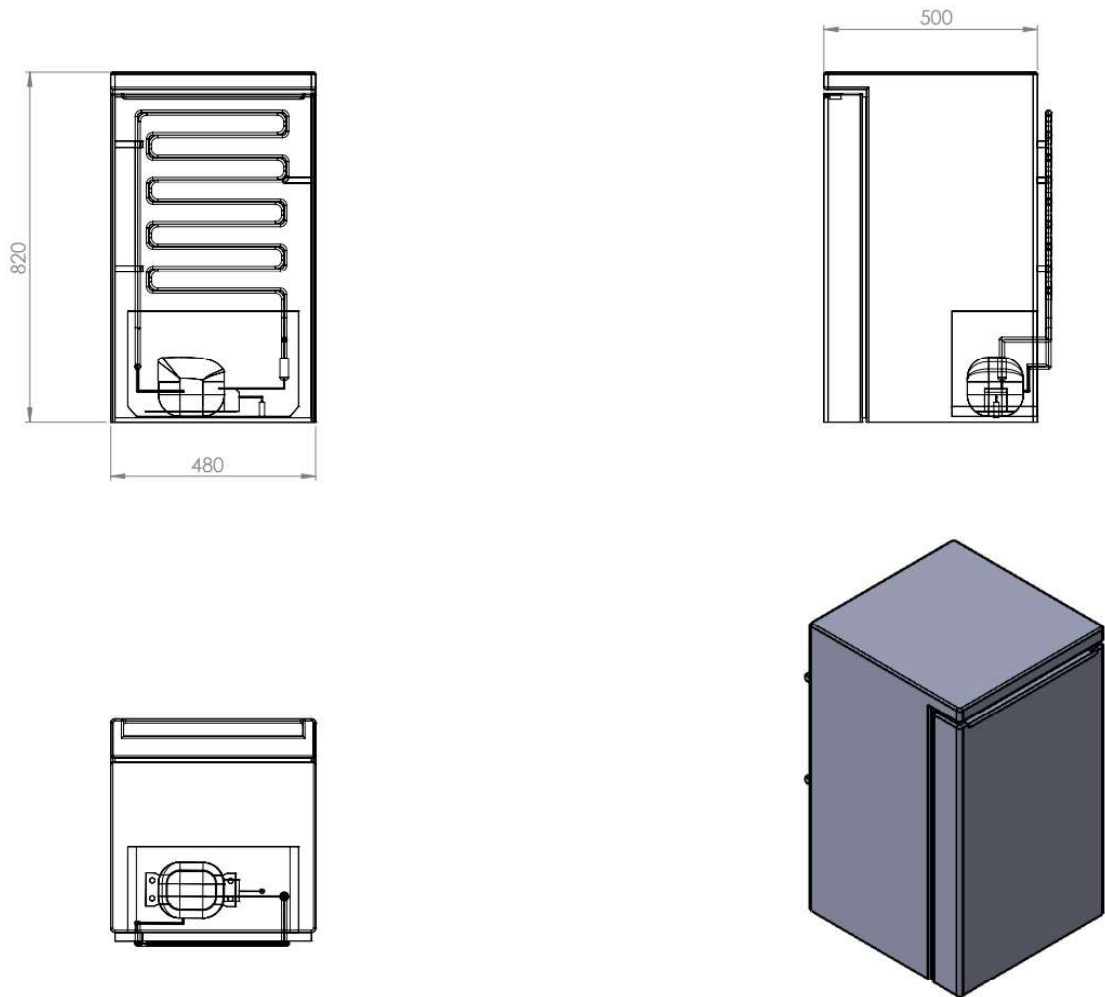

Figure 4 Refrigerator Chamber Dimensions

Figure 4 illustrates refrigerator chamber dimensions. It is a 3D drawn version of the refrigerator defined in Figure 4.1 basically. The compressor sizes are specified from the compressor properties in Appendix 1. This step is used for Step 5.

The refrigerator and clothes dryer chambers, which are shown in Figure 2 and 4 respectively, are assembled in drawings.

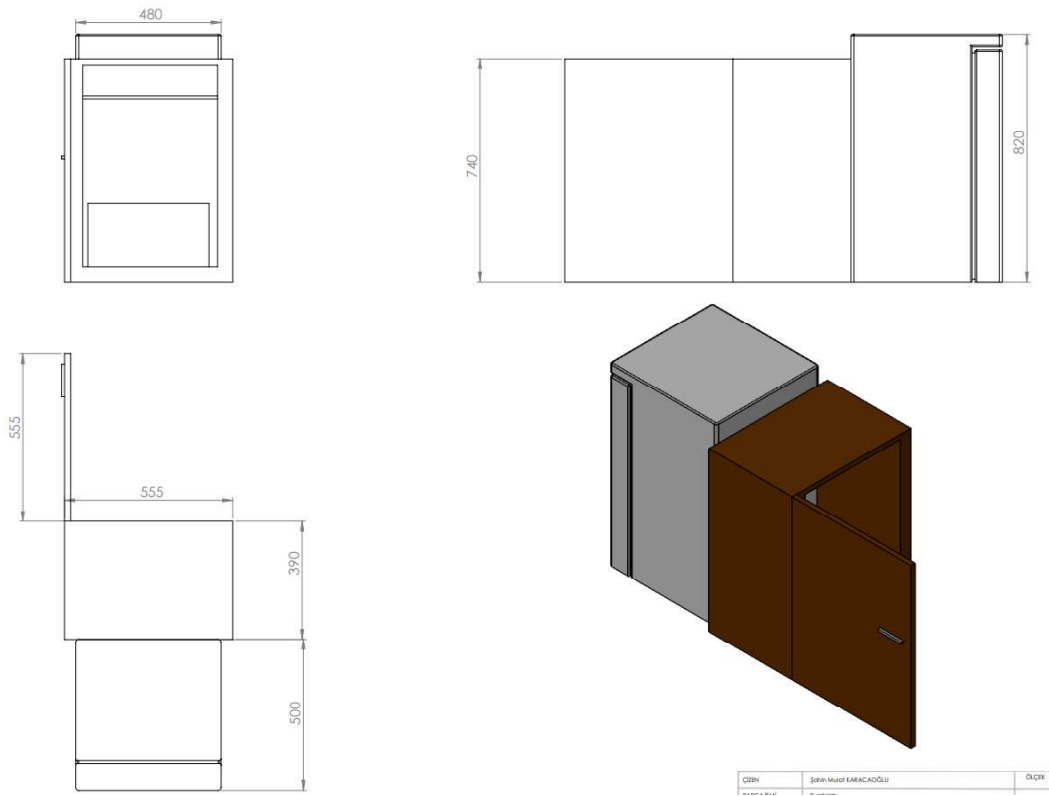

Figure 5. Montage Dimensions

This mechanism is used for Test Step 3, partially for Test Step 6.

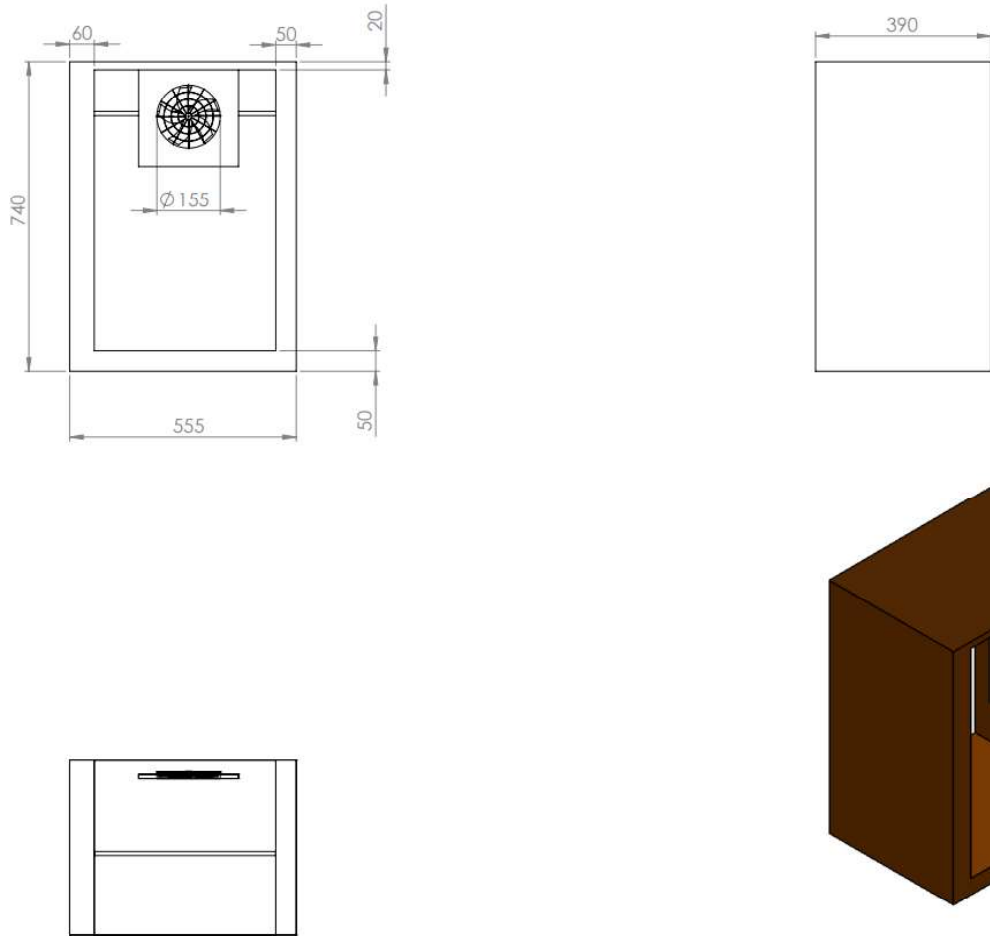
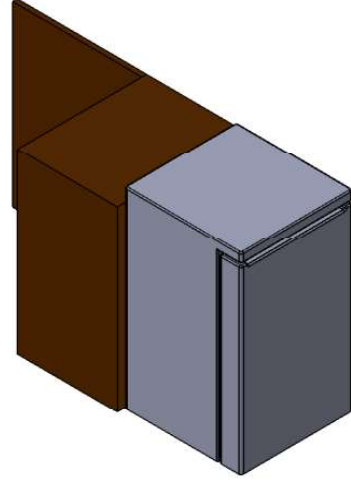
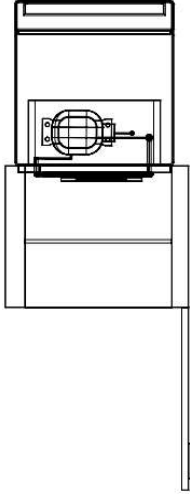
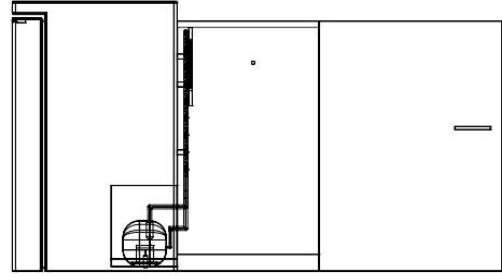
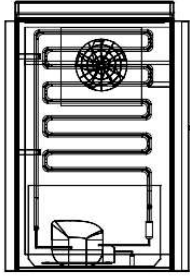

Figure 6 Dimensions of clothes dryer chamber with fan from above

Figure 6 shows the setup for Test Step 2. The dimensions of the chamber and fan are as shown in the figure.



ÇİZİM	SARAY MAHİR KARACAOĞLU
PARÇA İSİMİ	Montaj
TARİHİ	18.02.2023

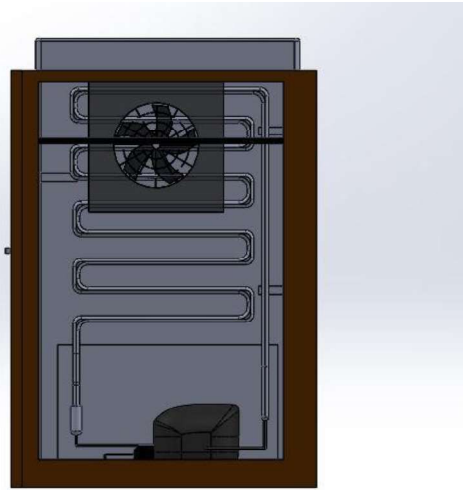
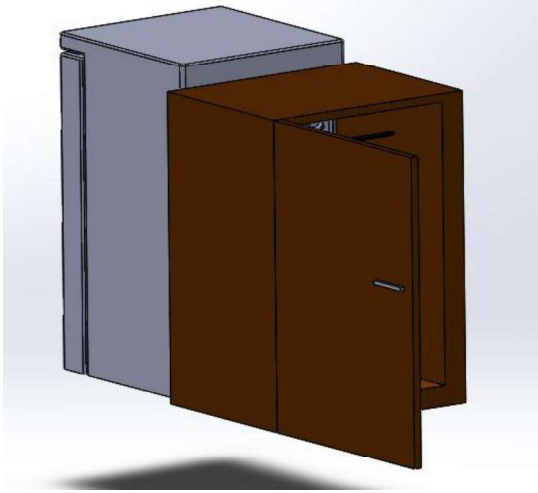



Figure 7 The view from different aspects of fan from above designed system
 Figure 7 is about the experimental setup for Test Step 4.a and Step 6. The fan is assembled above position. The setup helps to determine the most efficient design.

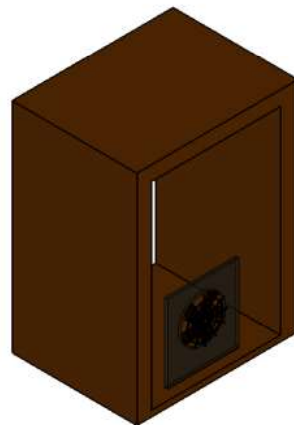
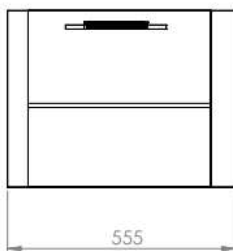
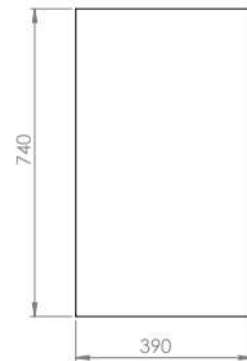
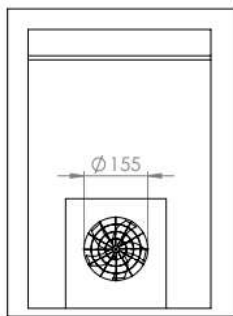
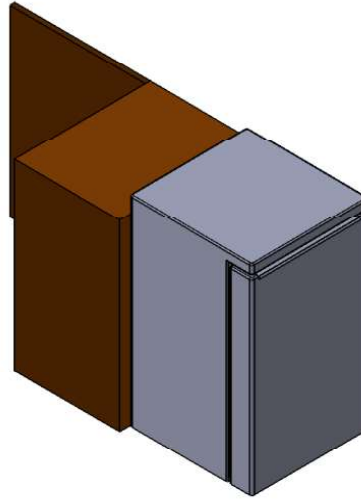
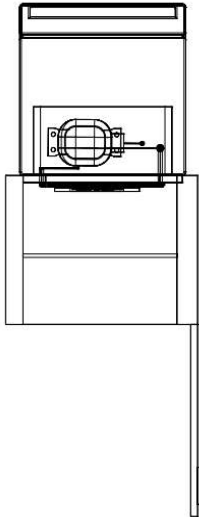
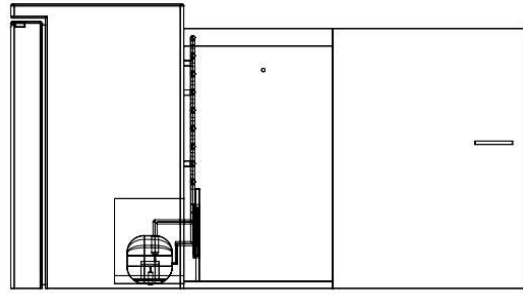
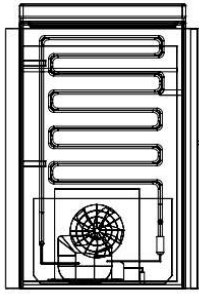

Figure 8 Dimensions of clothes dryer chamber with fan from below



ÇİZEN	Selin Murat KARACAOĞLU	ÖL
PAKÇI BAŞI	Monthip	
TARİH	18.02.2023	1

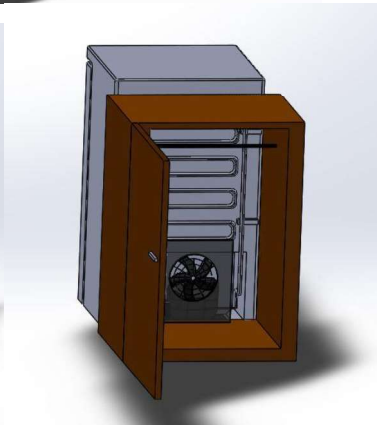
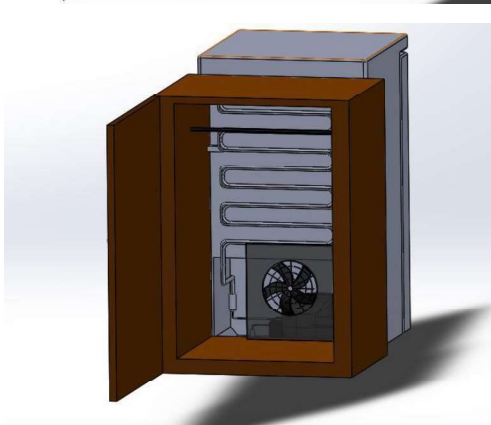
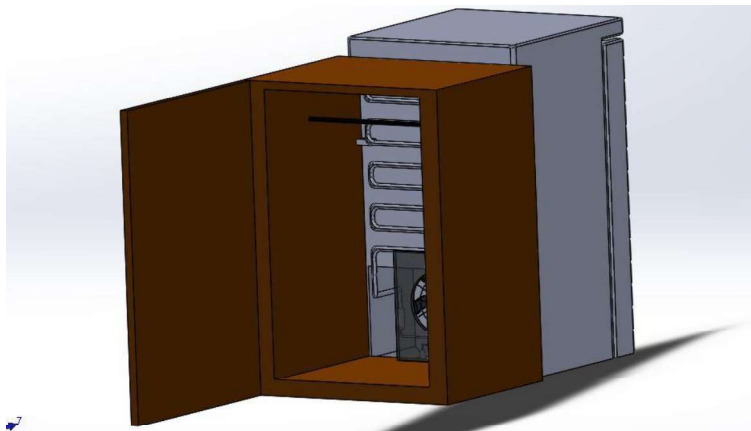

Figure 9 The view from different aspects of fan from below designed system

Figures 8 and 9 show fan from below designed heat pump system. It is used for Test Step 4.b and for Step 6.

**APPENDIX 3 - THE GENERAL VIEW OF THE PRODUCED EXPERIMENTAL
SETUP, SENSOR AND DEVICE AND LOAD PLACING**



Figure 1. General view of the device



Figure 2.. 20,5 L + 3 L water and temperature sensor placing



Figure 3. Insulated clothes dryer chamber with fan from above

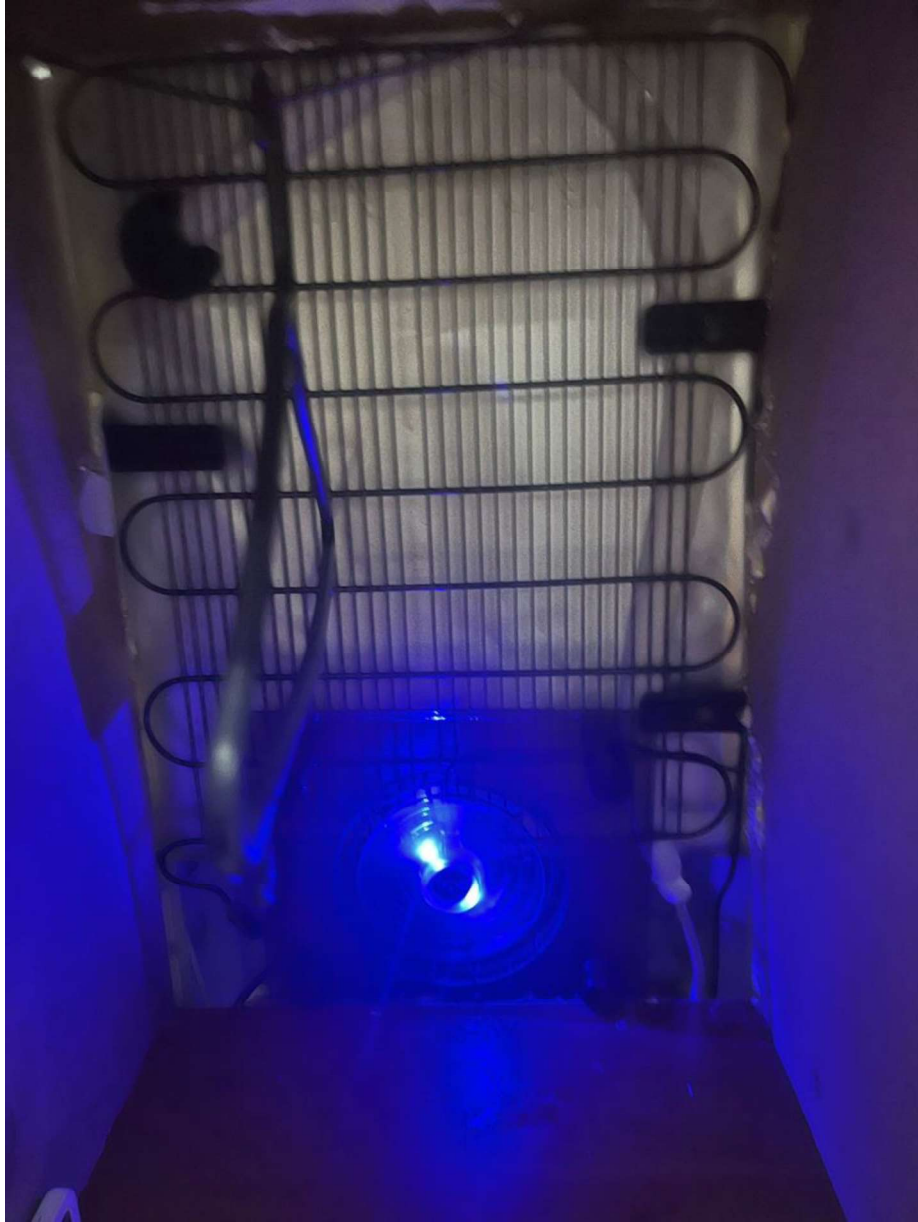

Figure 4. Looking from the door of the insulated clothes dryer chamber with fan from below position

APPENDIX 4 – EXPERIMENTAL STEP 5 REFRIGERATOR INSIDE TEMPERATURE AND RELATIVE HUMIDITY VALUES

Table 1 Inside temperature and humidity data of refrigerator chamber without clothes dryer chamber

	Date	Hour	Temperature (°C)	Humidity (RH)	Temperature Difference per 1 hour
	Day 1	12:21	23,7	44	
	Day 2	16:16	4,8	13	
1	Day 1	13:00	23,6	69	-0,2
2		14:00	23,8	59	5,5
3		15:00	18,3	29	1,4
4		16:00	16,9	22	0,9
5		17:00	16	18	0,9
6		18:00	15,1	17	0,8
7		19:00	14,3	16	0,6
8		20:00	13,7	15	0,6
9		21:00	13,1	15	0,5
10		22:00	12,6	25	-1,4
11		23:00	14	19	2,1
12	Day 2	00:00	11,9	13	0,7
13		01:00	11,2	13	0,6
14		02:00	10,6	13	0,5
15		03:00	10,1	13	0,4
16		04:00	9,7	13	0,4
17		05:00	9,3	13	0,4
18		06:00	8,9	13	0,5
19		07:00	8,4	13	0,4
20		08:00	8	13	0,3
21		09:00	7,7	13	0,4
23		11:00	7	13	0,3
24		12:00	6,7	13	0,4
25		13:00	6,3	13	0,3
26		14:00	6	13	0,3
27		15:00	5,7	13	0,3
28		16:00	5,4	13	0,3
29		17:00	5,1	13	-

Table 2 Inside temperature and humidity data of refrigerator chamber with clothes dryer chamber

Date	Temperature (°C)	Humidity (RH)
Day 1 23:26 Start	24,5	34
Day 3 10:14 Finish	4,6	11

	Date	Hour	Temperature (°C)	Humidity (RH)	Temperature Difference
1	Day 1	23:00	24,1	35	-0,3
2	Day 2	00:00	24,4	38	0,1
3		01:00	24,3	39	3,8
4		02:00	20,5	19	1,4
5		03:00	19,1	16	0,8
6		04:00	18,3	14	0,9
7		05:00	17,4	13	0,9
8		06:00	16,5	13	0,9
9		07:00	15,6	12	0,9
10		08:00	14,7	12	0,6
11		09:00	14,1	12	0,6
12		10:00	13,5	12	0,5
13		11:00	13	12	0,6
14		12:00	12,4	12	0,4
15		13:00	12	21	0,7
16		14:00	11,3	12	0,4
17		15:00	10,9	11	0,4
18		16:00	10,5	11	0,5
19		17:00	10	11	0,4
20		18:00	9,6	11	0,4
21		19:00	9,2	11	0,4
22		20:00	8,8	11	0,3
23		21:00	8,5	11	-0,1
24		22:00	8,6	26	0,8
25		23:00	7,8	12	0,4
26		00:00	7,4	11	0,2
27	Day 3	01:00	7,2	11	0,2
28		02:00	7	11	0,2
29		03:00	6,8	11	0,2
30		04:00	6,6	11	0,3
31		05:00	6,3	11	0,3
32		06:00	6	11	0,2
33		07:00	5,8	11	0,2
34		08:00	5,6	11	0,2
35		09:00	5,4	11	0,3
36		10:00	5,1	11	-

Table 3. Inside temperature and humidity data of refrigerator chamber with clothes dryer chamber and fan (below)

Date		Temperature (°C)		Humidity (RH)	
Day 1 23:26 Start		24,5		34	
Day 3 10:14 Finish		4,6		11	
	Date	Hour	Temperature (°C)	Humidity (RH)	Temperature Difference per 1 hour
1	Day 1	23:00	24,7	68	1,5
2	Day 2	00:00	23,2	37	6
3		01:00	17,2	22	-

Table 4. Temperature and humidity data of heat pump used cases

	Fan	Heat Pump	Time (hour)	Weight Difference (g)	T1	RH1	T2	RH2
Step 3		X	07:21	255	29,1	40	28,2	51
Step 4a	X (above)	X	04:55	300	26,2	45	31,1	36
Step 4b	X (below)	X	03:38	320	27	57	31,2	50
Additional case		X	01:00		28,5	41	55	27

APPENDIX 5 - THESIS/DISSERTATION ORIGINALITY REPORT

Şablona uygun olarak hazırlanan “Orijinallik Raporu”nun imzalı hali bu bölümde verilmelidir.

