



HACETTEPE UNIVERSITY, GRADUATE SCHOOL OF SOCIAL SCIENCES

DEPARTMENT OF TRANSLATION AND INTERPRETATION

**EFFECT OF WORKING MEMORY TRAINING ON
SIMULTANEOUS INTERPRETING PERFORMANCE:
DUAL N-BACK TASK**

BUSE SAKALLI

MASTER'S THESIS

ANKARA, 2015

EFFECT OF WORKING MEMEORY TRAINING ON SIMULTANEOUS
INTERPRETING PERFORMANCE: DUAL N-BACK TASK

Buse Sakallı

Hacettepe University, Graduate School of Social Sciences

Department of Translation and Interpretation

Master's Thesis

Ankara, 2015

KABUL VE ONAY

Buse Sakallı tarafından hazırlanan "EFFECT OF WORKING MEMORY TRAINING ON SIMULTANEOUS INTERPRETING PERFORMANCE: DUAL N-BACK TASK (ÇALIŞMA BELLEĞİ EĞİTİMİNİN ANDAŞ ÇEVİRİ BAŞARIMI ÜZERİNDEKİ ETKİSİ: İKİLİ N-GERİ UYGULAMASI)" başlıklı bu çalışma, 14/01/2016 tarihinde yapılan savunma sınavı sonucunda başarılı bulunarak jürimiz tarafından Yüksek Lisans Tezi olarak kabul edilmiştir.

[İ m z a]

Yrd. Doç. Dr. Evren Alpaslan (Başkan)

[İ m z a]

Prof. Dr. Aymil Doğan (Danışman)

[İ m z a]

Yrd. Doç. Dr. Elif Ersöz

[İ m z a]

Yrd. Doç. Dr. Özlem Şahin Soy

[İ m z a]

Yrd. Doç. Dr. Zeynep Avcı Doyuran

Yukarıdaki imzaların adı geçen öğretim üyelerine ait olduğunu onaylıyorum.

Prof.Dr.Berrin KOYUNCU LORASDAĞI

Enstitü Müdürü

BİLDİRİM

Hazırladığım tezin/raporun tamamen kendi çalışmam olduğunu ve her alıntıya kaynak gösterdiğimi taahhüt eder, tezin/raporumun kağıt ve elektronik kopyalarının Hacettepe Üniversitesi Sosyal Bilimler Enstitüsü arşivlerinde aşağıda belirttiğim koşullarda saklanmasına izin verdiğimi onaylarım:

- Tezin/Raporumun tamamı her yerden erişime açılabilir.
- Tezim/Raporum sadece Hacettepe Üniversitesi yerleşkelerinden erişime açılabilir.
- Tezin/Raporumun 3 ay süreyle erişime açılmasını istemiyorum. Bu sürenin sonunda uzatma için başvuruda bulunmadığım takdirde, tezin/raporumun tamamı her yerden erişime açılabilir.

14/01/2016

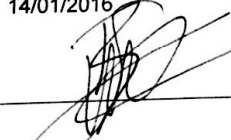
Buse Sakallı

ACKNOWLEDGMENTS

I owe thanks to a great many people who provided encouragement, wisdom, and patience for this study. The completion of this project would not have been possible without the support and friendship of some special people. First of all, heartfelt thanks to my parents, Sevcan and Osman Sakallı for their never-ending support. I might have never found the encouragement enough to reach this terminus ad quem of mine without them backing me up.

Heartfelt thanks to my dearest life partner, Samet Kölgesiz, for his endless love, support and faith in me.

Gratitude and utmost respect to my dear advisor, Prof. Aymil Doğan, for all her guidance and contributions from beginning to the end, always inspiring me with her firm stand on work ethics. I especially want to thank her for designing the “Simultaneous Interpreting Laboratory” at the Department of Translation & Interpretation and thus giving me and many other students the chance of studying in a modern and accoutred laboratory.

Special gratitude and the highest regard to Dr. Mark Ashton Smith for his sincere attitude towards this study by providing us a great deal of data regarding the “dual n-back training software” and leading us through the procedures of the application process.

Many thanks from the bottom of my heart to Dr. Sakine Göçer who provided me a great help considering the data analysis methods. I was able to complete a part of this work only with her friendly guidance.

ÖZET

SAKALLI Buse, *Çalışma Belleği Eğitiminin Andaş Çeviri Başarımı Üzerindeki Etkisi: İkili N-Geri Uygulaması*, Yüksek Lisans Tezi, Ankara, 2015

Andaş çeviri, çevirmenin gelen mesajı çözmek ve hedef dilde eşdeğer bir söylem üretebilmek üzere tekrar kodlayabilesi için bir dilden diğer dile sürekli olarak geçiş yapabilmesini gerektirir. Andaş çeviri edimi zihinsel çoklu görev, bilgi güncelleme, görevler arası değişim yapabilme, aynı anda ve anında bilgi işlemleyebilmenin yanısıra ileri düzey ikidilli bilişsel becerilerin edinilmesini zorunlu kılar. Tüm bu becerilerin altında bilginin işleme esnasında durmaksızın güncellenmesi yatmaktadır. Dolayısıyla, bu süreç en başta bilginin güncellenmesine katkısıyla bilinen çalışma belleği kapasitesi üzerinde aşırı yük oluşturmaktadır. Bu çalışmada çalışma belleği eğitiminin andaş çeviri başarımı üzerindeki etkisi tek grup öntest sontest modelinde araştırılmıştır. “İkili N-Geri” görevi, temel olarak, gelen bilginin güncellenmesine dayanır ve faydaları bir çok bilimsel çalışma tarafından onaylanmıştır. Elde edilen sonuçlar ışığında, ikili n-geri görevinin çalışma belleği kapasitesinin geliştirilmesine bağlı olarak katılımcıların andaş çeviri başarımı üzerinde açık bir artışa sebep olduğu sonucuna varılmıştır. Sonuçlar aynı zamanda çalışma belleği kapasitesinin gelişmesiyle, öğrencilerin sıralı olayları, sözcüksel ve rakamsal bilgileri daha kolay hatırlayabildiğini ortaya koymaktadır. Sonuç olarak, bilişsel bilim ve andaş çeviri alanlarında yürütülecek ortak çalışmaların bilişsel becerilerin daha iyi anlaşılmasına ve böylece andaş çeviri eğitiminin geliştirilmesine yol açacağı savunulmuştur.

Anahtar Kelimeler: Andaş Çeviri, ikili n-geri, çalışma belleği, ileri düzey bilişsel beceriler

ABSTRACT

SAKALLI Buse, *Effect of Working Memory Training on Simultaneous Interpreting Performance: Dual N-Back Task*, Master Thesis, Ankara 2015

Simultaneous interpretation requires the act of switching continuously from one language to another while decoding and simultaneously encoding the entering message to generate an equivalent discourse in the target language. The process of interpreting in simultaneous mode is realized with many higher-order cognitive skills such as multi-tasking, updating, switching and concurrent information processing skills as well as advanced bilingual language skills. All of these skills underline the need to constantly update the incoming information and thus overload the working memory capacity as working memory is well known to be engaged in updating information during the ongoing information processing. In this study, the effect of working memory training through dual n-back task on simultaneous interpreting performance was investigated through a single group pre-test post-test design. Dual n-back task is mainly based on the notion of updating the incoming information and its benefits have been confirmed by a considerable number of scientific studies. Following the results of this study, it was concluded that dual n-back task clearly enhanced the simultaneous interpreting performance of the participants due to the increase of their working memory capacity. The data also revealed that as the working memory capacity improved, the ability of students to recall lexical items, sequential events and figures was also enhanced. It was suggested that further interaction of cognitive science and simultaneous interpretation would lead to the better comprehension of cognitive abilities and thus the improvement of simultaneous interpretation training.

Keywords: Simultaneous Interpreting, dual n-back, working memory, higher-order cognitive skills

Table of Contents

KABUL VE ONAY	i
BİLDİRİM	ii
ACKNOWLEDGMENTS	iii
ÖZET	iv
ABSTRACT	v
Table of Figures	ix
List of Tables	x
 CHAPTER 1	
INTRODUCTION	1
1.1. GENERAL FRAMEWORK OF THE STUDY	1
1.1.1. Importance and Aim of the Study	2
1.1.2. Research Questions.....	3
1.1.3. Assumptions	4
1.1.4. Limitations	4
1.1.5. Delimitations	4
1.1.6. Definitions.....	4
1.1.7. Outline of the Study.....	6
1.2. SIMULTANEOUS INTERPRETING AND MUTIDISCIPLINARITY	7
1.3. WORKING MEMORY- THE RAM(rapid access memory).....	11
1.4. DUAL N-BACK TASK IN PRACTICE	14
1.5. SCOPE OF THE STUDY	15
 CHAPTER 2	
STATE OF ART	17
2.1. INTERDISCIPLINARITY	17
2.1.1. Different Dimensions of the “Process”	21
2.2. EARLY STAGES OF THE DEVELOPMENT	23
2.3. SIMULTANEOUS INTERPRETATION INTERSECTING COGNITIVE SCIENCE.....	27

2.3.1. Recent Explorations on Interpreting Studies	32
2.4. PROCESS MODELS OF SIMULTANEOUS INTERPRETATION	40
2.4.1. Gerver’s Model of Simultaneous Interpretation	41
2.4.2. Moser’s Model of the Simultaneous Interpretation Process.....	44
2.4.3. Gile’s Effort Model	46
2.4.4. Process Model by Valeria Daro and Franco Fabbro.....	48
2.5. WORKING MEMORY	50
2.5.1. Capacity and Importance of Working Memory	54
2.5.2. Training of Working Memory	57
2.5.3. General Benefits of WM Training	59
2.6. WORKING MEMORY IN SIMULTANEOUS INTERPRETATION	63
2.7. DUAL N-BACK TASK.....	68
CHAPTER 3	
METHODOLOGY	74
3.1. RESEARCH METHODOLOGY AND RESEARCH DESIGN	74
3.2. PARTICIPANTS- POPULATION AND SAMPLE	75
3.3. PROCEDURE	75
3.3.1. Preliminary Studies	76
3.3.2. Experimental Study.....	81
3.3.3. Data Collecting Instruments	84
3.3.4. Data Analysis Methods	90
CHAPTER 4	
RESULTS.....	92
4.1. WILCOXON SIGNED-RANKS TEST	92
4.2. SPEARMAN BROWN RANK ORDER CORRELATION.....	98
4.3. QUESTIONNAIRE	100
CHAPTER 5	
DISCUSSION.....	102
5.1. SUMMARY OF THE RESULTS.....	101
5.2. EVALUATION IF THE RESULTS.....	102
5.3. QUESTIONNAIRE	106

CONCLUSION.....	108
REFERENCES.....	111
APPENDIX 1. PRE-TEST PASSAGES.....	133
APPENDIX 2. POST-TEST PASSAGES.....	139
APPENDIX 3. QUESTIONNAIRE.....	145
APPENDIX 4. VOCABULARY LIST FOR PRE-TEST.....	149
APPENDIX 5. VOCABULARY LIST FOR POST-TEST	152
APPENDIX 6. ETHICS BOARD WAIVER FORM FOR THESIS WORK.....	156
APPENDIX 7. THESIS/DISSERTATION ORIGINALITY REPORT.....	157

Table of Figures

Figure 1. Regions in which authors found longitudinal evidence for brain structural plasticity in simultaneous language interpreters (Hervais-Adelman et al. 2011:4).....	35
Figure 2. Significant differences in activation levels in 34 non-experts, rendered on canonical single-subject brain. (HervaisAdelman et al. 2011: 4).....	35
Figure 3. Significant differences in BOLD response for the contrasts Shadowing > passive listening and simultaneous interpreting>shadowing (Golestani & Mercer 2014).....	39
Figure 4. Gerver’s Simultaneous Interpretation Model (1975).....	42
Figure 5. A processing model of SI (Moser 1978; Moser-Mercer 1997)	45
Figure 6. A general model of memory during SI (Daro & Fabbro 1994).....	49
Figure 7. The multi-component working memory model (Baddeley, 2000)	53
Figure 8. Connections of Working Memory (from BrainScann).....	55
Figure 9a. Brain regions underlying interference control, working memory capacity and Gf, Burgess (2011).....	60
Figure 9b. Increases in frontal and parietal activity after training of WM (Olsen et al., 2004)	60
Figure 10. Standard Dual N-Back Task by IQMindware	69
Figure 11. Cortical Areas of Working Memory by Killenberg (2002).....	70
Figure 12a. Neuroplasticity inducing training method by HighIQPro	72
Figure 12b. WM as a common unit for Dual N-Back task and Simultaneous Interpretation	73
Illustration 1. An illustration of the visual 2 n-back	83

List of Tables

Table 1. Summary of the literature by Signorelli & Obler, 2014.....	64-65
Table 2. One Group Pretest-Posttest Design.....	74
Table 3. Kuder & Richardson Formula 20 for the Internal Consistency of Pre-test Questions	86
Table 4. K&R Formula 20 for Internal Consistency of Post-test Questions.....	87
Table 5. Spearman Brown Rank Order Correlation between the dual n-back levels and post-test scores of 20 participants	99

CHAPTER 1

INTRODUCTION

This chapter will dwell on drawing the general framework, together with the streamline of the study, indicating the overall content and scope of each title. Basic concepts such as simultaneous interpreting, working memory (WM) and dual n-back training will also be depicted as they are the core aspects of the basis of this study. Additionally, the importance and aim of the study as well as the research question and sub questions which shaped the steps followed in this study will be reviewed. These descriptions will be followed by the assumptions, limitations and the definition of the operational terms in question and finally an outline of the study will be given as a frame of the general outlook of the study.

1.1. GENERAL FRAMEWORK OF THE STUDY

This study investigates the effects of working memory training on the simultaneous interpreting performances of interpreting students at Hacettepe University, Ankara. Students exercised the dual n-back training task for two months and a “one group pre-test post-test design” experiment was carried out in the laboratory environment conditions of the Department of Translation & Interpretation to see if the training yields any improvement in their general interpreting competence. The results shed light to the wide transfer effect of the working memory training by illustrating a significant increase in the interpreting skills of participants. Depending on the data gathered, it can be concluded that exercising working memory training task regularly might have a paramount impact on the development of the skills required for professional interpreting. In other words, it might be precipitated that improving the WM capacity leads to a better coordination of attentional control and other cognitive functions such as the elimination of interfering information and multi-tasking which are the building blocks of simultaneous interpretation.

1.1.1. Importance and Aim of the Study

Simultaneous interpreting is a complex bilingual verbal activity that involves the auditory perception of an oral input and the generation of a coherent discourse and this process often leads to cognitive overload. Yet, recent research has underlined that becoming an expert in a field may lead to a transfer of the acquired skills to other domains requiring similar abilities (Klingberg et al., 2009). Likewise, the cognitive skills acquired by professional interpreters after intensive training may also transfer to other domains. Many researchers from cognitive science, psychology, educational psychology and neuroscience focused on investigating the effects of simultaneous interpreting on cognitive functioning and they found that interpreters tend to be able to coordinate a better working memory updating as well as ability to ignore the interfering information, coping with the articulatory suppression effect and better perform multi-tasking (Christoffels et al. 2006, Tzou et al. 2011, Signorelli 2012,). Such skills depend on working memory's capacity to store or process information and they determine the simultaneous interpreting performance of interpreters.

Professional interpreters are trained to master the ability to store and process any incoming verbal information for a limited period of time and they are presumed to possess better working memory skills than non-interpreters. Nevertheless, although the professional interpreters have years-long experience, they even may have difficulty in producing an output whereas no distracting factor is identified in the input, which proves the fact that they often seem to work near the saturation level of their cognitive resources. Therefore, improving the capacity of working memory means increasing the quality of the output for an interpreter and any training procreating a better result in this sense would be a stepping stone in this field. One of the working memory training tasks, dual n-back task, has been recently investigated by many researchers as more and more data accumulated towards the suggestion that this cognitive task causes near and far transfer effects in the brain.

For this reason, this study sets to explore if dual n-back task, based on improving fluid intelligence by information updating and interfering distractions, yields any improvement on the general performances of the simultaneous interpreting students.

The results suggest that training on the dual n-back task may increase the WM capacity in a short period of time and thus enhance the ability of simultaneous interpreting which means that the training may have penetrated into the common neural networks that are commonly shared by the dual n-back task and simultaneous interpreting.

1.1.2. Research Questions

“Is there a significant difference between the pre-test and post-test simultaneous interpreting scores of the participants who received working memory training through dual n-back programme?” The underlying sub questions that feeds this major question are indicated below.

Subquestions

1. Is there a significant difference between the pre-test and post-test simultaneous interpreting performance scores of the participants in terms of recalling capacity of lexical items?
2. Is there a significant difference between the pre-test and post-test simultaneous interpreting performance scores of the participants in terms of recalling capacity of figures?
3. Is there a significant difference between the pre-test and post-test simultaneous interpreting performance scores of the participants in terms of recalling capacity of sequential events?
4. What is the success level of the participants receiving dual n-back training programme?
5. Is there a correlation between the dual n-back levels and the simultaneous interpreting scores of the participants?

Therefore, the study is shaped within the framework of three supportive sub questions that will lead to the answer of the main research question. The flow of the study and the design of the experiment is accordingly constructed to first address these three questions and thus lead to a conclusion for the main question.

1.1.3. Assumptions

1. The participants of the experiment were assumed to be equivalent to each other in terms of the language competence.
2. The participants were assumed to have been affected from the laboratory conditions in the same way and to the same extent.
3. The participants were assumed to have fulfilled the requirements of the experimental tasks sincerely making maximum effort.

1.1.4. Limitations

1. The results of the study was limited with the 3rd year students of the Translation & Interpretation Department of Hacettepe University, Ankara. They all had beginner level interpreting skills and they all had one-semester introduction to interpreting courses before the study was started.
2. The participants of the study was also limited with the students at English section.

1.1.5. Delimitations

The study included both male and female 3rd year students of the Translation and Interpretation Department of Hacettepe University.

1.1.6. Definitions

The operational terms used in this study are defined below in order to avoid any ambiguity concerning the content of the issues relevant.

Simultaneous Interpretation: Listening to a message in one language and rendering that message verbally into another language within one or two seconds, while at the same time listening to the incoming message.

Working Memory: Limited capacity system that includes a short-term storage of information and the functions of updating and manipulating the storage contents. (Salminen, Strobach & Schubert, 2012:23)

Dual N-back Training: A working memory training exercise where verbal auditory stimulus and spatial visual stimulus are presented at the same time and the person needs to remember the n previous auditory and visuo-spatial stimuli separately.

Lexical item: In this study, this term refers to a term, word or a chain of words that acts as a unit of meaning (as defined by Lederer, 1978) embedded in the pre-test and post-test passages as test materials.

Figure: A number or numeral used as an item embedded in the pre-test and post-test passages as test materials to measure the ability of students to recall numeric data.

Sequential Events: A series of arbitrarily-ordered episodes which are embedded in the pre-test post-test passages as test materials to measure the ability of students to recall incidents.

Chunking: A processing strategy in interpreting and working memory which relates to the smallest meaningful unit in the presented material that a person can recognize and considered as detrimental because this strategy decreases the cognitive load required for the task and the brain no longer learns.

Fluid Intelligence (Gf): Ability to think and reason abstractly and solve problems regardless of the previous experience and knowledge relevant. (Catell, 1987)

fMRI: Functional magnetic resonance imaging is a functional neuroimaging procedure using MRI technology that measures brain activity by detecting changes associated with blood flow (Huettel, Song & McCarthy, 2009)

Priming: The technique that investigates the influence of one stimulus (the prime) on the processing of another stimulus that is presented subsequently (the target). (Spivey et al., 320)

1.1.7. Outline of the Study

Under the first chapter, simultaneous interpreting is evaluated within different scientific disciplines in a descriptive way and its increasing prominence to this end is underlined. Then a summary for the definition and known functions of working memory is provided and this is followed by the introduction of the dual n-back task and its cognitive benefits which are claimed to show near and far transfer effects. Finally a more detailed explanation for the essential aim and scope of this study is provided with the final results reached at the end.

Second chapter encompasses the historical flow of each basic discipline mentioned above as three main titles to help the reader follow the developments related to them such as theories and models coming out in due course. In other words, the crucial data accumulated up to date considering the working memory and simultaneous interpretation are provided in detail. Dual n-back task a WM training method is also underlined.

Third chapter dwells on the explanation of the research design and the statistical analyses carried out. In addition, preliminary studies, the content of the experiment and the data collecting instruments is explained in detail.

Fourth chapter covers the data collected from the statistical analyses carried out and they are interpreted within the framework of the concept in chapter five. The initial aim and expectations concerning this study are assessed together with the results reached at the end and the significance of the results are evaluated in terms of the data currently present in the fields of working memory training and simultaneous interpretation.

The general aim of the study and an overall report of the results are indicated in the last chapter with some suggestions for further research.

1.2. SIMULTANEOUS INTERPRETING AND MULTIDISCIPLINARITY

Simultaneous interpreting (SI) has been a profession which is familiar to most of the people working in different segments of social life such as academia, business, diplomatic and commercial life. It is also used in media where live international conventions or interviews in today's polycultural world of high technology are broadcast. At this utmost point of civilization, it is of great significance to realise the cognitive and physical processes related to this demanding act which brings different multilingual minds together by eliminating vernacular barriers any time at any place.

The continuous and immediate task of listening to a message in the source language (SL) and conveying it into the target language (TL) orally is named as "simultaneous interpretation". This action takes place while the interpreter sits in a sound-proof booth equipped with control consoles and generally a computer located at a point where s/he can clearly see the speaker or the visual materials used by the speaker. During this act, the incoming message enters discourse in the target language. Dependent on so many parameters, the interpreter requires advanced cognitive skills to store and manipulate the information coming spontaneously from the source for short periods of time, which renders high-order cognitive processes redundant including controlled attention and reasoning. The term "simultaneous" in this sense clearly refers to "*sensu lato*", because there exist "a certain delay of some seconds between the original message in the source language and its translation into the target language on the part of interpreter" (Fabbro 1999:202). This delay is generally related to the duration of a sentence or the time required to identify a meaningful chunk to start interpreting. After a tough selection process and through a considerable graduate-level training, interpreters are trained to develop strategies to avoid word-for-word interpreting as might be understood from the previously mentioned term "*sensu lato*" and to acquire coping strategies to overcome the extensive cognitive load during this process.

Although they are two closely-related linguistic disciplines, interpreting essentially differs from written translation in that it is not limited to the variables of a given text and the main variable to this extent lays on the medium. In addition to many morphological, syntactical, lexical and conceptual difficulties, and many others

stemming from the structure, function and form of a given text that a translator has to cope with in linguistic context, there also exist many extra-linguistic features an interpreter has to deal with. While a translator has the time enough to access any supplemental reference materials to produce an accurate verbal artefact, the interpreter will receive a complex message from one language, end up the lexical decision process in the target language in a very short time to faithfully render the message in a tonally - which at the same time should be adjusted professionally in order not to sound chant and monotonous- linguistically, culturally, and emotionally equivalent message. At this point, the difference between skills required from the practitioners of both disciplines should be separately classified. The most prominent characteristic of a good translator is the well addressing skills in the target language in addition to the parameters of linguistic and cultural skills. However, it is known that even bilingual individuals can rarely express themselves in a given subject equally well in both languages, and many translators are not fully bilingual. That is why EU insists on claiming from a translator/interpreter to only translate documents into his/her native language. However, an interpreter in general must be able to translate in both directions instantly, without getting any support from any resources like dictionaries or glossaries. They must also have advanced public address skills and the intellectual capacity to convey idioms, colloquialisms and other culturally-specific references into analogous statements in the target language on spot, which is already a demanding task in usual conditions.

In addition to these variables an interpreter is always dependent upon, there is also a “stress” factor. Research has shown that after 30 minutes of sustained interpreting, the accuracy and completeness of simultaneous interpreters seems to decrease sharply because of the fatigue as human mind cannot hold the needed level of focused concentration much longer than this duration. In a study on stress and fatigue during conference interpreting by Moser and her colleagues (Moser-Mercer et al., 1996) concluded that the interpreters may not be even aware of the increasing number of errors in their performances because of the cognitive overload. As to the complexity of the task, Tommola and Hyönä (1990) referred to it as:

Simultaneous interpreting is a highly complex discourse performance [...] where language perception, comprehension, translation and production operations are

carried out virtually in parallel and under severe time pressure. [...] the task [...] is likely to create a heavy processing load. (Tommola and Hyönä 1990: 180)

while Kurz added “When he interprets, the interpreter is under pressure.” (Kurz 2002: 197)

Thus, it is definitely a very challenging act and even in case of professional interpreters on the job. Alternating throughout the task for an average of 25-30 minute intervals is often preferred in order to avoid ambiguity and loss of output quality as much as possible stemming from cognitive overload. The intensity of this mental overload is also confirmed by researchers in cognitive science and linguistics today. They agree on the hypothesis that simultaneous interpreting task leads to extensive anterior and posterior, predominantly in left-hemispheric structures in both hemispheres, while the processor needs to store and reformulate at the same time, which is different from the usual communication pattern. Another study by Kurz on the physiological stress during simultaneous interpreting (2003: 53-56) emphasizes empirical stress research over the last twenty years and points out the environmental (humidity and air quality in the booth), psychological (individual's self-confidence or the way he/she judges a situation) and physiological (mental load due to listening and shadowing) stress under which interpreters work. Vidal (1997) points out: “Fatigue for interpreters is not primarily physical, [...]. It results from complex mental processing and the high degree of concentration the interpreter must have to hear, then understand, analyse and finally express ideas coherently in another language.” She also quotes Patricia Michelson (A Handbook for Ohio Judges: 106) who reported in *The Court Management and Administration Report*: “Most people do not realize that an interpreter uses at least 22 cognitive skills when interpreting,” and goes on to state, “[...] other studies of simultaneous interpretation have shown that fatigue is exacerbated by environmental factors that interfere with various aspects of the cognitive process.”

All the mental processes mentioned hereby require multi-tasking strategies for an interpreter to cope with during interpretation and according to the studies to date, are a product of long and short term memory and principally fluid intelligence (Gf), which is the ability to reason logically, identify relationships and solve problems in relation to novel stimuli (Preece, 2011) independent of the knowledge and skills acquired during a

lifetime. Therefore, it is pleasing to say that possessing commonalities with many other fields other than linguistics like sociology, psychology and neurology, the irrevocable multidisciplinary of simultaneous interpretation has recently begun to lead incrementally more researchers to provide insight into this physically and cognitively demanding task. Although simultaneous interpreting is a fairly young discipline in terms of scientific studies, cognitive information processing has been a point of interest for the scholars in this field. The act of interpreting has especially become significant for psychologists and psycholinguistics for theoretical memory models and mental lexicon studies because it feeds questions like “how do we process and comprehend language, how we produce language and how we acquire a new language which superiorly underpin psycholinguistics (Murray, 2001). Phonetics, morphology, semantics, pragmatics and morphology also contribute to psycholinguistics as the irremissible aspects of interpreting.

However, simultaneous interpreting oversteps the boundaries of psychology and turns out to be a focus point also in neurology and cognitive science in that it is a profession which requires efficient use of the multi-tasking strategies, managing divided attention, and an appropriate ear-voice span or time lag, immediate priming and response in addition to knowledge-based studies, proficient use of which are likely to make structural changes in the brain plasticity as a result of extensive hemispheric activation. These post facto skills become unavoidably necessary to acquire during the training process to improve professional competence. Yet, they are certainly difficult to acquire due to the mentally challenging nature of the task and the fact that one depends not only on the physical and cognitive capacities but also on environmental factors and stress points. Simultaneous interpreting contributes to neurolinguistics and vice versa by providing answers to questions like “how the brain separates speech sounds from background noise, how the phonological system of a language is represented in the brain, how the brain stores and accesses words and how the brain use words to form multiple-word utterances and sentences”. It goes without saying that bilingual or polyglot interpreters have become popular test subjects lately in neurolinguistics as these people are a great source for the observation of the relationship between brain structures and language acquisition, stages of language and brain development and the

neuroplasticity following a second language acquisition and expertise in simultaneous interpreting.

It must be beyond doubt that one of the most restrictive characteristics of simultaneous interpretation requiring utmost effort is probably the “simultaneity” of the task which means that one has to transform a message from one language to the other – from source language to target language or vice versa- exactly at that point where the comprehension, transformation and production through listening and speaking occur. Thanks to the invaluable studies of researchers up to date, we know how this process between hearing and understanding actualizes in our brains. In short, sound information from outer ear reaches inner ear, where it travels to the brainstem. Then it is transferred to the thalamus and then relayed to the temporal lobe which deals with verbal memory and plays an essential role for SI process. Wernicke's area is also located in this lobe and is important for language understanding and interpreting sounds by effortful decoding and encoding. After word analysis and understanding the input, it comes to articulate an output in another language and thus “switching” in case of an interpreting task going on (Wright). Broca's area in the frontal lobe deals with organization, production and the manipulation of speech and language and the Parietal Lobe enables spoken and written language to establish a link to memory so that a meaning can be ascribed. (Wise, 2003). It sounds like a very difficult yet perfect mechanism when described in detail, but the hard core of the interpreting task is located just here, at the memory, without which the SI task itself would not be possible for human being to achieve. It is also memory and the spectacular impacts of its potential capacity on the act of simultaneous interpreting that we are going to look through with this study.

1.3. WORKING MEMORY- THE RAM (Rapid Access Memory)

Working memory (WM) is the system which helps us carry out our daily activities like holding an address in mind until we reach it, make a mental arithmetic, hold a telephone number in mind for a short period of time or play chess by enabling us to foresee possible future moves and their possible consequences. Actually, we have a natural ability to remember many facts and events about the environment around us, yet only a

few can be successfully accessed when needed at a given time. That is the reason of why things get more difficult for us when the actions mentioned above include more words, digits or moves respectively. There, working memory in other words may be defined as “a system for the temporary storage and manipulation of information amidst distraction or concurrent processing, which is essential for complex cognition, especially for simultaneous interpretation, and can be understood as a mental workspace with a limited capacity” (Conway & Getz, 2010: 362-364) correlating to a great extent with general intelligence (IQ) and reasoning.

There exists also a computer metaphor in cognitive psychology for the nature and structure of WM similar to the context of theories that associated the brain to a computer after the term working memory has been propounded by Miller, Galanter and Pribram (Pribram et al: 65). Like a computer storing information by hard disk and random-access memory (RAM) where hard disk is used to store software programs, files and operating systems permanently and reliably and RAM to reinstate this stored information, our brain uses long term memory and short term memory in the same way to store permanent and temporary information in our minds respectively. When we hear or read a word, it is located in our working memory. Then it is associated with a memory of that word’s meaning and thus we understand. When a task is completed, WM is reset and ready for the next one like the RAM in a computer. So, it depends on the content and therefore it is flexible. So, it goes without saying that like a computer, the greater the RAM is, the more complex programs with updated qualifications one can run on it and more speed you get your computer perform these programs at the same moment. According to the working memory theory, we think, focus and solve problems in our WM. Therefore, learning disabilities like ADHD are thought to be caused by an error in WM. Yet, this leads us to the very reasonable conclusion that human kind would be able to possess greater academic achievement, better ability to focus by resisting distractions or contributing to complex discussions by improving his/her working memory skills. Over and above, this means that not only healthy people but also learning-disabled children may also benefit enhancing their working memory limits and have better attentional stamina and more mature behaviour.

The term was first proposed by Baddeley and Hitch (1974: 47-89) in 1970s as a modification of the concept of short term memory to differentiate between short term memory, which is a simple storage of information and working memory as a cognitive component bringing storage, processing and executive control of the on-going process together (Timarova, 2007). Working memory has turned out to be a leading area of research as more and more empirical studies founded concrete links between working memory capacity and higher cognitive processes. A number of studies, for example, illustrated a difference between working memory of simultaneous interpreters, SI students and non-interpreters (SI; Daro, 1989; Bajo, Padilla and Padilla 1995) and also a greater semantic processing capacity in simultaneous interpreters when compared to teachers although proficiency in a foreign language may enhance fluency and WM skills (Stavrakaki, Megari, Kosmidis, Apostolidou and Takou 2012). Working memory is now also known to be related with reading comprehension (Daneman and Caprener, 1980), language comprehension (Just and Carpenter, 1992), taking lecture notes (Kiewra and Benton, 1988) reasoning (Kyllonen and Christal, 1990), vocabulary learning (Baddeley, Gathercole and Papagno, 1998), problem solving (Kyllonen and Christal, 1990). It has also marked a new epoch that the basis underlying the behavioural symptoms observed may be WM problems and children with attention-deficit hyperactivity disorder (ADHD) thus may fight distractibility and poor reading skills by WM training.

Working memory training models have been continuously developed and come incrementally into more prominence especially after it has been postulated that training on working memory results in the improvement of fluid intelligence (IQ) under the leadership of Susanne M. Jaeggi and her colleagues. According to this study, subjects succeeded in increasing their intelligence by exercising a WM training called “the dual n-back task”, and the results provided concrete positive results towards the plasticity of the brain. It has also been widely accepted and approved by a recent meta-analysis that dual n-back task clearly responds to the aim of increasing Gf (S.M. Jaeggi et al, 2014) by enforcing the visual and verbal short term stores of working memory. In this study, this specific WM training exercise will be further investigated in terms of its impacts on the simultaneous interpreting performances of students.

1.4. DUAL N-BACK TASK IN PRACTICE

The limitedness of the working memory restricts the extent of information which can be maintained within the system (Baddeley, 2003) and scientists have been searching ways to enlarge these limits of working memory in order to keep and process more information which in turn will pave the way to higher IQ levels and thus greater academic success. The interest in WM training has shown a dramatic boost in the past decade as more and more studies successfully demonstrated that the long-standing assumption towards the claim that the WM capacity is an inherent trait and insensitive to environmental influence might come down. Recent research indicates that WM capacity can be improved with gradual training by elaborating the Gf and some concomitant advantages accompanying this training such as the potential to treat neurological and psychiatric disorders have also supported the idea that training our brains is in fact possible.

Among all the training exercises developed in the name of enlarging the WM capacity and boosting the intelligence quotient stand especially one very promise-holding and widely studied brain training task called the “dual n-back task”, the most well-known of which has been developed by Dr. Susanne Jaeggi and her colleagues in 2008. It has been shown by recent meta analyses that dual n-back task clearly responds to the aim of increasing Gf (S.M. Jaeggi et al., 2014) by enforcing the visual and verbal short term stores of working memory. In this memory training task, the subject is presented with a series of stimuli at a regular rate where “n” refers to the stimuli and asked to decide if the presented stimuli match the stimuli n positions back. The word "dual" refers to the fact that one needs to recall a sequence of auditory and a visuo-spatial stimuli separately which distinguishes it from the original “n-back” task where a single kind of stimulus is presented at one time. The paper by Susanne M. Jaeggi, Martin Buschkuhl, John Jonides, and Walter J. Perrig, "Improving fluid intelligence with training on working memory" exhibited how the attendants increased their intelligence measured by Gf by playing the dual n-back game. In the study, people took an intelligence (Gf) test and then practiced the dual n-back game for 8 to 19 days. They took another intelligence test at the end and their scores were relatively better than those who didn't play the n-back game or the control group. The study was moliminous not only because of the increase

in attendants' intelligence (Gf) levels but also because the people who played the game longer did even better on the Gf tests. This indicates that the benefits gained were greater when the training period was longer.

This exercise seems to improve the working memory by forcing someone to remember a sequence of n-back items that increases in length as the game gets harder in working memory or in other words in the bottleneck of learning. The better scores one gains during the game, the further back in the sequence s/he must remember. Shortly, each session takes about a minute, and one needs to practice the task min. 20 minutes for at least 5 days of the week to get concrete results in terms of WM capacity and IQ improvement.

There have been gradually more studies on WM training in terms of the improvements in plasticity but obscurity subsists concerning the evidence on transfer of its effects into more general cognitive domains such as fluid intelligence (Gf) as well as how long the benefits gained will be maintained. Among these papers, the "meta-analysis on improving fluid intelligence with training on WM" published by Jaeggi, Au, Sheehan, Tsai, Duncan, and Buschkuhl in 2014 brought some clarification to the subject and in the light of some laboratory tests, they concluded that short-term cognitive training can result in other benefits regarding significant cognitive functions. This study will contribute to the previous data gathered up-to-date on the dual n-back task in terms of its cognitive beneficial effects on simultaneous interpreting as a highly demanding cognitive action.

1.5. SCOPE OF THE STUDY

Many studies have shown that the dual n-back training may cause structural changes in brain plasticity by improving the ability of shielding interfering information, and enhancing verbal learning, auditory processing speed and components of attention (Diamond, 2013), which are all significant cognitive processes of WM carried out during interpreting. Furthermore, recent studies set light to the fact that much of the variance in fluid intelligence and working memory span is shared and this suggests that

they have some neural mechanisms in common (Burgess et al. 2011). In the light of these promise holding results, we investigated if the dual n-back task would help the participants extend their memory spans and if the WM training would cause any improvement on the students' recalling capacity of lexical items, figures and sequential events.

This study aims to correlate two closely related disciplines with each other - simultaneous interpreting and cognitive science- through a new cognitive training method – the dual n-back task where the hypothetical models of working memory such as the WM model of Baddeley and simultaneous interpreting models of Gerver (1975: 119-128) Moser-Mercer (Moser-Mercer, 1978: 353-368), Darò and Fabbro (1994: 365-381) and Gile (1995) constitute the basis. The task was applied to a group of 3rd-year Simultaneous Interpreting students to see the possible impacts of the WM training on the interpreting performances of the students concerning their competence to deal with the challenging nature of the act. Depending on the analyses carried out, it might be concluded that this WM training exercise may be utilized as an applied training method for simultaneous interpretation students.

A detailed description of the studies conducted up-to-date on simultaneous interpretation, cognitive science and neuroscience will be depicted in the next chapter with a detailed explanation of the dual n-back task which is used as a working memory training task in this study.

CHAPTER 2

STATE OF ART

This chapter will emphasize the substantial impact of different disciplines on the development and transformation of the interpreting studies and how this interdisciplinary movement reshaped the theoretical and practical perspectives on the domain of interpreting studies. The most widely studied process models of Simultaneous Interpretation, which constitute the basis of the study equally together with the working memory models will be described and how the research in these two disciplines meet on a common ground in cognitive science will be addressed.

2.1. INTERDISCIPLINARITY

In early 1990s, creditable approaches to written translation began to be investigated in the field of interpreting relatively intensively. “Shared Ground in Translation Studies”, a position paper published by Chesterman and Arrojo (2000) in *Target* drew much attention from other scholars working effectively in interpreting studies. Since then, essential theories and insights based on translation studies shifted and begun to have a directive impact on interpreting studies in terms of creating the diversity of theoretical foundations in this area. However, most research on interpreting up to date was not shaped only by scholars investigating the closest disciplines “translation studies” and “linguistics”, but also by many interdisciplinary approaches nominately from cognitive science, neuroscience and psychology in the first place.

The main reason of such a significant interest of various disciplines such as cognitive science, neuroscience, neurolinguistics and psycholinguistics in simultaneous interpretation was cognitive performance of “the interpreters” as “language experts”. Obviously, interpreters turned out to be paramount data resources for the researchers from these fields when investigating language disorders as more and more interpreters have become more of an issue all around the world. Moreover, this connection has started to be bi-directional in late 1990s, when, this time, practising researcher interpreters i.e. “practisearchers” decided to benefit from these disciplines for further

investigation of their own expertise. The first experimental study of simultaneous interpretation was conducted by a psychologist, Pierre Oleron, and published in Washington in 1963 at the 17th International Congress of Psychology, at a time when simultaneous interpretation gained the attraction of researchers in psychology. The study focused on the time delay (*decalage*) between the input coming from the speaker and the output produced by the interpreter and concluded that the act of interpreting was a highly complex process “*whose variations must be presented by the analysis*” (Pöchhacker & Schlesinger, 2002:43). The first PhD research on simultaneous interpretation was conducted by Frieda Goldman-Eisler, a researcher in psycholinguistics, in 1967 which took the length of pauses and anticipation into focus as an indication of the complexity of language production. On Broadbent’s (1952) suggestion that even after many years of professional working, interpreters try to benefit from brief silences in SL due to the severe strain on human channel capacity, Goldman-Eisler (1968) concluded that “the more of his own output he can crowd into his source’s pause, the more time he has to listen without interference from his own output”. After another PhD thesis in 1969 at the University of Vienna by Ingrid Kurz on divided attention, the leading representative of psychological interpreting research, David Gerver from Oxford University, reported the results of his experiments on the effects of some variables such as the high speed rate, unusual intonation and noise on the output quality with his doctorate research on “Simultaneous Interpretation and Human Information Processing” in 1971. Following Gerver, Barik (1973) investigated Goldman-Eisler’s suggestion on the interpreters’ making use of brief silences between chunks of speech in the speaker’s utterance and concluded that the interpreter’s delivery was independent from the intervals and pauses in the SL.

The factors underlying the performance of interpreters kept to be an area of research and besides, the level of proficiency was put under the scope for further investigation. In another study by Barik (1975), professional conference interpreters, amateur interpreters who commanded a foreign language but did not have any interpretation experience) and student interpreters were compared and their performance were analysed in terms of the omission, errors and additions made. Barik reported that the less proficient interpreters were better in interpreting from their native language into their non-native language

since they made fewer errors, they could make the translation of the sense rather than words and they were also found more adequate.

The first interdisciplinary symposium on interpreting took place in 1977 and was co-organised by Gerver in Venice. This was a hallmark in the history because many experts from different disciplines like cognitive psychology, sociology, artificial intelligence and linguistics founded a middle ground on the purpose of elaborating the basis of interpreting research. These strides made towards more scientific approaches on interpreting were followed by Catherine Stenzl, Jeniffer Mackintosh, Daniel Gile, Barbara Moser-Mercer and Sylvie Lambert in 1980s and they strengthened the perception of interpreting as a cognitive information processing, the foundations of which were already laid in 1970s. A building block in this sense was the Marianne Lederer then emphasized that interpreting was above all a cognitive activity as a human performance and concentrated on the process of the act as a factor of communication in her paper “Simultaneous Interpretation: Units of Meaning and Other Features”, first published in 1978.

Another step stone in the transformation of interpreting into an interdisciplinary discipline was the international symposium on conference interpreter training in 1986 by the University of Trieste and this event established the foundations of SI in the domain of neurolinguistics. Representatives of Trieste School together with Gile organized the “International Conference on Interpreting” in 1994 in Finland and this event once again underlined the interdisciplinarity of the discipline in addition to neurolinguistic paradigms, cognitive aspects, quality assessment, training and developing skills. Later in 1996, “*Interpreting: International Journal of Research and Practice in Interpreting*”, an interdisciplinary journal launched by Barbara Moser-Mercer would be a key for the future approaches in this field with its loud and clear cognitive-science orientation in terms of canalising the borders of the discipline’s horizon.

In accordance with these developments that have carried the interpreting research up to a point where many scientific disciplines converge on, interpreting researches prioritised the notion of “process” in contradistinction to written translation theorists, who mainly dwelled upon linguistic units used during the transfer. Thus, interest of

scholars in the field of psychology in “verbal behaviour” at the level of conditioned reflexes shifted to an emphasis on cognitive processes inside the “black box” or mental processes taking place within the brains of interpreters on work. As already mentioned, interpreting is a profession requiring higher cognitive demands and research on simultaneous interpreting has been underlining some preferential cognitive issues over the past five years, most particularly those conducted by Barbara Moser-Mercer from Université de Genève. These issues include primarily the role of working memory, substantiality of cognitive processes, managing cognitive overload, simultaneity of language processes, relations and differences between bilingualism and SI, constraints and limits of mental processes, “on-line switching” and the role of long-term working memory on the way to be a professional interpreter. The fact that simultaneous interpreters can speak fluently at least two languages and are trained to control their language system in order to comprehend and produce speech concurrently in two different languages while at the same time performing on-line switching somewhere in-between these production and comprehension processes has recently generated an emerging interest on the way that interpreters make use of their working memory.

Furthermore, with the contributions of information theory and cognitive psychology, the processes taking place in the “black box” of an interpreter have turned out to be associated and exemplified with a set of information processing operations like those existing in computers. Gerver defined the interpreting task within this framework as “*a fairly complex form of human information processing involving the reception, storage, transformation and transmission of verbal information*” (Pöchhacker, 55). According to these operations, humans were performing a series of cognitive skills to achieve the incredible act of interpreting, some of which are speech recognition, making use of working memory resources and producing verbal information. The idea of “interpreting” as a complex information processing skill paved the way to an experimental environment in the 1970s, when the interdisciplinary of cognitive science emerged as a promising new super-paradigm for the study of language processing and other cognitive functions. (Wadensjö et al: 27). Based on his findings from his PhD thesis in 1971, Gerver also developed the first information-processing model of simultaneous interpretation which will be touched upon under subsequent chapters in this study.

2.1.1. Different Dimensions of the Process

In Simultaneous interpreting (SI), the interpreter receives a message from the source language in segments, decodes, processes and then conveys it by encoding it in the target language. This continuous act is immediate and the receiver perceives this as a concurrent process, yet even if the interpreter has magnificent anticipation skills, the production of the SL segments and the interpreter's output in TL can never be generated at the same time because of the differences in the sentence structures between two languages. Simultaneous interpretation is a multi-phase and non-stop process except for the pauses made by the speaker, and the mental phases can be ranged respectively as: 1) the decoding of a SL segment which encompasses the perception and comprehension of the incoming linguistic information, 2) encoding of it by producing a coherent, syntactically and lexically equivalent in terms of discourse features, 3) presenting the encoded message in the TL with an appropriate phonetic aptitude, which should also be equivalent with regard to the context, register and function and 4) the output monitoring and self-correction if required. However, perhaps the utmost effort needed to be put forth among all of these processes is the continuous attention that should be paid to the ongoing input because one strictly hinges upon the working memory paradigms.

During this multi-phase process, the quality of the discourse is determined by how the interpreter can carry out the above mentioned processes and this depends on some specific external factors as well as the proficiency level of the interpreter. First of these factors is the correspondence degree between two languages which means that if the syntactic features of languages are similar, the interpreters will not be obliged to make risky anticipations. There will be no need to process large segments and information loss will be less compared to the situation between languages syntactically similar. Speaker's performance is also a parameter as it may have an effect on the segmentation. For example, the pauses and rate of the speech are what the interpreter takes into account when executing their memory resources. The kind of the text being worked on is also essential because if the adaptation of it into the target culture is difficult, the interpreter will apply to other communicative possibilities. Physical conditions in the booth also play an important role and the humidity or air freshness inside the booth is

one element that can affect this. Technical equipment should be functional and properly working so that any disruptions on work might be prevented.

The multi-tasking performance of simultaneous interpretation creates a cognitive overload due to the time pressure and stress. Problems most probably occur when the required cognitive capacity exceeds the individual processing capacity of the interpreter. For this reason, interpreters are trained to develop specific strategies for managing cognitive overload and accomplish the automatization of the active application of these strategies. The paper titled "*Processing Strategies in Simultaneous Interpreting: Saying it all vs. Synthesis*" by Marianna Sunnari (1995) showed that the professional interpreters successfully applied macro-processing as a strategy of high quality interpreting between English and Finnish while trainee interpreters failed to produce a coherent message in target language. In other words, this supported the idea that the full mastery of the interpreting act depended on some cognitive adaptations. On the other hand, Gile expressed these specific strategies (1999) at a conference and classified them as "preparation and coping tactics" which are divided into three subtitles as "comprehension", "prevention" and "reformulation". First one includes reconstructing the segment with the help of the context, apply to booth mate's help or documents relevant in case of no booth mates available whereas preventive strategies mean taking notes, changing the ear-voice span, segmentation, changing the order of elements in enumeration. Reformulation strategies on the other hand may include replacing a segment with a superordinate term or a more general speech segment, explaining or paraphrasing, reproducing the a sound heard for the first time, transcoding, omitting some information or parallel reformulation.

The cognitive information processing skills and strategies used during interpreting have swiftly become one of the most compelling research area up to date galvanized the quest of cognitive models for the act of simultaneous interpretation and also for working memory in addition to others already developed at anthropological, socio-professional, institutional, and interactional levels.

2.2. EARLY STAGES OF THE DEVELOPMENT

During professional interpreting, one needs to constantly work within many different parameters (Collados, 2007) like the cohesion, diction, attention to the tone of the voice, style, fluency, complete and correct transmission, ideal accent, intonation and terminology also being dependent on existing external conditions such as the air freshness and sound quality inside the booth, collaboration between booth mates and above all the booth visibility to follow-up the visual materials used by the speaker to support the content of the speech. Each of these mental processes above alone necessitates extreme feats of multi-tasking and split-attention while working between two languages in simultaneous mode. Speech recognition, memory storage and production of verbal output in this sense require a series of cognitive information-processing skills. It was Julius Wirl who first put the idea of interpreting as a language-switching operation and paved the way to the boost of experimental research on SI within the frame of bilingual verbal processing from a cognitive-psychological perspective. The act of interpreting was referred as code-switching or transcoding and psycholinguistic studies began to handle the difference between the time used for “code-switching” and “shadowing¹”. Mental processing operations carried out during interpretation kept drawing the attention of scholars and practisearchers striving for modelling the phenomenon and being the focus of empirical research after Paneth as a practitioner has become the first to write an academic study on this profession in 1957 and presented a MA Thesis on “Investigation into Conference Interpreting”. Paneth emphasizes how interpreters manage information and discusses interpreters’ use of lag time which is also referred to as “ear-voice span” (Treisman 1965; Oleron and Nanpon 1965), segmentation of the message and the use of pauses to catch up to the speaker. In 1960’s, Van Hoof (Metzger), stated in an extensive monograph that “split attention or split memory is an information-processing approach to understanding interpreters’ ability to engage in multiple tasks”.

The experimental period, including the 1960s and early 1970s for which it would be fitting to say that was initiated by Paneth, a few psychologists and psycholinguist such as Pierre Oleron and Nanpon, Treisman, Goldman-Eisler, Gerver ad Barik turned out to

¹ The act of repeating verbal information in one language simultaneously.

be relatively interested in the act of interpreting. Oleron, the founder of the genetic psychology laboratory of La Sorbonne, and Hubert Nanpon (1964) developed a method for making precise measurements of the ear-voice span (EVS) and their study was published in the *Journal de Psychologie Normale et Pathologique* in 1965 and first presented at the 17th International Congress of Psychology in 1963. In this study, they calculated the ear-voice span using recordings of a number of interpreters observed in the laboratory and at conferences to examine the accuracy (also considering additions and omissions) translating various kinds of texts in different lengths in-between various languages. They noted that “*the term simultaneous interpretation is an approximation only, covering a fairly complex process whose variations must be presented by the analysis*” and they also point out “[...] – *that when it comes to interpreter performance, the time variable is not uniform.*” They made a comparison between the interpreted and translated versions and found out that interpreted versions were longer than translated versions and added that the time-lag during interpreting depended on some variables like the speech rate and text type as these were what the interpreter has to process in order to generate an output. This investigation was one of the first experimental studies appeared until then as it made use of quantitative values. Treisman, also in 1965 found that ear-voice span was greater for interpreting than for shadowing and concluded that the difference between the performance of interpreters and shadowers were due to the “.... increased decision load between input and output required in translation ...”

Later in 1968, a workshop for the interpreters and interpreting studies took place at the Alpbach (a high-level European Forum) and there, research oriented interpreters met with a specialist in medical science to handle issues like “*.mental processes and input variables, skills testing, machine interpreting, stress and fatigue, ethics and client expectations*” (2004:33). The same year, Carey conducted a PhD study on “Delayed Auditory Feedback and the Shadowing Response” in which the fact that the errors made by the shadowers increased in parallel with the increase in the rate of input was pointed out. Later in 1971, she demonstrated that shadowing involves a less complex transformation of the message and concluded that “*....the difference in recall between shadowing and interpreting might be due simply to the different demands placed on speech output by the two tasks...*” Also in 1971, a study by Kade and Cartellieri claimed that the processes of speech being generated by the speaker and the transformation of

this speech into another language are concurrent instead of successive, and thus a shift between the speaker's speech and the output of interpreter is inevitable. They suggested that interpreters' common tendency to utilize SL pauses, interruptions, and redundant speech segments to minimize the time-lag or to manage the "start-up distance" and catch up with the speaker was due to the cognitive overload as the two processes are concurrent, while the role of the short-term memory and its capacity as an obstacle for the interpreter regarding this overload had already mentioned by Pinter (Kurz) in 1969 and subsequently by Lederer (1978) and Wilss (1978). Following Chernov's, a former UN interpreter, demonstration of a simultaneous interpretation model framework based on the suggestion that:

"... probability prediction concerns successive units of sense (semantic components and their relationship) in a SL message, while the interpreter is engaged in the anticipatory synthesis of verbal components of the TL message he is in the process of regenerating." (Pöchhacker, 2004: 106)

Kirchhoff from the University of Heidelberg also handled the interplay of the processing operations such as anticipation and compression and claimed that the language-pair specific strategies had an enormous impact on the interpreting process. Kirchhoff (Pöchhacker 2002: 118) also declared that in consecutive interpreting, data are stored fundamentally in long-term memory whereas it is stored in the short-term memory in simultaneous interpretation and that the interpreter will not be able to store information in long-term memory if "...*the complexity of the task does not leave any processing capacity available.*" unless she/he tries to memorize it by intentional learning in case of a need to understand the context completely to process the text.

On the other hand, the developer of the Interpretive Theory or Paris School, and also one of the first translation theorists interested in the cognition of translation, Danica Seleskovitch was still not convinced that linguistic theories of 1960s or psychological experiments of 1970s in the language laboratory were adequately explaining the interpretation process. She emphasized the importance of observational studies of professional practice as a conference interpreter herself. In 1975, Seleskovitch was among the first to regret the idea that the oral translation is carried out by a word-for-word transcoding. She put across a theory in her doctoral dissertation that the linguistic

units in the message received are “deverbalized” first into units of sense and subsequently converted into a message in TL after the interpreter grasps the meaning or “sense” from the SL by making use of her/his language or extra-linguistic knowledge. This study was primarily on note-taking in consecutive interpreting and would then be discussed by Marianne Lederer. According to Based upon the results of Kade’s and Cartellini’s study, a practicing interpreter, Lederer (1978) developed Seleskovitch’s work further and made a difference between the types of information processed by the interpreter. Noting that interpreting is a “*human performance in which cognitive activity is first and foremost...*” and “everything that is spoken in a booth in response to speaker’s utterances is interpreting and representative of the state of the art ...”, she explained that the incoming information can be linguistic or extra-linguistic. In case of extra-linguistic anticipations the interpreter makes use of her/his general knowledge. She clarifies that at the beginning of any meeting when there is little known to the interpreter regarding the scope and direction of the speech, they can only apply to lag as little as possible from the speaker’s words to pursue the activity. As the speech goes on and interpreter analyses any information received, she/he can get the grasp of the real meaning of what the speaker is saying. Thus is the stored knowledge built up and the interpreter wander away from the rendering of the linguistic meaning of the source text, she/he turns out to convey the message in the target language in a much natural way and also sound more native. With regard to the time lag, she suggested that this pause is necessary to get the amount of information needed for understanding of the speaker’s meaning. She identified “*the units of meaning*” as the “*segments of sense appearing at irregular intervals in the mind of those who listen to speech with a deliberate desire to understand it.*” According to this concept, chunks of sense appear during interpretation as soon as the interpreter clearly figures out the intended meaning of the speech. Units of meaning in this sense are “*...the synthesis of number of words present in short-term memory associating with previous cognitive experiences or recollections...*” and this is where simultaneous interpreting and cognitive science combines to make a whole.

2.3. SIMULTANEOUS INTERPRETATION INTERSECTING COGNITIVE SCIENCE

The psychologically oriented studies which focused on the qualitative dimensions of interpreting, such as “The Effects of Source Language Presentation Rate on the Performance of Simultaneous Conference Interpreters” (1969) and 1971 doctoral dissertation of David Gerver previously mentioned in this study led researchers to turn their direction into more quantitative variables affecting interpreters’ performance. Generally, this experimental study investigated factors affecting interpreters’ short-term memory capacity like the impact of noise, list length, message structure and input speed and based on his findings, he developed the first information-processing model of simultaneous interpreting. Additionally, he clearly demonstrated that beneficial results were to be gained from controlled experimenting for the sake of simultaneous interpretation. In spite of such a favourable environment in 1970s, the study of interpreting kept being investigated mostly by professional conference interpreters on work under the leadership of Seleskovitch.

During 1960s and 1970s, psychologists and psycholinguists kept on conducting experimental studies on the psychological and psycholinguistic aspects of SI and focused on some variables (speech rate, time-lag, pauses in speech delivery, noise, etc.) having an impact on professional interpreters. However, at the beginning of 1980’s, a group of conference interpreters, including Daniel Gile, Jennifer Mackintosh, Barbara Moser-Mercer and Catherine Stenzl pointed out the need to draw on scientifically oriented approaches to research as they refused the validity of methods and the results of these studies by advocating that subjects, tasks and the experimental environment had not much in common with the very act of interpreting. The 1986 Symposium at the University of Trieste (Dodds 1989), which could be referred to as a mile stone in the history of this professional discipline, emphasized the significance of the empirical and experimental research in cooperation with other disciplines. The “IT” paradigm by Seleskovitch left its place to the cognitive processing, ‘CP paradigm’ led by Gerver and the focus shifted to the interdisciplinary approaches from many domains of psychology. Cognitive neuropsychology emerged as a signifier of the rise of a neurolinguistic

paradigm (NL) of interpreting research contributing to the field by helping the researchers study the linguistic functions of the brain on-line.

Gerver's findings had an impact on the later works on interpreters' performance on post-task recall tests such as that of Lambert in 1983 which compared the effect of silent listening, listening while shadowing, simultaneous and consecutive interpretation and concluded that listening to a language and at the same time dealing with many processes to convey it in another language required a higher level of analysis than carrying out these two tasks in the same language. In another study, Lambert (1989) has shown that people were better at free recall of verbal stimuli after consecutive interpretation in contradiction to SI. He suggested that SI required a less intensive processing of Long-term memory storage which had previously been put forward by Craik and Lockhart (1972) who developed the levels of processing model of memory proposing that there was no distinct difference between STM and LTM. Following Gerver's doctoral dissertation referring to the short-term memory capacity of the interpreter, many other resources have also been discussed in detail under the concept of "working memory" which was also known as the cognitive capacity (Gile 1997).

As an example of empirical evidence, Daro and Fabbro (1994) presented with their study "*Verbal Memory during Simultaneous Interpretation: Effects of Phonological Interference,*" that long-term memory supported the neurofunctional systems responsible for processes being carried out during translation. They expressed that the cause of reduced recall after SI compared to that in shadowing or listening was due the fact that during SI, subvocal rehearsal mechanisms within the phonological loop of working memory was negatively affected because of an affect also referred to as the articulatory suppression. Darò (1990) had previously conducted another study on speaking speed and its neuropsychological aspects and later in 1995 another parallel study on "*Attentional, Auditory and Memory Indexes as Prerequisites for Simultaneous Interpreting*" (Darò & Fabbro) and thus took up the self-monitoring aspect by applying auditory feedback paradigm to the phonological interference.

In fact, both the study by Darò and Fabbro (1994) and Padilla, Bajo, Canas and Padilla (1994) demonstrated that interpreters digit spans are above average supporting the idea

that working memory is involved in simultaneous interpretation to a great extent and that their performance deteriorates significantly if they were asked to pay more attention to the input or output, which suggested that the “bypassing” interference mechanisms due to divided attention requirements is strengthened by practicing (Lambert et al. 1995). These steps paved the way to the question of whether the cognitive effort needed for this task decreases with the training received for interpreting and this would be the field of investigation by Stolz (1994) and Tommola and Hyöna (1996) where the cognitive load during simultaneous interpreting was measured with the technique of pupil dilation. Interpreting students listened to, shadowed and interpreted a text and results revealed that pupil diameter enlarged more during shadowing than in listening but interpreting above all caused the largest average of pupil diameter which suggested that interpreting requires the highest cognitive load. This finding was in line with the results reported by Treisman (1965) and Carey (1971) and the study by A.Green, Sweda-Nicholson, Vaid, White and Steiner (Green et al. 1990, 1994) in which the interference on finger-tapping was found to be larger for interpreting than for shadowing, suggesting that the interpreting demanded more cognitive functioning. Another physiological study was conducted by Klonowicz (1990) who found that during shadowing and interpreting, an increased heart rate was exhibited when compared with that seen during listening.

Mid 1900s was the corner where neurological standpoint has overridden psychological approaches and this stemmed from Crevatin’s emphasis the “measurability” instead of personal experience regarding simultaneous interpretation as a “true science” at the Trieste Symposium and this step was followed by neurophysiologist Franco Fabbro and Laura Gran. At this time, cognitive neuropsychology seemed to establish a framework for studying the lateralization of linguistic functions in the brain and thus a neurolinguistic paradigm (NP) of interpreting research has emerged. Around 1988, Gran began to work on the language representation in the brain by studying aphasia and dyslexia, and mental functions and their interaction in the interpreting process. Depending on the fact that the left cerebral hemisphere is specialized for language in right handed bilinguals, Gran, together with Fabbro conducted experimental studies by making use of dichotic listening, finger-tipping and dual tasks and demonstrated the cerebral hemispheres activated or inactivated during these tasks (Gran & Fabbro 1988,

1991, Fabbro et al. 1990, 1991). The aim was to see if people with more than a language like interpreters would set out a characteristic pattern of cerebral lateralization.

An example of Fabbro's experimental designs is the one in which (Fabbro et al., 1990) the language processing was compared in right-handed interpreting students and monolingual medical students. There was no significant cerebral lateralization observed for L1 and in the interpreting students or in the control group in an automatic speech production task. When they used the "verbal-manual interference paradigm", however, simultaneous interpreters demonstrated a relatively higher degree of verbal-manual interference in L3 than for L1 and L2, which was accepted as an indicator of the involvement of less lateralized linguistic processes for languages acquired later in life.

Later in 1991, Fabbro and Gran conducted a similar investigation, where students of interpreting and professionals were compared in a dichotic listening task (participants received the source sentence in one ear and the translation to the other ear instantly) to see their hemispheric specializations for semantic and syntactic components. The study involved text comprehension in right-handed interpretation students and professional interpreters to see how well they could detect errors in sentence translation. The two group did not differ from each other in recognizing correct translations but it was interesting to observe that students clearly tended to recognize more syntactic errors while professionals detected more semantic errors. Additionally, in interpreting students, no significant asymmetries were revealed in the recognition of semantic and syntactic errors regarding the hemispheric specialization while interpreters showed "a right-ear superiority in recognizing semantic errors in L1 and a significant left-ear superiority in recognizing semantic errors in L2. In the recognition of syntactic errors, interpreters showed significant left-ear superiority for L1 and significant right-ear superiority for L2" (Proverbio, 2011). The results suggested that the level of processing the input differed for two groups and this was attributed to the perpetual practicing of simultaneous interpreting strategies of professional interpreters which could probably be the reason of the special hemispheric specializations for languages. Studies by Gran and Fabbro in general unfolded that the whole brain was included in the process of interpreting and it was deduced that: "...apparently, there was a shift of language

competence from one to the other cerebral hemisphere during language acquisition and training in interpreting...” (Gale, 2001: 89)

In another study comparing the performance of expert and novice interpreters, Fabbro and Gran (1994) picked up the trails of a more bilateral cerebral involvement during the verbal processing carried out in simultaneous interpretation. Professional interpreters were much more successful in processing semantically by making use of contextual information instead of a syntactic processing. They also showed that they could manipulate information in their working memories better, experienced less stress (Kurz 2003) and demonstrated a more right-hemispheric cerebral lateralization (Gran 1990). Fabbro and Gran’s hypothesis that bilinguals in general and interpreters in particular showed a peculiar pattern of asymmetric distribution of linguistic functions in the brain prompted other neurophysiologists to further develop the idea. Apart from this, a series of studies by Daro and Fabbro (Daro & Fabbro, 1994; Fabbro & Gran, 1997; Fabbro, Gran, Basso, & Bava, 1990) showed that subjects undergoing an intense training for simultaneous interpretation techniques seemed to have illustrated a structural reorganization in their brains. To name it, right-handed interpreters stopped exhibiting the usual superiority of the right-ear in recognizing verbal stimuli after a two-year training. Authors concluded that interpreters used their left ear to listen to the SL message while they used their right ear to control their output in TL.

Dillinger (1994) also compared professional interpreters and bilinguals (balanced) without any professional experience mainly to investigate the “comprehension.” By manipulating the syntactic and conceptual complexity of the ST, Dillinger found that professional interpreters were more accurate and their output was better in quantity but interestingly, they performed the same with bilinguals in terms of quality regarding errors and strategies used. On the other hand, during her research into SI processing activities with EEG, Kurz confirms right hemisphere involvement during language tasks in bilinguals “(Green et al 1994, 1990) and states that interpreting into a foreign language creates “greater coherence increases in the temporal region of the non-dominant hemisphere” (Kaplan: 492). With the help of EEG recordings, she mapped the patterns of cerebral activation and examined the possibility of decreasing the level of stress experienced during simultaneous interpretation by applying a hypnotic technique.

Jorma Tammola (1999), on the other hand, together with other neuroscientists, used PET (positron emission tomography) to observe the brain during translation by presenting a neural perspective against the CP (cognitive-approach paradigm) stating that interpreting studies might be subject to advanced neuro-imaging techniques.

Stemming from Gerver's study(1969) demonstrating that interpreters' success to monitor and correct themselves may decline in due course, a relatively novice researcher in the field at that time, Barbara Moser Mercer took up the self-monitoring issue in 2000 in her study "The Rocky Road to Expertise in Interpreting: Eliciting Knowledge from Learners". Her primary intention to investigate the expert-novice paradigm was to identify sub-skills or sub-processes of language processing to see in what way professionals differ from students (Moser-Mercer, 2000). She suggested that monitoring one's output is a sub-skill acquired by learners by time and it can be ignored by the interpreter in case of any unexpected challenge such as an increase in the input rate or fatigue in the semantic input. Based upon the suggestion that better monitoring strategies not only improves the quality of the output but also changes the structural organization of the brain, Hill and Schneider (Shreve et al: 277-278) described six main items about learning and brain. In summary, they stated that 1) different portions of the brain exhibit differential changes during learning, 2) shifts in the location may indicate a structural reorganization of a region due to the strategies used by the learner, 3) both an increase and decrease may be seen in the areas activated due to learning, 4) experts have a peculiar way of task execution for processing information and 5) learning can cause the structural reorganization of the brain such as some changes in the amount of grey matter or white matter.

2.3.1. Recent Explorations on Interpreting Studies

Recent explorations in the light of many experimental researches tend to look from an evolutionary approach and evaluate the human ability to speak and translate languages as a well-synchronized executive function. Not surprisingly, language includes more than one specified location of the brain like many other complex mental tasks as language covers a fast and precise coordination between multiple brain folds. However,

this network has recently been explained as an evolutionary interaction of basic regions in the cortex. Examples to this exploration are functional magnetic resonance imaging (fMRI) studies showing that language production isn't down to any one single language area in the brain but to a bunch of generalist areas pitching in, particularly a part of the brain called the caudate nucleus, which controls coordination between two lobes (Khateb et al 2007, Wang et al. 2009, Quaresime et al. 2002, Dosenbach et al. 2008). Caudate nucleus is a coordination centre known to be supporting exquisitely synchronized abilities like learning, language, memory, decision-making, and planning.

Rinne (2000) also compared SI and shadowing by using PET (positron emission tomography) and contributed to the subject substantially by reporting that "...SI activates predominantly left-hemispheric structures previously related to the lexical research, semantic processing and verbal working memory..." and "...brain activation patterns were modulated by direction of translation, with more extensive activation during translation into the non-native language..." In line with the results, Rinne (2000) propounded that interpreters conducted cognitive processes more intensively in interpreting than repetition (shadowing).

Doğan (2003) compared students' simultaneous interpreting performance before and after shadowing practice both in English and Turkish. She reported positive results and concluded that students seemed to acquire better skills to simultaneously listen and speak, activate information and maintain controlled attention in noisy environments after the practice. In another study, Doğan (2008) compared the visuo-audial digit spans of medicine, psychology and translation & interpretation students. Short term memory level seemed to have developed almost equally in the students of both medicine and translation and interpretation and a bit lower in those of psychology. At the strategy use dimension, it was found that students of medicine can have a control on their strategy use. When they were asked to use strategy, they reported that they could use it and when asked not to use any strategy, they reported that they didn't use any. However, psychology students could not use any strategy as they didn't need to during their academic studies. The finding concerning translation and interpretation students, on the other hand, was interesting in the sense that they could not help using strategy even

when they were asked not to use any. This difference was attributed to their study skills and the academic practices and performance.

In consideration of the accumulating data proposing that interpreting was a rather demanding cognitive task than shadowing and paraphrasing, Paradis (2000) proposed a neural-network account and suggested that interpretation involves at least four neurofunctionally independent systems- fundamentally one for each language commanded and one for the direction of translation (Pöchhacker, 2004: 115). On the other hand, in line with what Moser-Mercer (2000) claimed about the difference between the strategies used by the professionals and novel interpreters and the themes put forward by Hill and Schneider (2003), Golestani et al. (2008) investigated the structural and functional brain plasticity in interpreting students as they develop expertise through learning strategies and found changes in brain regions involved in cognitive control, such as anterior cingulate and dorsolateral prefrontal cortices and in subcortical regions. Dorsolateral prefrontal cortex is also referred to as where the working memory circuitry is located providing evidence that WM was intensively correlated during simultaneous interpretation. In another fMRI study by Hervais-Adelman and colleagues (Hervais-Adelman et al. 2011) authors attempted to reveal the neural substrates crucial to executive control of language by making use of language switching during production or perception, translation and interpretation. They found concrete evidence for experience-dependent structural plasticity in interpreting students subject to training as they develop expertise in the field. They reported increased grey matter volume after 15-month training period in brain regions related to semantic processing and executive function and error monitoring (See Figure 1) and the results were consistent with the results of another FMRI study conducted by Hervais & Adelman et al. (2014) and colleagues studying neural substrates of simultaneous interpretation. In this study, multilingual participants listened to sentences in L2 and then shadowed or interpreted them into their L1 (See Figure 2) and neuroimaging data of the activated regions were compared with each other.

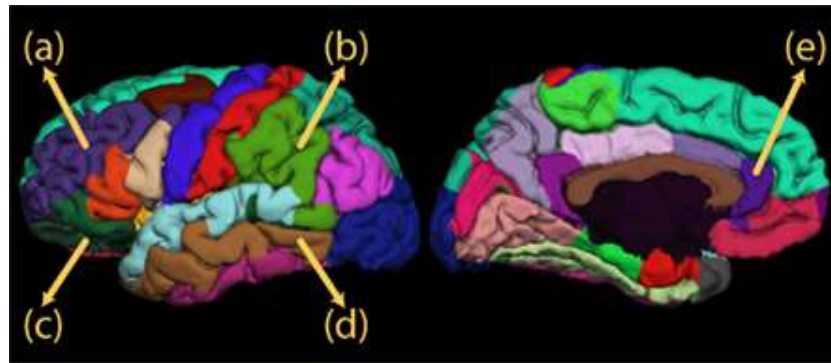

Figure 1. Regions in which authors found longitudinal evidence for brain structural plasticity in simultaneous language interpreters: (A) left middle frontal gyrus, (B) left supramarginal gyrus, (C) left pars orbitalis, (D) left middle temporal gyrus, (E) rostral anterior cingulate (Hervais-Adelman et al. 2011:4).

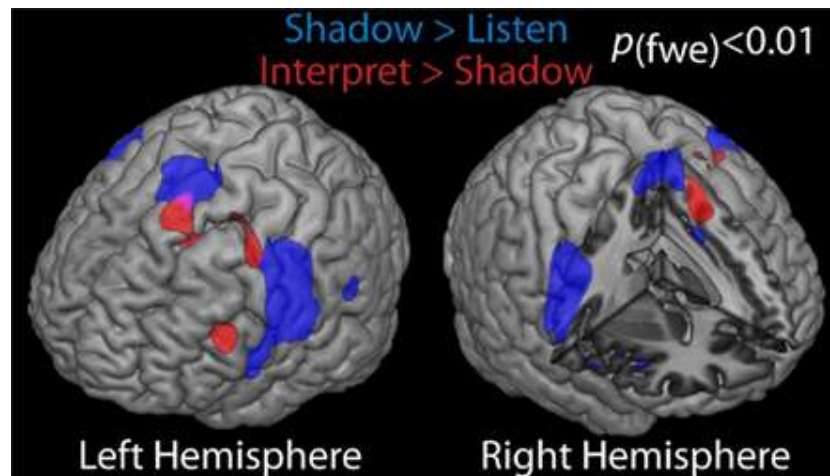

Figure 2. Significant differences in activation levels in 34 non-experts, rendered on canonical single-subject brain. Contrasts shown are speech shadowing in L2 versus listening to L2 (blue) and simultaneous interpretation into L1 versus shadowing (red) at a family wise error corrected significance level of $p < 0.01$. (HervaisAdelman et al. 2011: 4)

The results of the comparisons between the regions activated during SI and shadowing revealed that left premotor and ventrolateral prefrontal cortices and caudate nucleus were mostly engaged in simultaneous interpretation task.

Furthermore, on her review on “*The search for neuro-physiological correlates of expertise in interpreting*” Barbara Moser-Mercer (Moser 2010: 280) states that central executive function appears to be very important for interpreting and information is held in the frontal lobes of both hemispheres during the task being performed. She adds:

“When a new stimulus arrives, a temporary representation is retrieved and established in the prefrontal cortex by means of communication with posterior brain regions, in which the representations are stored permanently. According to this view, short-term working memory has the ability to simultaneously store and process information in line with Baddeley’s WM theory” (Shreeve, 2010:280).

In an fMRI study conducted by Krick et al. in 2005 (Hansen et al. 2010: 239-240), interpreters, medicine students with little contact with foreign languages and language students had to read a bilingual text in which the language changed after every third sentence. The Brodmann Area 46 (a part of the frontal cortex) exhibited a higher level of activity in professional interpreters when they switched between languages and this increased activation during switching was attributed to a change in the neurophysiology in the brains of interpreters due to their peculiar switching skills. These results were in line with Gran and Fabbro’s (1988) findings which used a dichotic listening test with EEG and propounded that the left hemisphere was dominant when language is being processed. They had concluded “that a bilateral cerebral representation of the language enhances the efficiency and possibly, the resistance to fatigue in professional interpreters” (Hansen et al: 239). Riccardi, who had revealed that the main difference between interpretation-students and professional interpreters is that the professionals benefit from appropriate strategies to deal with various situations (1998: 171-179) and they also have a greater ability to adjust to the stressful events (Riccardi, 2005), discusses later how interpreters acquire and improve their SI strategies throughout their training and professional working lives. Apparently, most of the studies conducted in this domain were supporting the rationale that the changes in the activation patterns in the interpreters’ brains might be due to training and skills acquired throughout the specialization process.

In 2008, Gile stressed that ‘imported cognitive load’ may have a strong effect on interpreting performance and suggested that pauses and sentence endings with low information density can reduce such interference. Later on, Rennert (2008) analysed the impacts of visual input during SI and Lee (2002) investigated the ear-voice span during SI between English and Korean while Al-Salman and Al-Khanji (2002) took up the “native language factor in SI”. In light of their findings, they agreed with Lederer (1978), who indicated that “understanding is not the only process of the human mind

that can be studied in interpretation...” and confirmed Lambert’s (1978) results that put forward the dominance of bilinguals in their second language over their native as their results also showed that the claim for interpreters to better work into their native language was contradictory.

In 2006, an empirical study was carried out on the memory and language skills in simultaneous interpreters by Christofels, de Groot and Kroll (Christoffels et al. 2006) which compared the performance of trained interpreters to bilingual university students and to highly proficient English teachers. According to the outcomes, interpreters outperformed the college students in their speed and accuracy of language performance and on their memory capacity estimated from a set of working memory measures. The data in sum, according to them, point to (working) memory as a critical subskill for simultaneous interpreting.

The tradition of comparing interpreters with other non-native language commanders like bilinguals and monolinguals kept to be on focus and likewise, expertise in simultaneous interpreting on non-verbal executive processes was taken up by Carolina Yudes, Pedro Macizo and Teresa Bajo (Bajo et al. 2011). By analysing the results of simultaneous interpreters, bilinguals without any training in simultaneous interpreting and monolinguals as control group, the researchers revealed that experience in SI has positive impacts on executive processing but this advantage was only evident in executive functions directly included in the interpreting tasks. Interpreters seemed to possess more mental flexibility than bilinguals which might be associated with their skills to switch languages during interpreting and self-monitor themselves online. Huo Siliang’s MA Research Paper on Grammatical Performance in Simultaneous Interpretation (2005) attempted to confirm the hypothesis that interpreters found it difficult to avoid grammatical mistakes when translating into their non-native language due to the interference of their first language with the second one.

Before Golestani et al. (2008) and Bajo et al. (2011), expertise in simultaneous interpreting was also investigated by Liu (2001) where SI had been defined as the outcome of well-practiced strategies in each of the processes specific to the needs of SI such as comprehension, translation and generation and the interaction among these processes. Liu confirmed Dran and Fabbro’s (1991) results that expert interpreters

demonstrate a better ability to use flexible semantic processing than novice interpreters. Moreover, she added that this was probably due to the fact that experts have somehow learned to bypass the sub vocalization of the source text and that leaves enough space for other mental resources to execute processing. Notably, experts also demonstrated better ability to pay less attention to their own output which supported that simultaneous interpreters commanded well-practiced strategies allowing them to switch effectively between the comprehension, translation and productions processes.

The same year, Seeber (2011) described the amount of cognitive load during SI between structurally different languages such as English and German and suggested that simultaneous interpreting from SOV (subject-object-verb) language into the SVO (subject-verb-object) language produced more cognitive load than interpreting between SVO into SVO structured language pairs. Seeber and Kerzel (2011) then compared the results of this study with the data gathered from task-evoked pupillary responses used to measure online cognitive load during SI between verb final and verb initial structured language pairs. Results supported that the cognitive load increased towards the end of SOV constructions.

After Mecelli et al.'s (2004) voxel-based morphometry study on bilinguals and monolinguals revealed that the grey-matter density in the inferior parietal cortex was greater in bilinguals than monolinguals, Moser-Mercer and her team (Hervais-Adelman et al. 2014) compared the brain responses of 50 multilingual participants during simultaneous repetition (shadowing) and simultaneous interpretation by using fMRI to examine the neural basis of extreme multilingual language control. Results (See Figure 3) revealed activation of regions known to be included in speech perception and production and also "*a network incorporating the caudate nucleus that is known to be implicated in domain-general cognitive control*" and "*a significant modulation of the putamen by the duration of simultaneity*" (2004:1). Nineteen of these 50 students were trained as simultaneous interpreters for the next year while others were not and what final tests revealed one year later was surprising: Their caudate nuclei seemed to be less active during the interpretation task as against other tasks which means they became experts in controlling the process and mental multi-tasking. Researchers suggested that the caudate nucleus is actively involved in the selection and control of

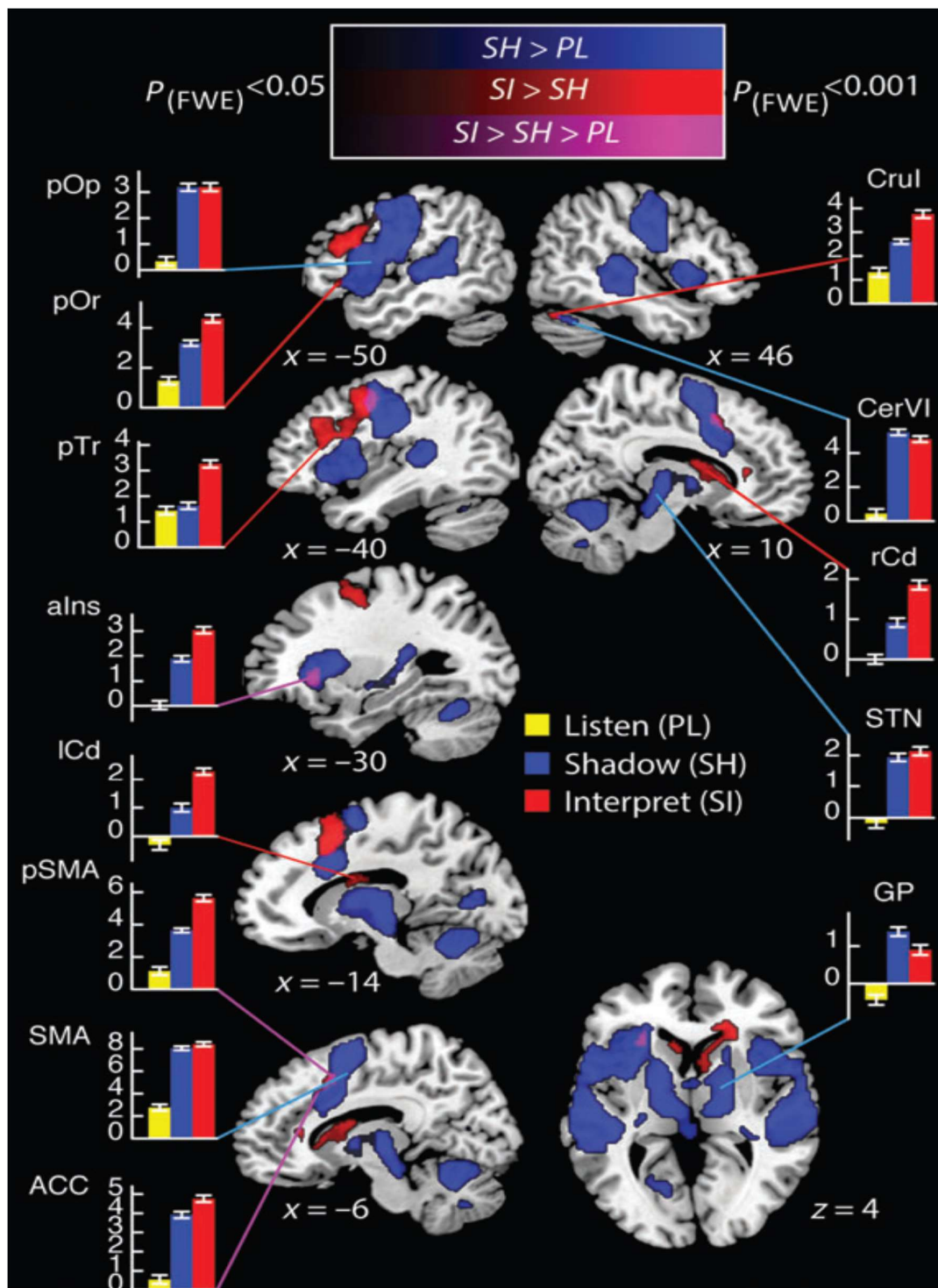

Figure 3. Significant differences in BOLD response for the contrasts Shadowing > passive listening (blue) and simultaneous interpreting > shadowing (red) (Golestani & Mercer 2014).

the lexico-semantic system while the putamen is included in the control of language production. This claim suggested Hill and Schneider's (2003) six themes about brain and learning which declared that learning causes structural and morphological changes in the brain such as increases and decreases in grey and white matter.

The most recent neurolinguistic investigation of simultaneous interpretation has been conducted by Moser-Mercer and her team and is expected to conclude in 2015 (Moser-Mercer et al., 2015). Based upon the existing functional brain imaging data on language switching and control in non-experts indicating the involvement of brain regions thought to be involved in translation and in the control aspects of speech, including the anterior cingulate and dorsolateral prefrontal cortices and maybe also regions involved in speech articulation, including the anterior insula, cerebellum, and supplementary motor area. The team expects to find experience-dependant changes in the shape and/or size of the above regions. However, contradictory data from a study comparing the grey matter volume of professional interpreters and multilinguals, on the other hand, provide the evidence for an "expertise-related grey matter architecture" that was still present before interpreting training (Elmer et al. 2014). Although some very significant insights exist on the brain plasticity of simultaneous interpreters, researchers need further neurological data on the subject to make concrete conclusions towards the structural and functional cortical changes in the brain due to expertise or training in simultaneous interpretation.

In this study, simultaneous interpretation and cognitive science are also correlated with each other as a working memory training task was used to measure the difference in the students' performance which has been strongly claimed to create new neural networks in the brain and in this way increase fluid intelligence. Results support the notion that the WM training may cause far transfer cognitive effects.

2.4. PROCESS MODELS OF SIMULTANEOUS INTERPRETATION

Many models developed up to this point are not generally limited to only one or two modes of interpreting. Yet, models developed towards the “process” are mostly designed for the simultaneous type of interpretation and the focus of attention is mainly multiple task performance, specific processing stages and mental structures and the common ground of these notions is that they are limited with the capacity of the working memory. It would be fair to say that all cognitive process models for SI included working memory as a major building block. Simultaneous interpretation demands highly advanced attention, listening, speaking, comprehension skills and a very strong control of executive functions such as blocking interfering information, eliminating distraction due to noise or any irrelevant information. Therefore, it goes without saying that a mammoth part of the SI performance relies on the capacity of working memory.

2.4.1. Gerver’s Model of Simultaneous Interpretation

One of the oldest information-processing models developed was that of Gerver’s (1976) and it was accommodating the existing data in simultaneous interpretation in a model that was based on the accumulated data from memory research (Dimitrova & Hyltenstami 2000: 67-68). According to this model, the two main aspects of the simultaneous interpretation process were permanent structural features including several types of memory systems and control processes carried out depending on the interpreter’s preference which would in turn help distributing attention to the related components (See Figure 4). This model was proposed in accordance with the results of a study including a series of experiments with professional interpreters. Gerver illustrates temporary storages (buffer storages) for different storages of text processing to get a continuous stream of input and output. These buffer storages were necessary for the storage of the information while interpreter was dealing with the operations of the previous segment. For the retrieval of the information stored in the buffer zone when required, the short-term operational memory would come into play.

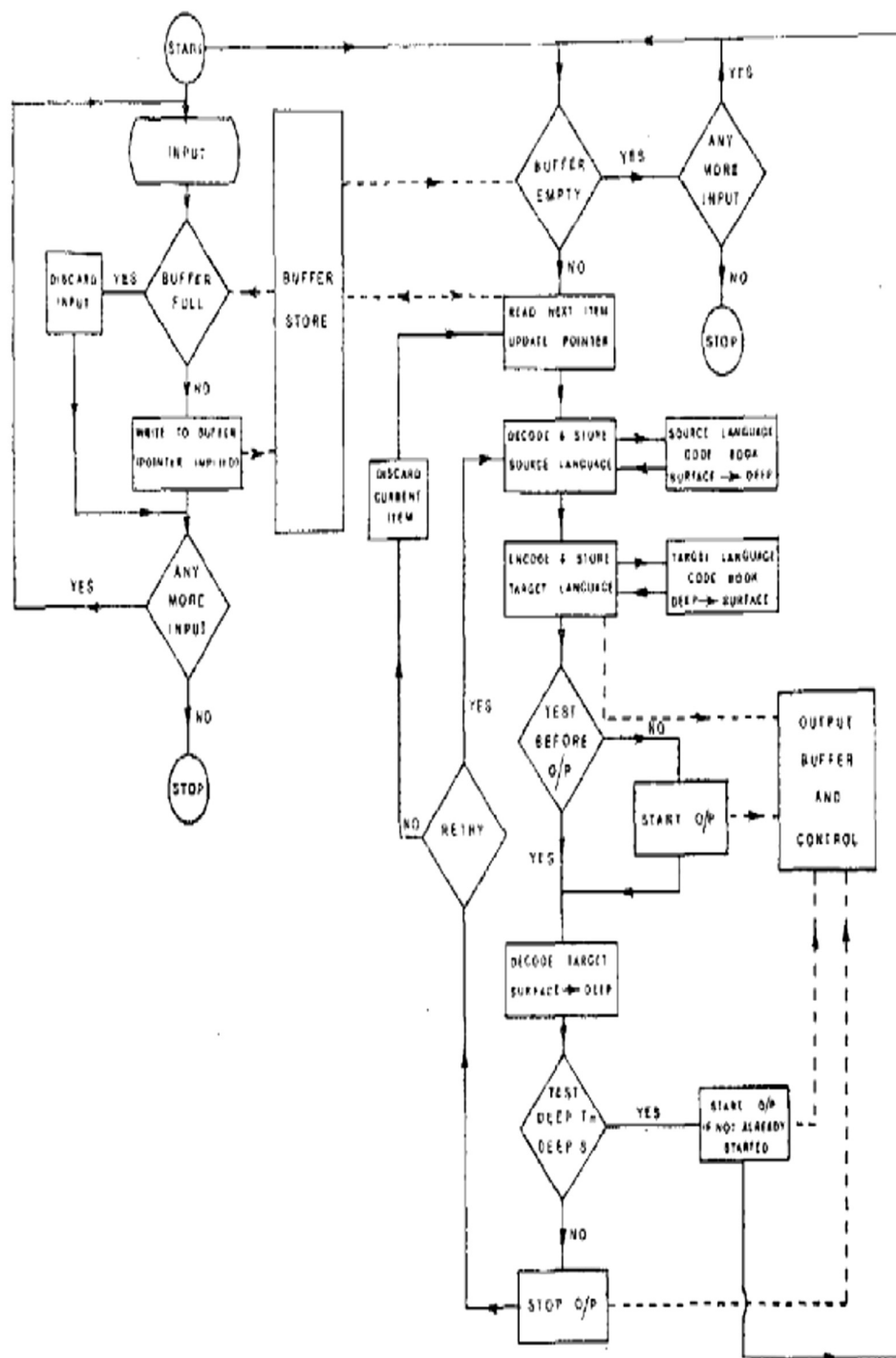

Figure 4. Gerver's Simultaneous Interpretation Model (1975)

According to Gerver, different stages of text processing occur in different short-term stores in cooperation with long-term memory. Source language input is received in the buffer storage and then processed according to the current state of the buffer zone and interpreter's preference. The processed text material goes through the decoding and encoding steps where phonetic representation within the components of the source language is analysed and reconstructed in the target language with the help of knowledge coming from the long-term memory into the short-term "working memory". After this linguistic processing is completed, the processed material is ready to be transmitted through the output buffer. Before producing the output, the interpreter may monitor her/his translation in terms of the quality and adequacy for a last pretesting or prefer generating his message immediately. If she/he chooses to produce it at once instead of discarding, she/he will still have enough memory on the content of the source message to make use of and the maintenance of the input in the working memory is for this reason crucial for later self-correction. However, if there is no such memory or the interpreter cannot make use of it appropriately, she/he will stop the generation or go for "reprocessing" or "back-tracking", or stop and continue generating if there is no such time for retrieval.

Gerver's model is the first model to involve both the short-term and long-term memory in the act of simultaneous interpreting and can be considered as modern with regard to the fact that it accommodates separate buffer zones for source and target languages but it conflicts with the new models of working memory assuming that each store serves a different modality. It is illustrated how information is stored for brief periods of time between input and output but it is not specified how the syntactic and lexical units are activated and included in the translation. Gerver uses the terms operational memory or working memory but does not include any identifications on the specific functions of the working memory. "Discard input" which implies the ignorance of the input when the input buffer is full is inconsistent with recent data showing that the selection of the upcoming items is carried out fundamentally due to the relevance of that information where the term "item" is also problematic as the definition of it is still open to controversies. Nevertheless, it is interesting as it stresses the existence of working memory within the translation process and how the entry is stored and delivered to other systems to make comprehension and production possible.

2.4.2. Moser's Model of the Simultaneous Interpretation Process

Moser's Model is based on Massaro's information-processing model of understanding speech (Perception Theory) (Massaro, 1987). It illustrates in detail the on-line temporal processing course of simultaneous interpretation with a flow chart diagram (See Figure 5). This model also emphasizes working memory, like Gerver, but she uses the term *generated abstract memory* (GAM) instead of working memory. The boxes included within the diagram exhibits structural components according to the kind of information stored through processing. Diamonds, on the other hand show the decisions made by the interpreter. Working memory has several crucial roles such as maintaining syntactically and semantically processed chunks, contributes to the paraphrasing and anticipation on the way to output generation in that it is highly associated with the long-term memory where mental lexicons and syntactic rules are stored.

The components of the model posited right in the middle of the diagram are postulated to be conducted in working memory and they receive continuous feed-back from long-term memory. Moser postulates that short-term memory relies heavily on the long-term memory because short-term memory has to get access to the information from long-term memory. The decision points encompass processing stages such as moving on or regressing to the previous stage. There is an intensive interaction between the immediate input processing and word knowledge combining with the novel input processing at every stage which supports the idea that her model further developed the speed of processing. Based upon the idea that anticipation and self-correction at all stages of comprehension and production, Moser presented a much detailed flow of information processing during simultaneous interpreting. The perception dimension seems to be developed in detail, yet there exist ambiguity in the production in that it is only identified as syntactic and semantic processing.

It depends on the processing rate of the interpreter if she/he can wait for more input to be received in order to generate a clear output or if she/he can take time to reprocess it to improve the message. It is always risky to keep the decalage longer than it should be while expecting more data to avoid ambiguity or to compensate an error because it may result in the decaying of the information. Units in the middle of the diagram which are

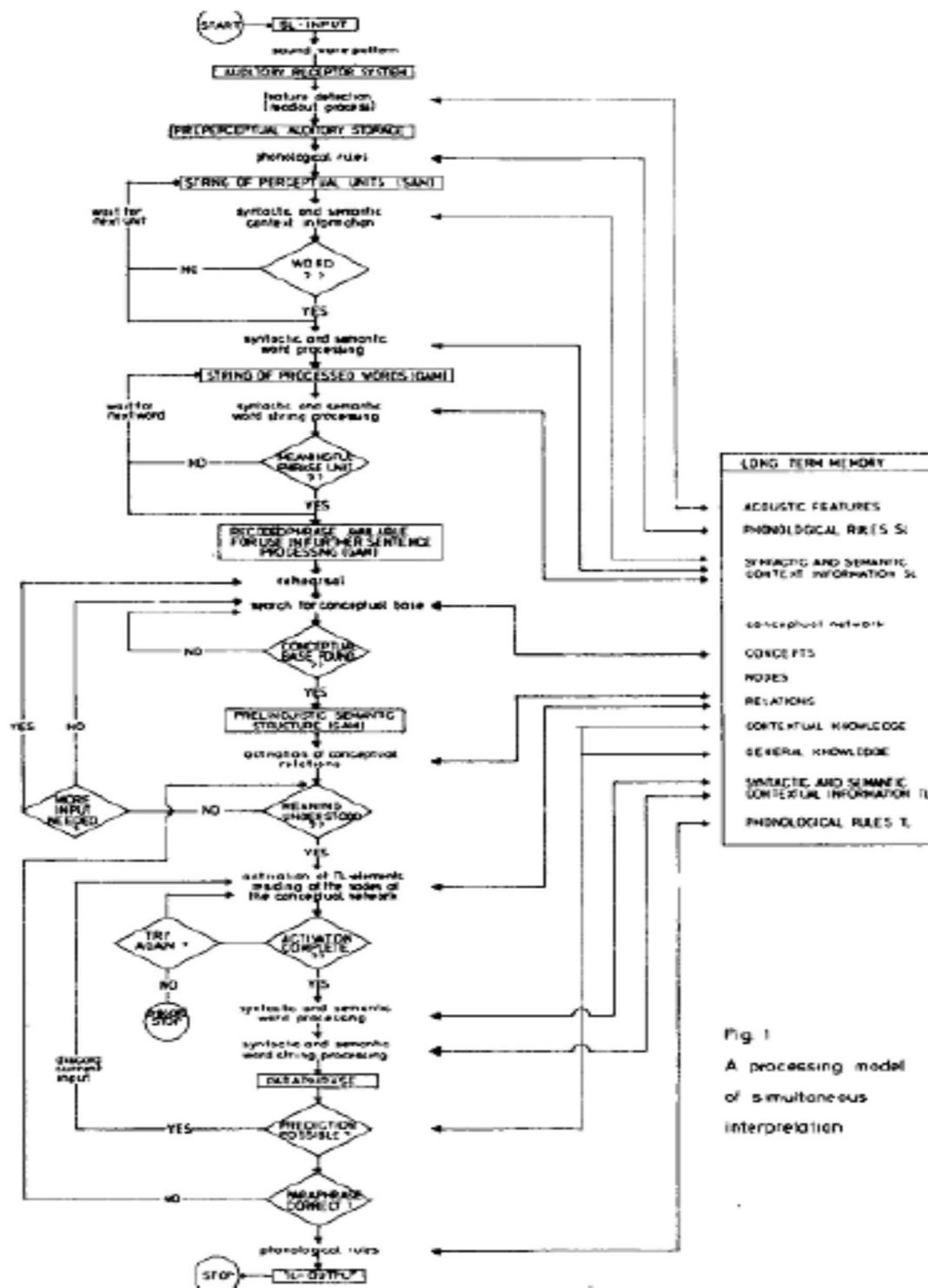

Fig 1
A processing model
of simultaneous
interpretation

Figure 5. A processing model of simultaneous interpreting (Moser 1978; Moser-Mercer 1997)

open to consistent access for feed-back play a crucial role especially in such situations when the interpreters prefers waiting for more input or improve the message because in that case, the process goes into the feedback loops. These loops enable the process to make a new circulation through the previous steps for the aim of upgrading the comprehension of the input or improving the message in the target language in case of any errors emerged at the end of self-evaluation.

2.4.3. Gile's Effort Model

Daniel Gile developed his Effort Models to contribute to the interpretation studies and help interpreters deal with the “difficulties [of interpreting] and select appropriate strategies and tactics” (Gile, 1992: 191). This model seems to be a bit more explanatory as Gile built this model to help interpreting students understand the tasks and processing capacities. His main ideas in this respect are that “interpretation requires some sort of mental ‘energy’ that is only available in limited supply” and interpretation “takes up almost all of this mental energy, and sometimes requires more than is available, at which times performance deteriorates” (Gile, 1995: 161).

According to this model, mental operations carried out during interpreting require some processing capacity and each phase the interpreter goes through is committed to an effort. The main idea here is that the interpreter should learn how to find the balance among these phases to make use of its capacity better. The efforts included in the simultaneous interpretation according to this model can be identified in three divisions. These are listening and analysing, production and memory efforts. The listening effort is mainly about the comprehension-oriented operations which cover the processes from the point that the source language reaches the ears of the interpreter and the meaning of combined words and sentences are recognized through the identification of the incoming sounds. The production effort corresponds to the operations carried out from the planning of the output message after the input is understood and analysed, to the delivery of it. The memory effort is the mental operations going on in the short-term memory when several parallel processes are needed to be successfully completed such as when the sounds of the source language input enters the ears of the interpreter and the

understanding of the message is completed, and the planning of the message in the target language is made at the same time and it is delivered through the microphone. For all these steps to be carried out, interpreter needs to store the information for a short-period of time while following the speaker behind a time-lag among the tactical moves used to make any kind of unclear information concrete enough to form an adequate and correct sentence and the linguistics reasons. (Gile, 2002 162-163)

This model fundamentally depends on the fact that processing can take place with a limited amount of mental energy and the interpreter tries to divide this effort equally to each of these efforts so that a balanced processing can be achieved. These efforts deal with different segments (Gile 1995: 170) instantly and Gile refers to the results of simultaneity as “tightrope hypothesis” which refers to the fact that interpreters work close to the processing capacity saturation, which makes them vulnerable to even small variations in the available processing capacity for each interpreting component” (Hansen, 2008:86-87). The tightrope hypothesis is supported by Fabbro and Gran’s neurological data claiming that the brain areas activated during simultaneous interpreting were much different and large scaled than that of normal language production in terms of cerebral lateralization (Gran and Fabbro, 1997: 21-24). The coordination effort was added to this model as a new component later by Gile to present the self-monitoring and focus of attention of the interpreter between the listening and analysis task. This effort is of vital importance as the interpreter is supposed to perform the task in the most appropriate environment within optimum conditions only if the balanced monitoring and processing of the parallel tasks are achieved via this coordination effort. Within this framework, the simultaneous interpretation task can be modelled as the combination of three components with the addition of a coordination effort with the equation below:

$$SI = L + P + M + C \text{ (Eysenck and Keane 1990).}$$

In this case the total processing capacity requirements (TR) for the interpreter is thus expressed as:

$$TR = LR + MR + PR + CR,$$

where LR stands for the capacity requirements, MR for capacity requirements for memory, PR for capacity requirements for production and CR for capacity requirements for comprehension. Since the “...*processing capacity requirements for each effort can vary rapidly over intervals of a few seconds ...*” (Pöchhacker 2004:165) and “...*the capacity available for each effort must be equal to or larger than its requirements for the task at hand*”. As a consequence of this, the interpreter needs to satisfy the equation of

$TA > TR$ where TA means the total available capacity and TR stands for the total requirements to complete the task successfully and

$$TA > LR + MR + PR + CR,$$

where R means “requirements.”

To summarize it, this model’s primary function is to review the errors and omissions observed during the task which were apparently not due to any lack of acknowledgment in terms of linguistics, extra-linguistics abilities or deficiency in the quality of the source text. Briefly, Gile claims that the available cognitive processing capacity is limited and the sum of the efforts mentioned above must be less than the available processing resources. If the second and third conditions are not provided, it would cause a negative impact on the interpreting performance and the coordination effort would come into play to compensate and improve the quality of the output. In this sense, simultaneous interpretation seems to be an activity much more associated with cognitive science rather than a context-dependent one.

2.4.4. Process Model by Valeria Daro and Franco Fabbro

Daro and Fabbro based their findings from psychology and memory to propose a more recent model for simultaneous interpreting which underlines the working memory component and complies with today’s memory systems. Long-term memory and working memory are included as further subdivided systems and working memory system is based on the principles of Baddeley and Hitch’s model (Hitch, 1990) already mentioned above. In

line with the data they received from experiments on verbal memory and phonological interference during simultaneous interpretation, they concluded that the processing of the SL started before the translation process (See Figure 6).

The model assumes two memory systems as Working Memory and Long Term Memory and the working memory system adopted from Baddeley and Hitch's model is in fact partially adopted because only the verbal slave system and the central executive component of it is utilized. It is interesting that the working memory serves as a channel for SL input within this model. In other words, it functions as a passive store of the SL, but the TL limits the capacity of working memory by interfering with this function. They also adopted the central executive but did not attribute any specific function to this component unlike Baddeley and Hitch. The translation processes are performed by two separate language into the native language and the other in the opposite direction during translation modules where each module works in one direction primarily, one from the non-native

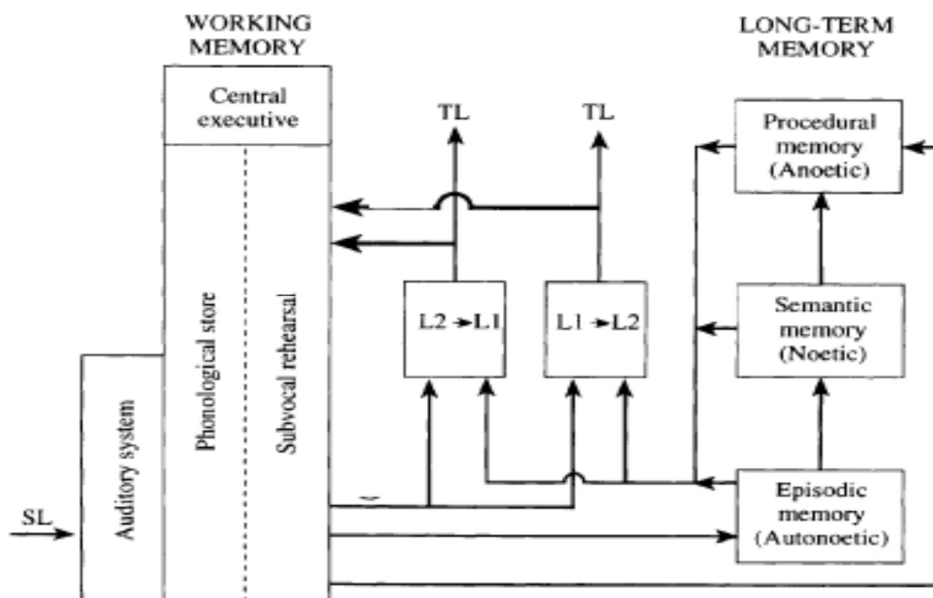

Figure 6. A general model of memory during simultaneous interpretation (Daro and Fabbro 1994)

language into the native language, and from the native language to the non-native language. According to the data they gathered from experiments on verbal memory and

phonological interference during simultaneous interpretation, they also concluded that verbal chunks could be held for about 10 seconds before being further processed or otherwise fading away. These verbal chunks at this point can either be moved to the translation systems or to the procedural, semantic or episodic (autonoetic) memory embedded in the long-term memory to be stored. They add that long-term memory contributes to the neurofunctional systems responsible from the translation process and reduced recall is partially due to phonological interference from TL message with sub vocal rehearsal procedures in working memory (Hauenschild: 12).

Interpreting process models selected and explained in this study all notably assume working memory to be located at the centre of the interpreting process, yet they attribute different specific tasks to working memory during simultaneous interpreting. Gerver conceptualize working memory as a passive store of verbal input like Darò and Fabbro who also make use of the concept of working memory only as a storage component. Different from these two models, model by Moser (1978) attributes many crucial coordination and executive functions to it although it is not clear if working memory itself is directly performing these tasks or it is assisting the independent structural bodies. Interpreting process seems to be dependent on the working memory, long-term memory and independent translation entities while Moser assumes working memory as the fundamental mechanism for interpreting.

2.5. WORKING MEMORY

The modern concept of Working Memory was first proposed by Baddeley and Hitch (1974) as a modification of the concept of short-term memory due to a need to make a solid distinction between their fundamental functions in the brain. Yet, working memory is not completely different from short-term memory. It refers more to the whole theoretical framework of structures and processes used for the cognitive component combining temporary storage, cognitive processing and manipulation of the information at hand over brief periods of time whereas short-term memory is a simple store of information. In fact, William James (1890) identified short-term memory storage as *primary memory* and following research has proven that this storage of

information had a very limited capacity. Later, Miller (1956) declared a very popular idea regarding short-term memory capacity which suggested that humans can remember items up to seven plus or minus two “chunks”, which would be referred to as the “Miller’s Law” later on. However, it was not until Baddeley and Hitch challenged Atkinson’s and Schiffrin’s unitary view of short-term memory (1968) with a multi-compartment model that the concept of working memory has turned out to be one of the most popular research subjects in cognitive science and interpreting studies.

Baddeley and Hitch introduced their Model of Working Memory in 1974 which included a central executive for directing attention and coordinated processes and the flow of information into other systems. It was primarily associated with decision-making, problem solving and attention. The central executive also coordinated two slave systems called the phonological loop, which stores auditorily presented verbal information by protecting it from decaying via continuous sub vocal articulation and the visuo-spatial sketchpad, where the visual and spatial information is stored for the manipulation of visual images and representation of mental maps. Nelson Cowan (2001), on the other, hand illustrated working memory not as a separated system but within the short-term memory. Baddeley (1975), depending on the empirical finding, suggested that verbal information could be stored in the phonological loop for approximately 2 seconds, therefore people can remember as many words as they can pronounce in two seconds.

Ericsson and Kintsch (1995) proposed another approach for working memory in which they underlined how experts used their memories in daily tasks like playing chess, reading and comprehension. They suggested that experts needed more than seven chunks while playing chess or when trying to understand the theme of a text. They added that experts managed doing these everyday tasks because they stored only a few concepts in working memory as it has a fixed storage capacity and most of the information in long-term memory can be associated between these two memories through retrieval structures. They point out that the amount of information can exceed the traditional STM capacity because it is stored in LTM and that is the reason why it is durable as being less open to interference and disruption in here. Mechanisms used to retrieve information are assumed to be maintained in short-term memory and they are

predicted to be subject to some limitations such as interference and decay like other non-familiar info is but they make no clear assumptions towards the cues that can be maintained active simultaneously and do not predict how long these cues can be kept active.

In line with Ericsson and Kintsch, Nelson Cowan proposed a third approach called “Activated Long-Term Memory” in which working memory is an activated part of the long-term memory and the term short-term memory is used rather than working memory. Cowan (1995) illustrated a long-term memory including an activated subset of items that were also contained in the working memory, which consisted of two embedded levels called activated long-term memory representations (short-term store) and the focus of attention. He grouped the memory tasks as short-term memory tasks which were referred to as the tasks associated with the passive storage of information where stimuli were simply kept and working memory task which was related much more to the manipulation of the information stored. The short-term store (activated memory) and the focus of attention is a subset of long-term store. In activated memory, there are highly activated items available for processing only through the focus of attention. Thus, information in long-term memory is not active and to become active, they need to receive enough attention from activated memory and this way move to the focus of attention. The focus of attention directs attention and responsible for voluntary processing. He defined that the capacity of focus of attention corresponds to approximately four items and the capacity of activated memory depends on whether active rehearsal is prevented or maintained which also takes place in the focus of attention. Recently, Oberauer and Goethe (2006) has further developed Cowan’s model, especially in terms of the mechanism of focus of attention.

In 2000, Baddeley and Hitch’s model of working memory (1974) has been updated and a new subsystem has been added – episodic buffer (Baddeley 2000), which had previously been eliminated from the model back in 1986 (Baddeley, 1986). Different from the other two slave systems, the phonological loop and the visuo-spatial sketchpad, the episodic buffer is a storage for “multi-modal” information which means that its function is not limited with specific modalities and it coordinates and controls the flow of information coming from other subsystems. It helps creating representations

that integrate visual, spatial, phonological and semantic information to make a unitary episodic representation (Figure 7).

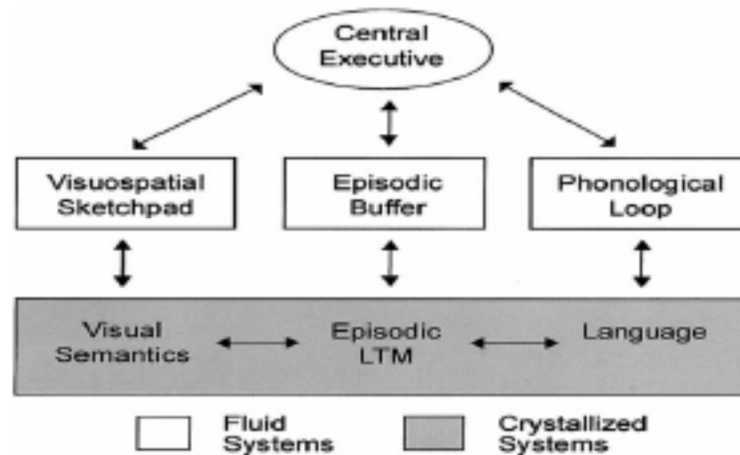

Figure 7. The multi-component working memory model (Baddeley, 2000)

This addition of this slave system was claimed to be necessary as there existed some problems according to Baddeley (2000) such as the short-term memory of features like semantic information that was not included within other stores, the interface with working memory, or recalling links between names and objects or faces or coherence of a text by the retention of complete sentences instead of lists of words that was beyond the capacity limitations of the phonological loop. Central executive component was mainly responsible from coordinating information, strategy planning, reasoning, response inhibition, attentional control and goal maintenance and according to this model, WM system can store, maintain, retrieve and update information while manipulating memory items for completing the task properly (Clouter 2013:11). The episodic buffer is also controlled like other sub-systems by the central executive, which determines its content depending on the information source.

Each model postulates a different view on the capacity of working memory (short-term memory) and they all have a different perspective on the theoretical framework of the general concept. While Baddeley's model stresses the characteristics and identification of components by declaring that working memory is an entirely separate institution with

its own infrastructure, which plays a significant role on cognitive performance, the model by Ericsson and Kintsch and Cowan seems to be handling functional processes in that they evaluate working memory as a combination of mechanisms which enable short-term storage of task-relevant information. They are focused more on the processing of information rather than naming stores according to their properties. According to them, working memory can get support from any neuroanatomical structure available depending on the information attended to. They also differ in the view on the neuroanatomical dissociation of working memory and long-term memory, although they are accepted to me definitely separate from each other conceptually. Models also attribute different roles to their central executive components. While in Ericsson and Knitsch, performance requiring expertise are supposed to be executed depending on previous experience by making use of cues and strategies, executive component seem to be more significant for Baddeley and Cowan. Unlike Ericsson and Knitsch, they relate this component to be responsible from controlled attention, which has been demonstrated by many theorists to be highly associated with working memory (Timarova 2008: 10).

2.5.1. Capacity and Importance of Working Memory

Capacity of working memory is subject to controversies still today and the concept itself may easily be qualified as novel and the development has been progressing. As defined in the previous chapter, there exist different views on the capacity of working memory. Baddeley suggests that verbal information can be stored in the phonological loop for nearly 2 seconds but the material maintained depends on the articulation rate of the individual. Cowan (1999) proposes that items in activated memory decay within 10-30 seconds provided that they are not rehearsed and items in the focus of attention are limited to approximately 4 in total but can be maintained in attention for relatively longer time. Ericsson and Delaney (1999) declare no limit for the items activated, they emphasize cues for retrieval included in short-term memory as mentioned previously. However, it is now known that it is not fixed to seven items and may differ from person

to person. The WM capacity declines with aging (after 25-30 years of age) and 5-10% per decade is accepted as a normal recession.

As Baddeley (2003) defined, WM is crucial for several cognitive tasks which require the maintenance of information in mind such as language acquisition. Several other studies also showed that it might be a very crucial factor in determining general intelligence (Kyllonen & Christal, 1990; SüB, Oberauer, Wittmann, Wilhelm, & Schulze, 2002). In his “Working Memory Training Literature Review”, Smith defines WM as the core brain function critical for all high-level cognitive skills (flexible problem solving, critical thinking, decision-making and comprehension) and illustrates it as the main control centre of human cognition (See Figure 8) referring to the explanations made by the brainSCANr considering relationships between working memory and different cognitive functions and brain regions. He states that working memory is required to maintain attention, eliminate distraction and keep the mind updated and identifies it as a set of skills to enable us to store information in mind while carrying out a task. Some high level skills associated with working memory are reading comprehension (Just & Carpenter, 1992) and arithmetic (Gathercole, Pickering, Knight, & Stegmann, 2003).

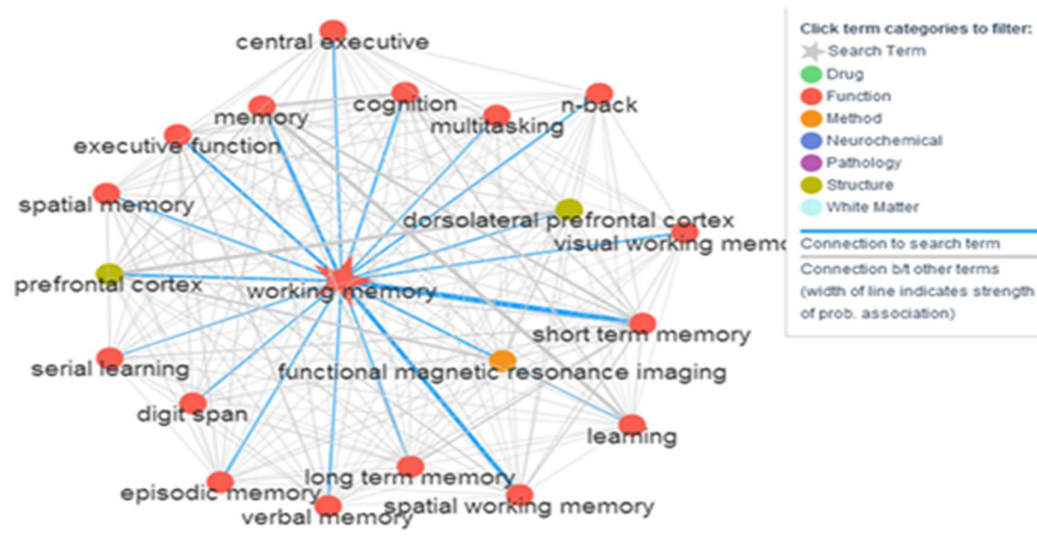

Figure 8. Connections of Working Memory (from BrainScanr)

Shah and Miyake (1999) suggested that WM is essential for all complex cognitive abilities and another study showed that when doing arithmetic, reading a complex paragraph, listening to a lecture while following the social media on the phone at the same time, one is dependent on his working memory (Jonides et al. 2008). In 1990, Kyllonen and Christal found that WM is closely related to various high-level cognitive abilities such as reasoning, problem-solving and learning. It is also related to academic achievement concerning reading (García-Madruga et al. 2013; Daneman & Tardif 1987 and Daneman & Carpenter, 1980), attentional tasks and resistance to distraction (Fukuda & Vogel, 2009; Fukuda & Vogel, 2011), acquiring new skills (Pickering, 2006), writing (Abu- Rabia, 2003), academic success (Alloway 2004) mathematics and science (Witt, 2011, De Smedt, Ghesquiere & Verschaffel, 2004; Gathercole, Pickering, Knight & Stegmann, 2004) and language acquisition (Baddeley, 2003). These psychological studies seem to be in line with the results of neuroimaging studies relevant stating that subjects having a higher working memory capacity can “filter out” any interference (irrelevant information) or distraction better because it is the prefrontal cortex enabling this “filtering” function and activity in this region is known to be directly associated with higher WM capacity (McNab and Klingberg, 2008). Additionally, accumulating data also point out that individuals with better working memory are less likely to keep irrelevant information in attraction (Vogel et al., 2005).

The cognitive neuroscience of working memory has also made strides by making use of latest technology to measure human’s brain activity. New techniques let researchers to bring knowledge from cognitive psychology and neuropsychology together and various studies have illustrated that the activation of working memory while the information is kept in attention causes prefrontal and parietal activity. Training of working memory has also exhibited the activation of basal ganglia, prefrontal and parietal cortex (Olsen, Westerberg & Klingberg, 2004). However, the debate on the brain areas included when different types of working memory are activated continues. A meta-analysis on 60 neuroimaging (PET and fMRI) studies of working memory (2003) suggested “representation in the frontal cortex are organized by process rather than material type and executive demand produces reliable activations in regions largely in the frontal cortex but also quite consistently in the superior parietal cortex.” (Wager et al. 2003)

Results also revealed that continuous updating produced more activation in frontal cortex than dual tasking.

Since studies all set light to the fact that WM is included in a very wide range of cognitive tasks, it is not surprising to find out that impairments in working memory can result in several clinical disorders which could be stemming from stroke, traumatic brain injury, attention-deficit/hyperactivity disorder (ADHD), schizophrenia and mental retardation. As a consequence of such WM disorders, many high and low order skills might be affected such as reading, focusing, and learning due to the impairment of the neural systems underlying working memory. Yet, improving working memory capacity as a treatment of cognitive impairments and an opportunity for academic achievement has become the turning point of various disciplines for the last decade. It has also been the focal point of interpreting researchers carrying out investigations in neuroscience and cognitive science since now they have the wide range of possibilities the latest neuroimaging technology such as PET and fMRI has provided them to monitor the impacts of working memory on simultaneous interpreting.

2.5.2. Training of Working Memory

People differ from each other with regard to the information they can maintain in their working memory or how well they can eliminate distraction (Engle et al. 1999). After the evidence on the idea that some WM interventions may cause generalizing effects also on the non-trained domains which is called “transfer” has spread (Morrison & Chein, 2011; Rabipour & Raz, 2012; Zelinski, 2009) researchers focused on this transfer effect. Earl Butterfield and colleagues conducted a series of studies on “The Theory and Practice of Improving Short-Term Memory” for improving the short-term capacity of learning-disabled people (Butterfield et al. 1973) in which they taught subjects to make use of subvocal rehearsal. Results of the studies were positive in that individuals could improve their working memory but no evidence was reached concerning the transfer of this improvement to non-trained cognitive tasks. Later on, Ericsson and colleagues showed that one can improve the number of digits he can remember by practicing (Ericsson et al. 1980). One participant was especially worth

mentioning for he was able to remember up to 79 digits by grouping numbers with the items in long-term memory, which is an instance of “chunking” mentioned in this study previously. However, he could not perform the same success with letters which was a clear proof of the fact that his improvement was only specific to the material.

On the other hand, recent data on the transfer of non-trained skills revealed that training may cause changes also in the non-trained working memory tasks. Klingberg, for example, (Klingberg, Forssberg, & Westerberg, 2002; Klingberg et al., 2005) by showing the results of a computerized, adaptive training for 25 days, reported that the training effect generalizes also to non-trained working memory tasks and to cognitive tasks known to be intensively associated to working memory. Other researchers conducted research on measures of intelligence (Carretti, Borella, Zavagnin, & de Beni, 2013, Jausovec & Jausovec, 2012, Rudebeck, Bor, Ormond, O’Reilly, & Lee, 2012; Stephenson & Halpern, 2013; Takeuchi, Taki, Nouchi, Hashizume, Sekiguchi, Kotozaki and Kawashima, 2013; von Bastian & Oberauer, 2013) and this discussion has been then sparked by Jaeggi, Buschkuhl, Jonides and Perrig (2008) when they showed that WM training can in fact increase fluid intelligence. They also exhibited that more training caused greater IQ gains.

Yet, the effectiveness of WM training is in its infancy. Most researchers are getting positive result in terms of improving the capacity, however, research on transfer effects is controversial. Some studies report no effects at all (Zinke, Zeintl, Eschen, Herzog & Kliegel, 2011), while some researchers get inconstant results (Redick, Shipstead, Harrison, Hicks, Fried, Hambrick and Engle, 2013; Anguera, Bernard, Jaeggi, Buschkuhl, Benson, Jennett, & Seidler, 2012).

One of the latest studies on this regimen was again by Jaeggi and her colleagues (Jaeggi et al., 2014) which aimed to find evidence on transfer of improved WM into more general cognitive domains, in this study- fluid intelligence by taking up one of the latest and most popular WM training tasks: the n-back task. They included 20 studies meeting their criteria such as the inclusion of a control group, motivation and payment, and reported a positive result which suggested that dual n-back task results in the improvement of fluid intelligence (Gf). In accordance with their results the authors concluded that future studies should aim to find out more about the nature and extent of

how the improved test scores reflect true increases in intelligence instead of questioning the transfer.

2.5.3. General Benefits of WM Training

Some intervention studies concerning working memory focused on the attention and executive functions of WM. Rueda and colleagues, for instance, found increased intelligence only for 4 years olds in a study including 4 and 6 years old children after training (Rueda, Rothbart, McCandliss, Saccomanno & Posner, 2005) and a larger study based on the reasoning, planning and attention components of WM found no transfer effect after a 6-week training (Owen, Hampshire, Grahn, Stenton, Dajani, Burns, Howard & Ballard, 2010). Therefore it might be fair to say that it is somehow not clear to make the last decision on which condition effects of WM training causes transfer to general intelligence (Gf).

On the other hand, another study published in the Journal of Neuroscience in 2010 (Takeuchi et al., 2010) including dual n-back variants notably exhibited an increase in the distribution of the white matter in the brain and these changes were associated with the WM training, namely n-back training. That study was supported by the data revealed by Klingberg and colleagues (2004) with a study on increased prefrontal and parietal activity after training on WM where they concluded that such training based improvement in WM could be linked to neural plasticity. In another study by Westerberg and Klingberg (2007), authors stated that practice on WM tasks resulted in an improved performance for several months and the effects of training also generalized to a non-trained WM task. They also reported a relative increase in the activation in the middle and inferior frontal gyrus which are known to be related to WM brain activity. Rueda and colleagues (2005) found strong improvement in executive attention and intelligence in children between 4 and 6 years where efficiency of attentional networks across ages was examined with a 5 day of attention training.

It has been shown in a number of studies that circuitry in the dorso-lateral prefrontal cortex is changed as a result of working memory training, with long-term

neuroplasticity synaptic modifications (McNab, 2009). Another study demonstrated a large overlap of Gf and WM span brain mechanisms when interference control is required in a task with neuroimaging (Burgess, Gray and Braver, 2011). They reported that brain regions common to Gf, interference control and WM became more active when the need for overcoming distraction is increased as shown in Figure 9 (See Figure 9). According to this study, these areas were the lateral prefrontal cortex and parietal cortex in both hemispheres. Olsen et al. (2004), on the other hand reported increases in frontal and parietal activity after training of WM (See Figure 9b.)

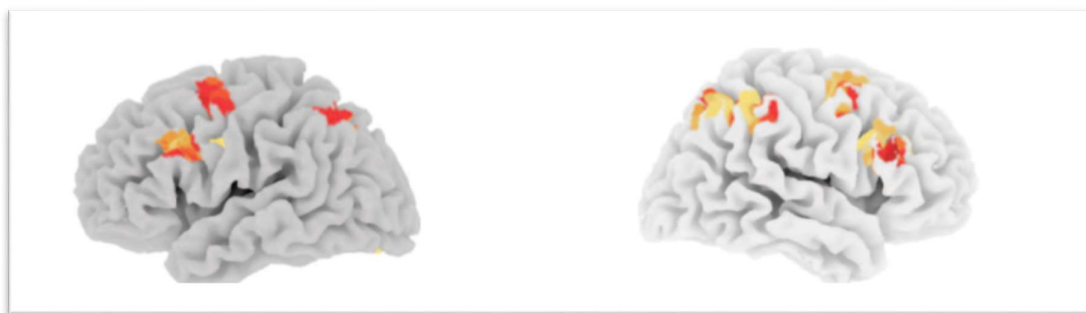

Figure 9a. Brain regions underlying interference control, working memory capacity and Gf, Burgess (2011)

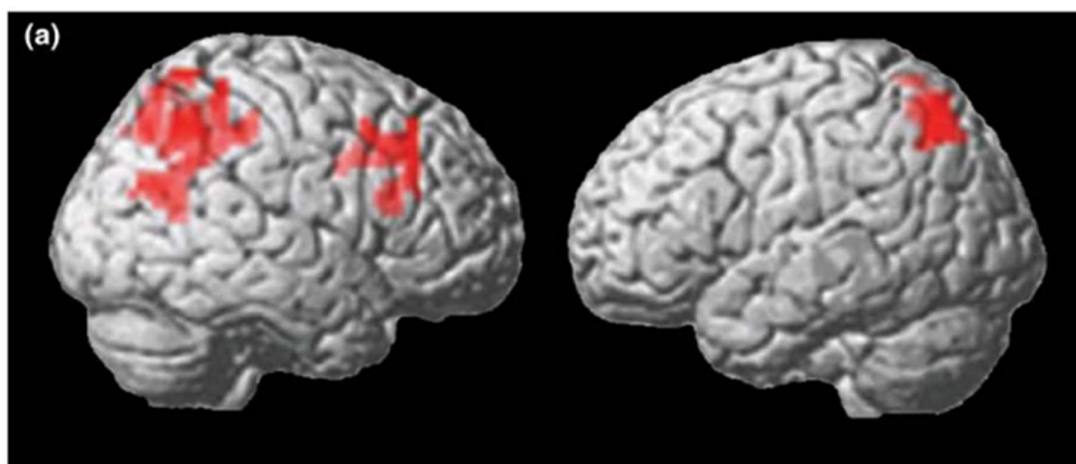

Figure 9b. Increases in frontal and parietal activity after training of WM (Olsen et al., 2004)

Hujiber's study on learning new information and recalling old information (Hujiber et al., 2008) investigated the neural mechanisms underlying the connection between learning and remembering old information with functional neuroimaging (fMRI) and reported mid-ventrolateral prefrontal cortex activation in resolving the memory competition "possibly by facilitating rapid switching between learning and remembering." Conway published another study on WM capacity and general intelligence (Conway, 2003) where he stated:

"Several recent latent variable analyses suggest that (working memory capacity) accounts for at least one-third and perhaps as much as one-half of the variance in (intelligence). What seems to be important about WM span tasks is that they require the active maintenance of information in the face of concurrent processing and interference and therefore recruit an executive attention-control mechanism to combat interference. Furthermore, this ability seems to be mediated by portions of the prefrontal cortex." (Conway, 2003: 550)

In 2008, Jaeggi and colleagues published a study on "*Improving fluid intelligence with training on working memory*" (Jaeggi 2008) where they concluded that in contrast to many studies previously conducted, it is in fact possible to improve general intelligence (Gf) without practicing the testing tasks and that the training effect was "*dosage-dependent*". The duration of these gains are not known but this study can be referred to as one of the most significant studies concerning dual n-back training as it has become a hot topic among other researchers. Qui (2009) also supported the idea that Gf can be improved by dual n-back training. Following her previous studies on dual n-back training, Jaeggi (2010) published another study on single n-back training where the improvements achieved with the single n-back and dual n-back training were compared and it was revealed that the same improvement in Gf was yielded also with the single n-back task but the transfer effects on WM capacity were relatively less.

In 2010 and 2013, Stephenson (Stephenson et al. 2010, Stephenson et al. 2013) argued whether dual n-back task training programme actually improved Gf or only the attentional control and visuospatial skills. Another study by Clouter (Clouter 2013) investigated the effects of dual n-back training task on a variety of Gf measures, reasoning, WM span and attentional control and claimed that

further investigation is needed to understand what conditions are responsible from the transfer caused by the training in question.

Based upon the fact that some studies cannot prove far transfer effects and thus suggesting that the generalization effects remain inconsistent, Jaeggi (Jaeggi et al. 2013) focused on individual differences in cognitive training and its role in the transfer effect in parallel with Clouter's study. The results replicated earlier findings of transfer from training by n-back task and authors reported that factors such as motivation, pre-existing ability and need for cognition also had an impact on the success achieved from WM interventions. The most recent studies conducted up to date were by Horvat (Horvat, 2014) where experimental group was subject to adaptive dual n-back task and results revealed that they were relatively better at the Gf measures than the control group after training and by Buschkuehl et al. (2014) where 7 days of training on a n-back task seemed to lead to improvements in trained tasks and also in non-trained modalities.

In contradiction to these studies, Redick et al. (2012) and Rudebeck et al. (2012) failed to find any transfer to any of the cognitive ability test where they used dual n-back task as a training. Thompson et al. (2013), also failed to support the idea that adaptive dual n-back task training improves WM capacity in non-trained tasks such as Gf and other cognitive skills where healthy young adults were assessed. Oelhafen et al. (2013), also failed to find any transfer to measures of WM and Gf in a study where they examined training on two variant of the adaptive dual n-back task would affect untrained task performance and Colom et al. (2013) concluded that n-back training does not improve Gf at the construct level. Therefore, an overview of the data gathered up-to-date urges the researchers to further investigate the WM trainings and their permanent effect on the intelligence and other cognitive skills.

2.6. WORKING MEMORY IN SIMULTANEOUS INTERPRETATION

Simultaneous interpreting is particularly assumed to be a demanding task considering the cognitive resources like attention and working memory which are thought to be gradually improved with professional experience and practice. Based upon the idea that the simultaneous interpreting task requires advanced memory and skills (e.g. Hulme 2000) many studies towards testing working memory skills in professional interpreters were conducted with the rationale that such skills develop during training. Based upon this assumption, most studies were constructed on comparing the memory performances of novice and professional interpreters. And most of these studies made use of memory span measurements to reflect the WM capacity. These studies are illustrated in the table below (See Table 1). As might be seen from the table, the first study focusing on short-term skills in simultaneous interpreting was conducted by Daro and Fabbro (1994). With the aim of exhibiting that the interpreting task required complex cognitive skills, authors reported the results of their study showing the performance of 24 interpreting students with average 29 months of experience in a series of digit span tasks in listening, shadowing, articulatory suppression and simultaneous interpretation. Results showed that participants had a relatively lower performance after simultaneous interpretation which proved that interpreting has a disrupting effect on the concurrent task due to phonological interference experienced. Based on the data, authors concluded that long-term professional training in simultaneous interpreting results in a better ability of resisting to phonological interference in short-term memory tasks.

Another digit-span study by Padilla (1995) included bilingual participants with experience in SI who ranged in the years of experience and a classical digit span test was used where participants were presented a series of digits either visually or auditorily and participants needed to recall the digits in the right order. These groups consisted of interpreters, interpreting students and bilinguals with no professional experience or training. According to data, the interpreter group had an average of 7 and higher digit span while other groups could make it around 6 and above. The difference

Key for word-stimulus papers

1 = Relative to what is reported in the general span literature

2 = Pattern of superior interpreter performance

3 = Scores not reported, so pattern direction judgment cannot be made

4 = Student interpreters significantly better. Professionals had a pattern in the direction of better performance relative to controls.

5 = For second-, not first-year interpreting students

PSI = Professional simultaneous interpreter

NIM = Non-interpreter multilingual

Article	Participants	Language of testing	Context	Auditory stimuli	Print stimuli	On par performance	Superior interpreter performance
Word-span Tasks							
Darò & Fabbro (1994)	Student interpreters	L1/L2	Normal	Digits			✓ ¹
Chincotta & Underwood (1998)	Student interpreters, NIMs	L1/L2	Normal Articulation suppression		Digits	✓ ² ✓ ²	
Padilla <i>et al.</i> (1995)	PSIs, student interpreters, NIMs	NA	Normal	Digits			✓
Christoffels <i>et al.</i> (2006)	Interpreters, bilingual students, English teachers	L1/L2	Normal		Words		✓
Köpke & Nespoulous (2006)	PSIs, student interpreters, multilinguals, monolinguals	L1	Normal	Words		✓ ²	
Tzou <i>et al.</i> (2011)	Student interpreters, NIMs	L1/L2	Normal	Digits			✓ ⁵
Word-list Recall							
<i>Free Recall</i>							
Padilla <i>et al.</i> (1995)	PSIs, student interpreters, NIMs	NA	Normal Articulation suppression		Words	✓ ²	✓
Köpke & Nespoulous (2006)	PSIs, student interpreters, multilinguals, monolinguals	L1	Normal Articulation suppression	Words		✓ ³	✓ ⁴

<i>Final Recall</i> Padilla <i>et al.</i> (1995)	PSIs, student interpreters, NIMs	NA	Normal Articulation suppression	Words	✓ ²	✓
<i>Cued Recall</i> Köpke & Nespoulos (2006)	PSIs, student interpreters, multilinguals, monolinguals	L1	Normal (Non-articulation suppression)	Words Phonological cues Words Semantic cues	✓ ³ ✓ ²	
Signorelli <i>et al.</i> (2011)	PSIs, NIMs	L2		Words Phonological cues Words Semantic cues	✓ ² ✓ ²	
Related Word-Stimulus Tasks						
<i>Non-word Repetition</i> Signorelli <i>et al.</i> (2011)	PSIs, NIMs	L2	Normal	Words		✓
Key for phrase-stimulus papers						
1 = New students had just begun interpretation study						
2 = Pattern for better performance with more interpreting experience						
3 = Only student interpreters had significantly better performance than controls. Students and professionals did not differ.						
PSI = Professional simultaneous interpreter						
NIM = Non-interpreter multilingual						
Phrase Span						
(This is a collective term. Different studies also used labels such as reading and listening span)						
Article	Participants	Language of testing	Auditory stimuli	Print stimuli	On par performance	Superior interpreter performance
Padilla <i>et al.</i> (1995)	PSIs, student interpreters, NIMs,	NA		✓		✓
Liu <i>et al.</i> (2004)	PSIs, advanced student interpreters, new students ¹	L2	✓		✓ ²	
Christoffels <i>et al.</i> (2006)	Interpreters, bilingual students, English teachers	L1/L2		✓		✓
Köpke & Nespoulos (2006)	PSIs, student interpreters, multilinguals, monolinguals	L1	✓		✓ ³	✓ ³
Signorelli <i>et al.</i> (2011)	PSIs, NIMs	L2		✓		✓
Tzou <i>et al.</i> (2011)	Student interpreters and NIMs	L1/L2		✓		✓

Table 1. Summary of the literature by Signorelli & Obler, 2014

among the performances exhibited by groups was attributed to the duration of training they had received up to that date. Other test used was the reading span test in which presentations were only visual and their task was to read the sentences aloud and remember the last word in those sentences and it is frequently used for working memory tests. Interpreter group in the study outperformed translation students and they outperformed non-interpreters in recalling longer reading spans, thus suggesting that better storage and processing skills associated with the WM depended on the amount of training. The listening span test was also like the reading span test but presentations were auditory instead of visual. In both tests, interpreters proved to have higher WM capacity when compared to other groups. The same study also used their experimental groups to conduct a series of word-list recall tasks to measure the articulation suppression and interpreter group seemed to recall more words than other groups namely the non-interpreters and novel interpreters.

Study by Chincotta and Underwood (1998) emphasized the concepts of articulatory interference by focusing on the importance of rehearsal and its prevention by concurrent articulation during simultaneous interpreting. It was also noted by Baddeley and Hitch (1974) that any entry to the working memory would always fade away if rehearsal is not possible. Based upon the assumption that professional interpreters would be less affected by concurrent articulation compared to trainees and non-interpreters, Chincotta and Underwood used digit-span test to see if this assumption was true but data did not provide any approval to this. Christoffels, de Groot and Kroll (2006) compared interpreters and highly proficient bilinguals such as foreign language teachers and students by making use of non-digit word stimuli. Participants were presented three to ten words one by one and then asked to remember them in the same order with the presentation. At the end, word spans achieved by each group were noted down and interpreter group was superior to the other two groups. The study also found that interpreters outperformed non-interpreters in a reading-span task where interpreters seemed to have better WM skills than students and teachers.

Another study by Köpke and Nespoulous (2006) focused again on articulation suppression and results supported those by Padilla (1995). It was again professional interpreters, student interpreters, bilingual and monolingual speakers being compared,

yet the study by Köpke and Nespoulus differed from that of Padilla in that the stimuli was auditory instead of print stimuli. In this free-recall task, participants were asked to repeat the syllable “*bla*” while hearing words but they were requested to recall these words at the end of the list as they wished, without trying to comply with the presentation order. Interestingly, student interpreters achieved the best performance in contrast to other studies and authors reported that novice interpreters were followed by experts and non-interpreters respectively.

Signorelli, Haarmann and Obler (Signorelli, 2012:95-125), on the other hand, found superior interpreter performance over non-interpreters in a non-word repetition task where words without meanings are used to observe the processing of speech-sound information as they have no semantic information embedded in them. Participants repeated 18 non-words ranging in the length of syllables they have. Results showed that interpreters outperformed non interpreters in non-word repetition and thus suggested that phonological working memories of interpreters were much better than those of non-interpreters.

The digit-span experiment by Tzou, Eslami, Chen and Vaid (2011) also showed superior performance by second-year interpreter students in a study where 20 student interpreters and 16 non-interpreter students were compared. This study together with Signorelli’s (2014) also supported that interpreters outperformed others in sentence-based reading span task by illustrating that first and second year students were better than non-interpreter graduate students.

Although these studies are not enough to put a concrete rationale forward, in both simple word-based and complex sentence-based tasks, there was a clear WM advantage of interpreters observed. Yet, there exist also studies suggesting that their results are evidence for no crucial difference of performance between interpreters and non-interpreters in terms of WM skills such as that of Liu Schallert and Carroll (2004). They also carried out a listening-span experiment with professional interpreters and student interpreters which were classified in two groups as advanced and beginner students. Participants listened to some sentences as sets and at the end of each set they were asked to write as many words from these sentences as they could recall and these words would define their phrase span. Notably, no significant difference was detected in the phrase

spans of groups as mean scores for each were very close to each other. However, even having no crucial differences the scores were again highest for professionals and advanced students followed them.

Morales et al. (2015) set out to explore the multiple task coordination in a single and dual n-back task (Jaeggi et al., 2008) in individuals with SI experience and controls consisting of people with no interpreting activity. The results pointed out that simultaneous interpreters exhibited better performance than did bilingual non-interpreters in n-back tasks. However, these findings do not prove that experience in SI yields improvement in the coordination of multiple tasks.

Following Morales et al.'s study (2015), a relatively recent study further approached the issue of multiple and concurrent information processing skills of simultaneous interpreters where the aim was to see if the experience in simultaneous interpretation could yield superior skills in coordination of multiple tasks and if this experience was anyhow related to dual task related higher-order executive functioning (Strobach et al., 2015). The results has pointed out that people with SI experience exhibited faster reactions times for dual tasks than the control group which was consisted of individuals with no experience of SI. Thus, Strobach et al. concluded that simultaneous interpreters could better coordinate the multiple tasks in lab-based dual task situations.

2.7. Dual N-Back Task

Dual N-Back task is a variation of the previously presented n-back task and it was proposed by Susanne Jaeggi (2003). The n-back task had first been introduced by Wayne Kirchner (1958) as a tool to measure a part of working memory in cognitive neuroscience (Gazzaniga, 2009) where the subject was presented a sequence of visual or auditory stimuli and asked to indicate whenever a stimuli matches the one n steps earlier in the continuous stream. In dual n-back task, both visual (boxes) and auditory (letters or numbers) stimuli sequences are presented simultaneously and there is relatively more stress on the subject as in this paradigm, s/he has to remember several items in memory and be able to update them swiftly (See Figure 10).

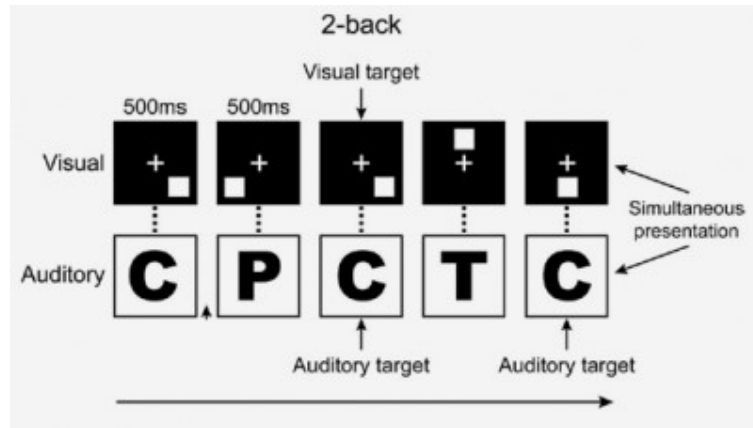

Figure 10. Standard Dual N-Back Task by IQMindware

As the aim of all working memory cognitive interventions is to expand WM capacity, the main intent of the dual n-back task is also push the limits of WM capacity and improve attentional control by making the subject maintain and update memory information in both the visual and verbal short-term stores of WM and this is called the standard dual n-back task. This cognitive training task is claimed to boost the activations in the regions normally known to take part in the tasks associated to WM. These regions were illustrated by Killenberg (2002) as lateral pre-frontal cortex and parietal cortex which are both part of the fronto-parietal axis (See Figure 11).

As previously mentioned in this study, working memory is linked to many higher-order cognitive skills as recent studies have revealed and people have been investigating ways to train their WMs in order to achieve better performance in every part of their daily lives and activities. According to data, actually, mind's "workspace" (Smith: 8) can be expanded with training and one of the most popular training methods in this field is the dual n-back task as it is the only brain training game which is proven to be valid by scientific studies. The fundamental barrier against maintaining a better WM capacity to this extent is the number of items – or "chunks" of information one can store in

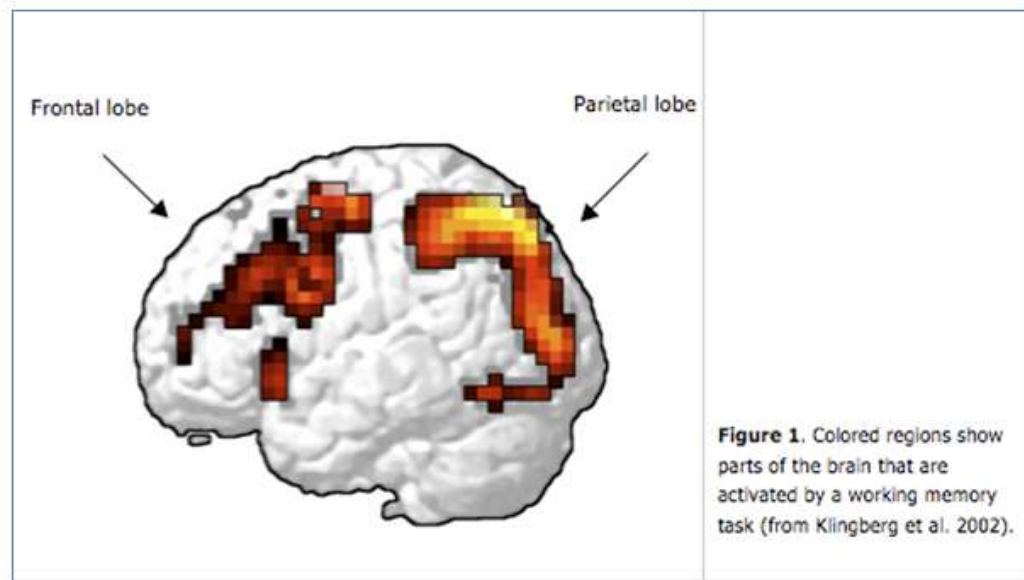

Figure 11. Cortical Areas of Working Memory by Killenberg (2002)

mind at one time for processing advanced cognitive functions and dual n-back task is used to achieve this with creating long-term neuroplasticity changes in the brain's neural networks underlying the abilities letting us perform complex cognitive functions.

The dual n-back task software applied in this study is developed and provided by Dr. Mark Ashton Smith who is a cognitive neuroscientist and currently conducting research in IQ interventions. In his review on “*How to Optimize Your Dual N-Back Training*” Smith indicates that it is the central executive that controls the flow on information into the verbal and visuo-spatial short-term stores and the inhibition of irrelevant information which helps us focus on the relevant information. This is also the systems enabling humans maintain the updated items in mind and eliminate interference when subjects are training with the dual n-back. When practiced regularly, the task seems to create an overload on the WM span and stimulate the *hormesis response* and the *upregulation of vitagenes* resulting in the neuroplasticity.

Traditional dual n-back training seemed to have some limitations such as small IQ gains as revealed by the last meta review (Jaeggi 2014) mentioned before in this study, due to the use of strategies, and low motivation which can all result in minimizing IQ gains. In

order to boost the neuroplasticity effects, the Dr. Smith and his colleagues developed an improved dual n-back version that eliminates the counterproductive strategies such as the attention jumping, rehearsal (only this strategy would not hamper the improvement of WM) and chunking problems experienced in Jaeggi's original dual n-back task which may result in the minimization of the benefits to be gained at the end.

Moreover, according to the explanations in the official website of "HighIQPro", WM games targeting core WM mechanisms must be designed to limit the use of some strategies (chunking, attentional hopping, playing with the odds), minimize automatization in order to avoid effortless practicing, must include stimuli from different modalities (visual and audial), must require doing a task when there is an interfering information, support rapid WM encoding and retrieval demands, adapt to the present levels of players as they advance and demand hard cognitive tasks requiring intense focus. As to the counter-productive strategies mentioned above, the task is claimed to prevent attentional chunking by providing letter and number options for the stimuli and also hampers attentional blinking as it presents an option for a "hard task setting" making the players unable to use strategies such as chunking and playing the odds with even more harder algorithms provided as they advance in the game and increase their n-back levels. Furthermore, as to the limitation of "motivation" which is required to complete the 20 day course to be able to obtain the benefits guaranteed, the HighIQPro dual n-back software provides some incentives to encourage the players such as the reward sounds and the top 10 table where users can compare their results with others.

The basic training period for the dual n-back game is 20 days 15-25 minutes a day and at the end of each day, you have a statistical progress feed-back option to help you see how much improvement you have achieved since your last trial and the training is claimed to result in permanent neuroplasticity changes (McNab, 2009) which is illustrated with neuroimaging studies carried out by researchers (See Figure 12) and long-term IQ gains (Lehrer, 2011). Experimental studies on medical subjects also reveal data suggesting that n-back task training also led to improvements in verbal learning

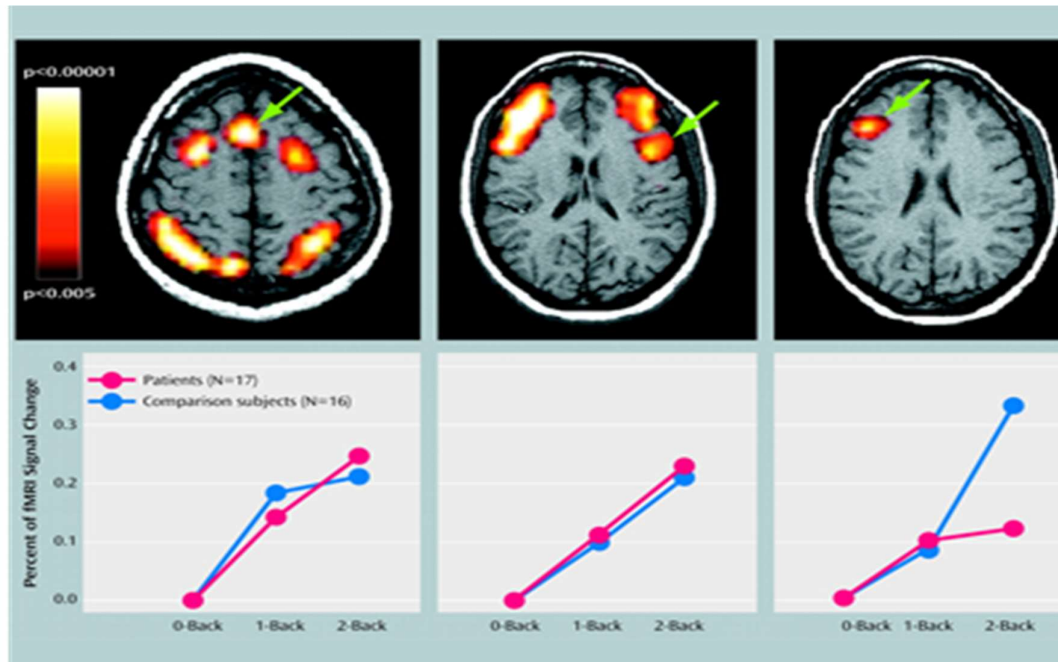

Figure 12. Neuroplasticity inducing training method by HighIQPro

(Klingberg et al., 2002) and everyday attention in people over 60s (Chein et al. 2011), reduced symptoms of ADHD (Thompson, 2013), and in everyday memory in MS (multiple sclerosis) (Klingberg et al. 2005) and schizophrenia patients (Lawlor-Savage, Goghari, 2014)

This study dwells on effects of the dual n-back task on the simultaneous interpreting performances of 3rd year interpreting students. Specific cognitive skills claimed to be improved by dual n-back training such as multi-tasking, detaching attention from irrelevant items and attending to new information, eliminating interference and verbal learning (Morrison & Chein, 2011; Salminen, Strobach & Schubert, 2012) are the core functional processes required for interpreting in simultaneous mode. Therefore it can be concluded that there are commonly shared neural networks for the improvement of both WM capacity and simultaneous interpretation, which leads to the conclusion that dual n-back task and simultaneous interpretation has something in common as illustrated in Figure 12b. Taking the promise holding results of studies conducted on the benefits of working memory trainings and its close relationship with cognitive tasks, this study

might be another brick for forming a practical approach towards the close relativity of simultaneous interpretation and working memory training.

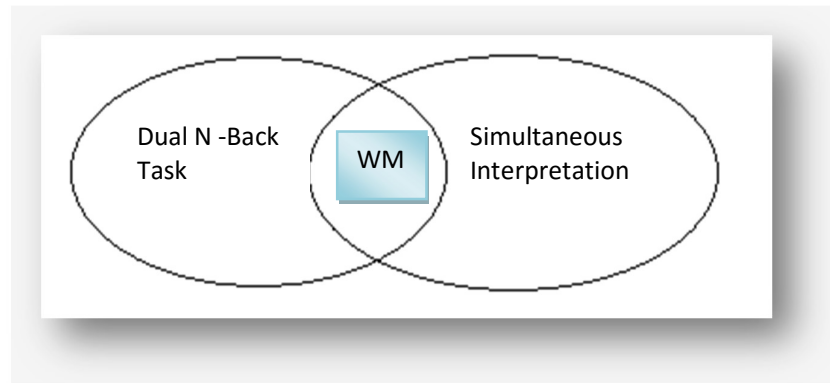

Figure 12b. WM as a common unit for Dual N-Back task and Simultaneous Interpretation

Next chapter will include the research design and methodology followed in this study with a detailed explanation of the processes involved in the experiment. Detailed information regarding the data collecting instruments and the data analysis methods will also be described.

CHAPTER 3

METHODOLOGY

This study was conducted in order to assess the possible effects of the dual n-back training on the general interpreting performances, especially from the perspective of working memory, of the 3rd year students studying at the Translation & Interpreting Department of Hacettepe University, Ankara. The four main purposes of the chapter is to (1) describe the research methodology and research design of this study, (2) explain the sample selection, (3) describe the procedure used in designing the instruments and collecting the data, and (4) provide an explanation of the statistical analysis procedures used to report and interpret the data gathered.

3.1. RESEARCH METHODOLOGY AND RESEARCH DESIGN

In this study, a descriptive research methodology is used due to the fact that the main objective of the study was to find whether the “dual n-back task” yields any improvement on the general interpreting performances of 3rd year students at the Department of Translation & Interpretation or not. The study was based on a “one group pre-test post-test design” (see Wang, Jue & Morgan, A. George: 1083-1085) to measure the magnitude of the change resulting from the intervention, which in this case was the dual n-back training task, by comparing the pre-intervention data to post-test intervention data. Therefore, it can be classified generally as a one group pre-test post-test design design where the subjects served as their own control and the effect of a variable was evaluated as shown above.

Group I	Intervention (2 months training)	Group I
Test SI I (O ₁)	Dual N-Back Task (X)	Test SI 2 (O ₂)

Table 2. One Group Pretest-Posttest Design

The group was observed once at the very beginning by a pre-test so as to figure out the baseline score before the training occurred. The main task expected from the students was to write down their personal interaction with the test as a commentary of their own ability to perform simultaneous interpretation in the booth. Eventually, a questionnaire was administered to the participants to obtain a final self-evaluation considering their ultimate view on their progress within this 2-month time and especially on the aspects they assumed to have achieved a better competence.

3.2. PARTICIPANTS- POPULATION AND SAMPLE

The participants of this study are 20 students at their 3rd year, taking Introduction to Interpreting course at the Department of Translation and Interpretation of Hacettepe University. Listening Comprehension and Oral Presentation, Note-taking for Consecutive Interpreting, Speaking Skill I and Speaking Skill II, Cultural Studies, Intercultural Communication are some of the courses which established their cognitive entry behaviours. The population of the study is 3rd year students studying at the Translation and Interpreting Departments in Turkey. The sample of the study consists of twenty 3rd year students studying at Hacettepe University, Translation and Interpretation Department. The decision of taking 3rd year students as a population and sample in this study was based on the fact that the students could only acquire the right of taking the Introduction to Interpreting Course as soon as they complete their first two academic years successfully. Only at this time point can a student be considered as “equipped” enough to sit in a booth after grasping the core theory and the basic skills needed to carry out the challenging act of interpreting.

3.3. PROCEDURE

This study was carried out to see if dual n-back training task yields any improvement in the simultaneous interpreting performances of the 3rd year students of the Department of Translation & Interpretation at Hacettepe University, Ankara. Of particular interest was

the impact of the 2-month dual n-back training on the ability of interpreting the lexical, numerical and episodic information embedded in the paragraphs from English (L2) into Turkish (L1 i.e. mother tongue), which requires efficient working memory capacity.

3.3.1. Preliminary Studies

Prior to the major research in depth, preliminary studies carried out included the following:

3.3.1.1. Selecting the samples

Third year students were selected as the participants of the study due to such main reasons as the availability of the adequate number of participants and the level of competence. Willingness of the participants to take part in this study was a significant factor as it always is in such researches carried out on human beings. Besides, in this study, pre- and post-tests were going to be administered at the weekends as the students already had other courses to attend throughout the week. Consequently, for statistical and practical purposes, 20 was decided to be the optimal number for the participants to be evaluated within the scope of this study. Additionally, for the purposes of this study, “one group pre-test post-test design” was determined to be the most appropriate one, depending not only on the previous similar research in the literature but also of the factors of practicality and availability.

3.3.1.2. Dual N-Back Training as a Course Material

The independent variable, the effects of which was to be observed and measured in this study is called the “dual n-back training” task and essentially, it is a computer game created to enhance the working memory capacity and thus the IQ levels of its permanent users. The creator of the neuroplasticity software “IQ Mindware”, which provided us the chance of benefitting from the independent research, experiments and development being carried out within this cloud, Dr. Mark Ashton Smith, is known to develop

braining training interventions together with other researchers to increase IQ, working memory, decision making, performance and executive functioning. Dr. Smith also hold the Lecturer/Assistant Professor position in the Department of Psychology of Bilkent University, Ankara. Therefore, as soon as the underlying bricks of this study was specified, a face to face meeting was hold with a lecturer in this Department by the advisor of the thesis, Prof. Dr. Aymil Doğan. The aim of this meeting was to get the contact information of Dr. Smith and any other information relevant. Consequently, a meeting with Dr. Smith was conducted by Prof. Dr. Doğan in London, which will be explained in detail below.

Additionally, literature review had been conducted regarding similar studies in Turkey. The only study including “n-back task” as a factor within was being conducted by Asiye Öztürk, the research assistant in Atılım University, Ankara. This study differed from our study essentially in the fact that the intervention applied in Öztürk’s study was not dual-task paradigm, but single n-back task using only visual stimuli. Phone calls were made with Öztürk in order to gain helpful information, at least on the aim, design and scope of Öztürk’s study.

Right after the meeting with Dr. Smith in London, the preparations for this application has been launched. Correspondence with Dr. Smith had been exchanged for a long period of time before the experiment on the students could be started in practice. Some certain aspects of the study regarding the dual n-back training task, such as the appropriate research design, number of participants and factors to be measured were consulted with the creator of the software, Dr. Ashton Smith. Literature review had been conducted at the same time Access to the dual n-back training software was acquired thanks to Dr. Ashton Smith via IQ Mindware Ltd. and the application was studied in depth to learn how the training works and how it can be used for students. Subsequently, a link for downloading the dual n-back software was provided to each participant of the study again by IQ Mindware Ltd and an introductory course was organised in the Library of Hacettepe University with the participants to make sure that all of the students are well aware of and informed about the experiment as well as the game itself.

3.3.1.3. Introduction to Dual N-Back Training

An introductory meeting was conducted on the 1st April 2015 in the Library of the Beytepe Campus, Hacettepe University in Ankara. All students took part in the meeting with their computers and the dual n-back training task was introduced to them in detail. Each and every student was first of all registered to the game by creating a personal profile so that their daily scores could be recorded in the database when the training period is started. A practice profile was also created for everyone to enable visual and auditory exercise modes. Both theory and practice were mentioned in this meeting and some exercise was also made following the introduction to guarantee that complete understanding of the game was obtained and all of the students were acquainted with the game.

The students were strictly warned not to make any changes on the initial default settings of the game at the central panel. However, they were advised to keep track of the “hall of fame” where the top 10 scores were listed, and also keep the “fanfare” sound effect on which were some of the applications developed by IQ Mindware Ltd. to encourage the users and boost the motivation of the players. This fanfare sound imitated a victory celebration after each n-level was successfully completed and access to a new level was reached. It was also recommended to use earphones while playing the game if they would help them completely and solely concentrate on the game (This information was acquired from the help page of the Brain Software by IQ Mindware). Since this meeting was made, participants had begun practising the game individually at home only in single stimulus mode until the pre-test was conducted which means they could only practice in the visual or auditory exercise mode of the game separately instead of playing it in dual visual-auditory mode. Although the real dual n-back game included 20 n-trials for 1 Block, the single stimulus modes was consisted of a 10 Block Session. With this practice, it was intended to make the game familiar for the participants until the intervention period of the experiment started.

3.3.1.5. Setting the schedule

A group called “Simultaneous Interpretation Study” was established on internet through social media as a communication tool where 7/24 contact with the participants could be obtained. This group was used as an ever-available environment where the time-table for the meetings with the students were organised. The date, time and place of the meetings at the Simultaneous Interpretation Laboratory were first announced through this group and a consensus was reached. Messages were also sent to the mobile phones of all the students to make sure that everyone had heard of the upcoming study. This procedure kept to be followed until the very end of the study.

3.3.1.6. Simultaneous Interpreting Study

Participants of the experiment carried out in this study were all 3rd year students and they were at the beginning of the spring semester. Therefore, they already had done some initial exercises for beginners such as memory training techniques, multi-tasking, background learnings from educational psychology and discourse analysis beginning from their first/autumn semester. They also took introductory courses for the development of ability for booth usage. This course covers the usage and management of the tools as well as the ability of controlling the physical and mental processes in the booth.

A complementary application to this course was the introduction of simultaneous interpreting as a profession and skill in which the most-widely used stereotype patterns found in international speeches were practiced such as “I would like to thank you all/extend my greetings...”, “The floor goes to ...”, “The assurance of my highest consideration...” and “Please accept my apologies/condolences...”. The mostly used terminology used during conference interpreting was also touched upon in addition to the stereotype patterns. Depending on this background information, the participants of the experiment kept on taking their routine interpreting courses throughout the study also during the spring semester.

3.3.1.7. Preparation of the Tests and Teaching Materials

Based upon the level of students, various paragraphs were prepared in order to be used as pre- and post-test materials. These paragraphs were generally composed of simple sentences with no complex syntactical structures and standard vocabulary. This deliberate choice stemmed from the fact that the main aim of the experiment was to measure the effects of a memory training task, dual n-back task, so any other factors that would possibly affect the performance of students during the tests such as complex syntax and unfamiliar or rarely used vocabulary were particularly eliminated to increase the validity of the study. Technical vocabulary and unnecessary information were avoided within the paragraphs. The subjects of the texts were picked up from general domains such as politics, communication, global warming, health problems, labour health and security, kitchen and food, internet, fashion, animals, popular events, travelling, earth and geography, natural disasters, literature, economy and domestic violence which can all be classified as daily mentioned, familiar issues.

The tests were composed of three parts, divided according to the qualifications subject to measurement. Pursuant thereto, the first part was to measure the ability of interpreting sequential events within a text, the second part to measure lexical items and the third and last part was to measure the ability of interpreting figures embedded in a passage. Therefore, any elements other than the main aspect subject to measurement under each chapter were particularly removed and the passages were formed for maximum simplicity and plainness, purified from complexity.

3.3.1.8. Vocabulary Lists and Questionnaire

A vocabulary list was prepared previous to the tests and distributed to the participants as a supporting document so that they may obtain assistance from this list if any unfamiliar word appears (See Annex 1). These passages were applied on a pilot group first by reading them out and checking the level of difficulty with the help of the feedbacks coming from the students. Additionally, a questionnaire was prepared and given to the participants after the post-test as a supplementary data collecting material to make an

assessment of the process carried out for 2 months. The questionnaire included multiple choice questions regarding the individual views and comments of the participants on the experiment and their own progress on simultaneous interpreting (See Annex 2). With the help of this questionnaire, the perspectives of the participants subordinate to the training could be gathered.

3.3.2. Experimental Study

3.3.2.1. Preliminary Test

Prior to conducting the pre-test to gather the initial results, a preliminary study was carried out to determine at what level of difficulty the texts should be formed. For this reason, an article was read out to the participants in the simultaneous interpretation laboratory of the Translation & Interpretation Department of Hacettepe University which can be found as “Annex 3” within this study. With the help of the assessment made during this preliminary study, it was determined at what level of difficulty the paragraphs should be constructed so as not to hinder the overall success of the students and cause any misleading in future measurements. By considering the success of each and every student in interpreting this article, a general outline was figured out for the preparation of the texts to be included in the pre-test and post-test.

3.3.2.2. Pre-test

The pre-test of this experiment carried out after the preliminary test consisted of 30 paragraphs in total. Before beginning the test, the general framework of the study was explained to the group of 20 participants to help them figure out what is actually expected from them and thus ensure the right conditions of a reliable experiment.

Eventually, each and every participant took their seats in individual sound proof booths with their headphones and microphones in the Simultaneous Interpretation Laboratory and the paragraphs were respectively read out. The reading rate was always kept

consistent in such a way that it would neither be too fast nor too slow, and rather like the rate of the speeches they were supposed to interpret during the usual interpreting courses they have been taking. While the students were interpreting the passages one by one, their voices were recorded at the main computer's database of the laboratory for later investigation. After each part of the test was completed, two sample passages were read out likewise before the real test started in order to emphasize the main aim of each chapter. Accordingly, students try to accomplish each chapter by trying to recall all the events, lexical items and figures respectively and also interpreting them in the right sense. Please see Annex 4 for the pre-test passages.

3.3.2.3. Dual N-Back Task- Training

Training in this study refers to the daily practice of the dual n-back game already downloaded on the personal computers of students. They were requested to play the game for minimum 20 minutes every day for 5 days a week, with only two days off per week. This 20-minute time period was the time required to complete "1 Block" which means 20 times N-Trials. In contrast to the single n-back task, participants are required to recall two different streams of stimuli; a visual one and an auditory one. In the Dual N-Back Software for Desktop, there are 9 spatial positions for the visual modality and 9 letter positions for the auditory stimuli and participants are required to press a key (F) whenever the currently presented square is at the same position as the one n stimuli back in the series, and another key whenever the presented letters (L) matched the one that was presented n stimuli back in the sequence. The time interval between presenting stimuli was 3 seconds. A visual illustration of the task is provided below (See Illustration 1).

The key features of the dual n-back task were the requirements of 1) updating the WM when new stimuli enters, 2) dual task coordination, 3) task-switching and 4) an efficient attentional control. Targets could occur in one modality stream or in dual modality streams. Every time the participants completed a level with at least a success rate of 90%, they automatically got access to the next level. If any score under this percentage was acquired, the game directed the user to the previous n-back level. Briefly, the more

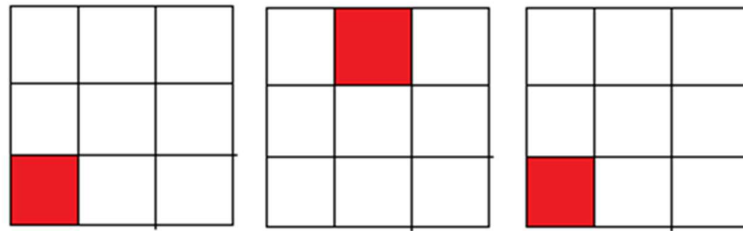

Illustration 1. An illustration of the visual 2 n-back

practice a user made on the game, the higher levels s/he could reach. As mentioned before, the default settings of the dual n-back game remained the same as it was initially fixed, no change was made on the conditions of the game to ensure that all of the participants were subject the same rules, conditions and level of difficulty.

The date of the pre-test was 05th.04.2015 and the training was also started on the same day. The participants were requested to begin playing the game in dual mode with profiles named after their real names and surnames which would make it easier to closely follow their performances. The decision of playing the game either in two sessions by dividing the work into two equal parts, in other words in 10/10 sessions or simply completing 1 Block (20 N-Trials) at one sitting was left up to their own appreciation. It was also underlined that in case of choosing the 10/10 sessions option, they should split the work into two equal parts as 15 minutes in the morning and another 15 minutes in the afternoon. It was additionally noted that choosing to complete 20 sessions at one sitting would be much more desirable and that once this decision is made, it would be impossible to change it afterwards. Under these circumstances, the training period for students began on 4th April 2015 and lasted until the day the post-test was conducted, which was on 31st May 2015.

3.3.2.4. Post-test

Post-test was carried out 60 days (2 months) after the pre-test was conducted. The structure of the test was exactly the same with regards to the number of passages read

out and the sequence of the sections. First came the interpretation of the sequential events part and it was followed by the lexical items whereas the last part of the test was the interpretation of the figural items. Like the procedure followed in the pre-test, a vocabulary list was distributed to the students so that any unfamiliar words or unknown terminology would not distract their attention and affect the results negatively. The test lasted for approximately 30 minutes like the pre-test and the voices of the students were recorded at the main computer's database via microphones they were talking into. A multiple choice questionnaire was distributed in pursuant to the test and it was requested from the students to evaluate themselves. The aim of the questions was to directly or indirectly evaluate the difference the training was supposed to generate on their interpreting performance. The questionnaire included 15 close-ended questions and the general framework was to see if there is any change in their views on their self-sufficiency and comments on the training. Please see Annex 5 for the post-test passages.

3.3.3. Data Collecting Instruments

In this study, various testing instruments were utilized to collect data for the experimental process carried out such as tests comprised of passages to be recalled and interpreted, a questionnaire and dual n-back training software. Each of these data collecting instruments are described in detail below.

3.3.3.1. Materials for Simultaneous Interpreting

3.3.3.1.1. Pre-test and Post-test

In this study, a pre-test and post-test was used based on a “one group pre-test post-test design” to measure the degree of effect that WM training – through dual n-back task-yields on the simultaneous interpretation performances of 3rd year students. Within this framework, a pre-test and post-test were administered to the participants within a 2-month interval of training period. The pre-test and post-test were both consisted of 30 passages in total, divided into three chapters as “passages for lexical items”, “passages for sequential events” and “passages for figures” where each chapter targeted a specific aspect of the speeches interpreters generally work on. The same text was used for both

the pre-test and post-test- except for the small differences made on the vocabulary and the flow of sentences. Speech rate was constant and it was always maintained at the same level throughout the 2-month process also for the exercises done in the “Introduction to Simultaneous Interpretation Course”, which were being carried out simultaneously during the study.

Validity

Both tests were examined and confirmed by two experts who are both conference interpreters and trainer of simultaneous interpreters at the Department of Translation & Interpretation. Therefore, “expert opinion” was acquired to provide the “content validity” of the passages prepared for the tests.

Reliability - Internal Consistency

The internal consistency showing the reliability of the test questions, which in this case were the missing items embedded within the passages, was calculated with the Kuder & Richardson 20 Formula as the items were noted on a binary scale where the answer of the questions were either correct or incorrect. Accordingly, a correct reply scores 1 while an incorrect reply scores 0. The test statistic is;

$$\rho_{KR20} = \frac{k}{k-1} \left(1 - \frac{\sum_{j=1}^k p_j q_j}{\sigma^2} \right)$$

where,

- ρ_{KR20} is the Kuder-Richardson formula 20,
- k is the total number of test items,
- Σ indicates to sum,
- p is the proportion of the test takers who pass an item

- q is the proportion of test takers who fail an item
- σ^2 is the variation of the entire test

The calculations made are illustrated in Table 3 and Table 4 below. According to the results, it can be concluded the pre-test has a “high internal consistency reliability” where “KR-20= 0.762253” and where “reliability coefficient $> .70$ ”, which is the limit value for a test to be considered as internally reliable in psychology (Büyüköztürk: 182-183). The same calculations were also made for the post-test scores to evaluate the overall consistency of the post-test. The data led to the conclusion that the internal availability of the post-test is also highly reliable where $KR-20 = 0.674809$. As the tests used in this study were prepared as training materials to be used in the classroom, the limit value for the level of internal reliability can be considered “ $>60 -70$ ”, so the post-test can also be assessed as adequate in terms of reliability.

	p1	p2	p3	p4	p5	p6	p7	p8	p9	p10	p11	p12	p13	p14	p15	p16	p17	p18	p19	p20	p21	p22	p23	p24	p25	p26	p27	p28	p29	p30				
Selma	0	1	0	0	1	1	1	1	0	1	1	1	1	1	1	0	0	1	0	1	0	0	0	1	0	0	1	0	0	1	16			
Esra	0	0	0	0	1	1	0	0	0	1	1	1	1	1	1	1	0	1	0	0	0	0	0	1	1	0	0	0	0	1	13			
KÜora	0	0	0	0	1	0	0	0	0	1	0	0	1	0	0	1	0	0	0	0	0	0	0	0	1	0	0	0	1	1	7			
Beyza	0	0	0	1	1	1	0	1	0	1	1	1	1	1	0	1	1	1	0	1	0	0	0	0	0	0	1	0	0	0	14			
Amina	0	0	1	0	0	0	1	1	0	0	0	0	0	1	0	0	0	0	0	0	0	0	0	0	0	1	0	0	0	0	1	6		
Gizem	1	1	0	0	0	0	1	0	1	1	0	0	1	1	0	1	0	1	1	1	1	0	0	0	1	0	0	1	0	0	1	14		
Nazlı	0	0	0	0	0	1	1	1	1	1	1	1	1	1	1	0	0	1	0	0	0	0	0	1	1	1	0	1	1	0	1	17		
Şüheda	0	0	0	0	0	0	0	0	0	1	0	0	0	1	1	1	0	1	0	0	0	0	0	0	1	1	0	0	0	0	1	8		
Buğra	0	1	1	1	1	1	1	1	1	1	0	1	1	1	1	1	0	0	0	1	0	0	1	1	1	1	0	1	0	0	1	20		
Kader	0	1	0	1	1	1	0	1	1	1	0	0	1	1	0	0	0	1	0	1	0	0	0	0	1	1	1	1	0	0	0	15		
Mehmet	0	1	0	0	0	0	0	1	0	1	0	1	1	1	0	0	0	1	0	0	0	0	0	0	1	1	0	0	0	0	1	10		
Nihal	0	0	1	0	0	0	1	1	0	0	0	1	0	1	0	0	0	0	0	0	1	0	0	0	0	1	0	0	0	0	1	8		
Gökçe	0	0	1	0	1	1	0	0	0	1	0	1	0	1	1	0	0	1	0	1	0	0	0	0	0	1	0	0	0	0	1	11		
İlgaz	1	0	1	0	1	0	1	0	1	1	1	1	1	1	1	1	1	0	0	1	0	0	0	0	0	0	0	0	0	0	1	15		
Özgür	0	0	0	0	0	1	1	1	0	1	1	1	1	1	1	1	0	1	1	1	1	1	0	1	1	1	0	0	1	0	0	18		
Sıla	1	0	1	0	1	0	0	0	0	1	0	1	0	0	1	1	0	1	0	0	0	0	0	1	0	0	0	0	0	0	1	10		
Şilan	0	1	0	0	1	0	0	0	0	1	1	0	0	1	0	1	0	0	0	0	1	0	0	1	1	1	0	1	0	0	1	12		
Berk	0	1	1	1	1	0	1	1	1	1	1	1	1	1	1	1	1	1	0	1	0	0	0	0	1	0	0	0	1	1	20			
Nisa	0	0	0	0	1	0	1	0	0	1	0	0	1	1	0	0	0	1	0	0	0	0	0	0	0	1	0	1	0	0	1	9		
Aysun	0	0	0	0	0	0	1	0	0	0	1	0	1	0	0	0	0	0	0	0	1	0	0	0	1	0	0	0	0	0	0	5		
p	0,150	0,350	0,350	0,200	0,600	0,400	0,550	0,500	0,300	0,850	0,450	0,600	0,700	0,850	0,500	0,550	0,150	0,650	0,100	0,600	0,050	0,000	0,250	0,550	0,700	0,050	0,400	0,100	0,100	0,800	var	20,46316		
$p*q$	0,128	0,228	0,228	0,160	0,240	0,240	0,248	0,250	0,210	0,128	0,248	0,240	0,210	0,128	0,250	0,248	0,128	0,228	0,090	0,240	0,048	0,000	0,188	0,248	0,210	0,048	0,240	0,090	0,090	0,160				
																																	kr-20	0,762253

Table 3. Kuder & Richardson Formula 20 for the Internal Consistency of Pre-test Questions

	p1	p2	p3	p4	p5	p6	p7	p8	p9	p10	p11	p12	p13	p14	p15	p16	p17	p18	p19	p20	p21	p22	p23	p24	p25	p26	p27	p28	p29	p30		
Selma	1	1	1	1	1	1	1	1	1	1	1	1	1	1	0	1	1	1	1	1	1	1	0	1	0	0	0	0	0	1	23	
Esra	1	1	1	1	1	1	0	1	1	1	0	0	1	0	1	1	0	1	0	1	0	0	0	1	1	1	1	0	1	0	19	
KÜbra	1	1	1	1	1	1	1	1	1	1	1	1	1	1	0	0	1	1	1	1	1	0	0	0	0	1	0	0	0	1	20	
Beyza	1	1	0	1	1	0	1	1	1	1	1	1	1	1	0	1	0	1	1	1	0	0	1	0	1	0	0	0	0	1	19	
Amina	0	0	0	1	1	0	1	0	0	1	1	0	1	0	0	0	0	0	1	0	1	0	1	0	1	0	0	1	0	0	11	
Gizem	1	1	0	0	1	1	1	1	0	0	0	1	1	1	0	0	1	0	1	1	0	0	0	0	1	0	1	0	0	1	15	
Nazlı	1	1	1	1	1	1	0	1	1	1	0	1	1	0	1	0	1	1	1	1	1	0	0	1	1	1	1	1	0	1	23	
Şüheda	0	1	1	0	1	1	1	0	0	1	1	1	0	1	1	0	1	1	0	1	1	0	0	0	1	0	0	0	0	1	16	
Buğra	1	1	1	1	1	1	1	1	1	1	1	1	1	1	1	0	0	1	1	1	1	0	0	1	1	1	0	0	0	1	22	
Kader	1	1	1	1	1	1	1	0	1	1	1	1	1	1	1	0	1	1	1	1	0	0	1	0	1	0	1	1	1	1	24	
Mehmet	1	1	1	0	1	1	0	1	1	1	1	1	1	1	1	0	0	1	1	1	0	0	1	1	1	1	0	1	0	1	21	
Nihal	0	0	1	0	1	1	0	1	1	1	1	1	1	1	1	0	0	1	1	1	0	0	0	0	1	0	0	0	0	1	16	
Gökçe	0	1	0	1	1	1	0	1	1	1	1	1	1	1	1	0	0	1	1	1	0	0	1	1	1	0	0	0	0	1	19	
İlgaz	1	1	0	1	1	1	1	1	1	1	0	1	1	1	1	1	1	1	1	1	0	1	0	1	1	0	0	1	0	1	23	
Özgür	1	1	0	1	1	1	1	1	1	1	1	1	1	1	0	0	1	1	1	1	0	0	1	0	1	0	0	1	0	1	21	
Sıla	1	1	1	0	1	1	1	1	1	1	1	1	1	1	0	1	1	1	1	1	1	0	1	1	1	1	1	1	0	1	26	
Şilan	1	0	0	0	1	1	1	0	1	1	1	1	1	1	0	0	1	1	1	1	0	0	1	1	1	0	1	0	0	1	19	
Berk	1	1	1	0	1	1	1	1	1	1	1	1	1	1	1	1	1	1	1	1	0	1	1	0	1	0	0	0	0	1	23	
Nisa	1	0	1	1	1	1	1	1	1	1	1	1	1	1	1	0	1	1	1	0	1	0	0	1	1	0	0	1	1	22		
Aysun	0	1	1	1	0	1	1	1	1	1	1	1	1	1	0	0	1	1	1	1	0	0	0	0	1	0	0	0	0	1	18	
p	0,750	0,800	0,650	0,650	0,950	0,900	0,750	0,900	0,750	0,950	0,800	0,900	0,950	0,850	0,550	0,300	0,650	0,900	0,850	0,950	0,200	0,150	0,600	0,450	0,950	0,200	0,350	0,300	0,150	0,900	var	12,84211
p*q	0,188	0,160	0,228	0,228	0,048	0,090	0,188	0,090	0,188	0,048	0,160	0,090	0,048	0,128	0,248	0,210	0,228	0,090	0,128	0,048	0,160	0,128	0,240	0,248	0,160	0,228	0,210	0,128	0,090			
																															kr-20	0,674809

Table 4. Kuder Richardson Formula 20 for Internal Consistency of Post-test Questions

3.3.3.2. Instrument for WM training – Dual N-Back task

The aim of this study was to investigate the effects of the working memory training on the simultaneous interpreting performances of 3rd year interpretation students. The working memory training used as a data collecting instrument was called the “dual n-back task” and the version of the dual n-back exercise administered to the participants as a training in this study was the “N-Back Desktop Software” provided by the IQ Mindware Ltd. 20 Participants exercised the Dual N-Back (N-Geri) training for 2 months, 5 days a week for 20 minutes. Eventually, the dual n-back levels of the participants were correlated with their ultimate SI test scores to see the degree of the impact the WM training is claimed to generate.

Known Benefits and Limitations of the N-Back Task

There exist many papers written on the effectiveness of the dual n-back training on expanding the working memory capacity as well as improving some specific cognitive

functions underlying its components. Lillienthal et al. (2013), suggested that dual n-back training increases the capacity of the focus of attention while in a study where participants were trained on dual n-back task, Salminen, Strobach & Schubert (2012) reported that complex WM training can generate transfer effects on executive functions and encouraged future studies to clarify the specific effects of WM training. Other studies have illustrated that WM capacity may determine other cognitive skills such as simple attentional tasks (Kane et al., 2001; Bleckley et al., 2003; Fukuda and Vogel, 2009), reading comprehension (Daneman and Carpenter, 1980, Chein and Morrison, 2010), reasoning and problem-solving (Kyllonen and Christal, 1990; Engle et al., 1991; Fry and Hale, 1996; Barrouillet and Lecas, 1999; Engle et al., 1999), along with executive functioning in everyday life (Kane et al., 2007), cognitive control (Klingberg et al., 2002, 2005; Westerberg and Klingberg, 2007; Chein and Morrison, 2010), fluid intelligence (Gf) (Klingberg et al., 2002; Olesen et al., 2004; Jaeggi et al., 2008), episodic memory (Dahlin et al., 2008a; Schmiedek et al., 2010; Richmond et al., 2011).

Furthermore, WM training is claimed to be also beneficial for different categories such as young adults (Klingberg et al., 2002; Dahlin et al., 2008a; Jaeggi et al., 2008, 2010; Chein and Morrison, 2010), and older adults (Schmiedek et al., 2010; Richmond et al., 2011) in terms of verbal learning and everyday attention, as well as for the treatment of some diseases, for example frontal lobe stroke (Westerberg et al., 2007), WM deficits (Holmes et al., 2009), and attention deficit/hyperactivity disorder (ADHD) in children (Klingberg et al., 2002, 2005; Holmes et al., 2010).

Obviously, WM training seemed to result in some neuroplasticity changes such as dorsolateral prefrontal cortex and posterior parietal cortex (Smith & Jonides, 1998; Wager & Smith, 2003) which relate to central executive functions. In his review on “*Neuroplasticity Mechanisms of Working Memory Training Transfer: How Brain Training Works*”, Smith (2015) emphasizes that the WM training targets the fronto-parietal (allows novel task control and goal maintenance) and dorsal attention network which underlies Gf and selective attention, and the transfer occurs also in other network levels because WM (updating tasks), attention control and Gf depend on shared executive control networks. He provides evidence from different studies that the WM

training may result in neurotransmitter efficiency (McNab et al., 2009; Tan et al., 2013) and increased grey matter volume (Takeuchi et al., 2013).

In another paper entitled “*Review of 2014-2015 Meta-Analyses on Working Memory Training for IQ and Working Memory*” (2015) Smith touches upon the benefits of WM training in terms of attention control, anxiety and depression. In a table referring to a meta-analysis of the WM training literature (Schwaighofer et al. 2015), he illustrates the significant near and far transfer effects of WM training such as on verbal STM (short-term memory) and LTM (long-term memory), verbal WM, and Visuospatial WM where the researchers had concluded that the more training resulted in greater gains and that age was not relevant to these gains. Another meta-analysis Smith mentioned in his review was conducted by Karbach & Verhaegen (2014) where the effects of WM and executive control training in younger and older adults were examined. The study provided positive results showing considerable effect sizes on attention control, fluid intelligence, episodic memory, STM and LTM, and processing speed. In this study, Karbach & Verhaegen estimated a 5.5 point IQ gain and this conclusion was supported by another meta-analysis carried out by Au et al. (2015) on WM training and fluid intelligence, where the researchers concluded that the training results in real IQ increases and there is no convincing evidence that WM training is in fact not effective.

Limitations regarding the WM Training

A comprehensive understanding of the characteristics of cognitive functions that may benefit from WM training still causes scepticism although there is a large amount of training literature, because of some issues related to the adequacy of the control groups (Shipstead et al., 2012), the appropriate analysis of near and far transfer effects (Melby-Lervåg and Hulme, 2013) and how to control for task-specific learning (Redick et al., 2013). According to Smith (2015, *Review of Working Memory Training*), one of the limitations that might affect the consistency of results is the multi-modal information processing, which refers to the combination of various senses at the same time to process the received information. The multi-modal information processing is carried out in the “episodic buffer” which is a subcomponent of the “central executive” in

Baddeley's WM model while Jaeggi's traditional dual n-back task doesn't require such information-binding and leads to the conclusion that there is less attentional demand on the central executive. The second limitation addresses to the link between WM capacity and the ability to inhibit distractors. It is the interference control that the WM capacity and fluid intelligence shares in common, yet traditional dual n-back task requires no active inhibition of distracting information. Moreover, traditional dual n-back task seems not to generate any transfer effect on task switching or multi-tasking, and the reason might be that the task does not involve task switching like the lack of inhibition of distractors. The last point to mention is the motivation of participants. It is widely known that the performance of participants in a study also depend on their motivation and one of the biggest problems that the dual n-back programmes developed on the market is the lack of success in keeping the participants motivated until the end.

Any of these problems may have impacts on the results of the studies conducted on WM training and its near and far transfer effects. Therefore, researchers should be working on how to eliminate such concerns for the future of studies on WM training.

3.3.3.3. Questionnaire

A multiple choice questionnaire consisting of 15 close-ended questions was administered to the participants at the end of the post-test. The questionnaire was used as a supporting qualitative material just to support the quantitative results provided by the statistical analyses.

3.3.4. Data Analysis Methods

Data analysis techniques were considered to be the Kuder & Richardson Formula 20 for the reliability evaluation of the pre-test and post-test and to evaluate the difficulty level of each question included in these tests. Additionally, Wilcoxon signed ranks test was applied to find out if the hypothesis in this study can be claimed and see the degree of the impact of the WM training on the simultaneous interpretation (SI) performances of

students. Moreover, Spearman & Brown Rank Order Correlation Coefficient was calculated to find out the correlation between the dual n-back levels (in this case the training scores) and SI performance post-test scores of the participants. These steps were followed through IBM SPSS Statistics 23.0.

The analysis carried out for each question handled in this study as a research question will be provided with the initial results in the next chapter. Statistical tests made for the initial evaluation of the pre-test and post-test scores and an illustration of the data revealed by the questionnaire will also be provided.

CHAPTER 4

RESULTS

This chapter dwells on the outcomes of the data analyses carried out through some specific statistical tests. The results of the tests will be presented roughly to be reviewed in detail in the following chapters. Different tests are carried out for different aspects to be measured in line with the research question and subquestions and each test administered for each question are listed below with the initial results and some visual data illustrating the outcomes.

4.1. WILCOXON SIGNED-RANKS TEST

A Wilcoxon signed-ranks test was conducted on IBM SPSS Statistics 23.0 to see if there is a significant difference between the pre-test and post-test results of the participants in terms of their simultaneous interpretation skills. The test was carried out under three titles separately to see the difference between the pre-test and post-test SI interpreting performance scores of participants in terms of 1) sequential events, 2) lexical items, and 3) figures. Within this framework the results of the analysis on each part of the tests were indicated respectively in the tables below.

a. Sequential Events

The table below illustrates the results revealed by the IBM Statistics 23.0 for the Wilcoxon signed-ranks test regarding the significance of the scores in pre and post-test for the interpretation of sequential events.

NPar Tests (Non-parametric tests)

Descriptive Statistics					
	N	Mean	Std. Deviation	Minimum	Maximum
Sequential_pre	20	42,5000	21,49051	10,00	90,00
Sequential_post	20	80,5000	16,69384	40,00	100,00

Wilcoxon Signed Ranks Test

		Ranks		
		N	Mean Rank	Sum of Ranks
sequential_post - sequential_pre	Negative Ranks	1 ^a	4,00	4,00
	Positive Ranks	18 ^b	10,33	186,00
	Ties	1 ^c		
	Total	20		

a. sequential_post < sequential_pre

b. sequential_post > sequential_pre

c. sequential_post = sequential_pre

Test Statistics^a

	sequential_post - sequential_pre
Z	-3,674 ^b
Asymp. Sig. (2-tailed)	,000

a. Wilcoxon Signed Ranks Test

b. Based on negative ranks.

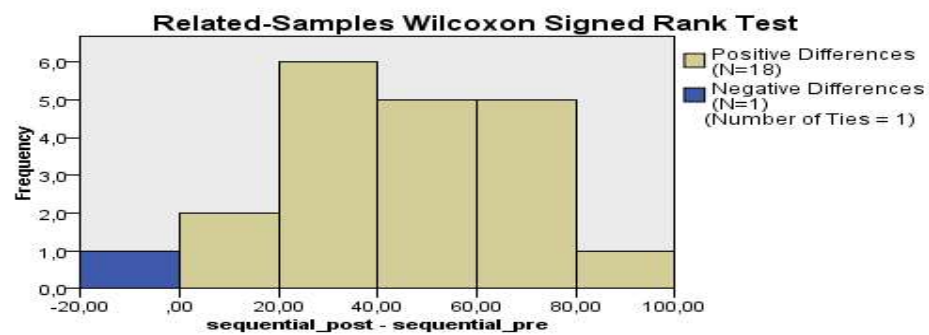

Total N	20
Test Statistic	186,000
Standard Error	24,771
Standardized Test Statistic	3,674
Asymptotic Sig. (2-sided test)	,000

Nonparametric Tests

Hypothesis Test Summary

	Null Hypothesis	Test	Sig.	Decision
1	The median of differences between sequential_pre and sequential_post equals 0.	Related-Samples Wilcoxon Signed Rank Test	.000	Reject the null hypothesis.

Asymptotic significances are displayed. The significance level is .05.

Result: A Wilcoxon signed-ranks test indicated that the pre-test scores of the participants for the SI of sequential events was statistically significantly higher than the post-test scores of the participants for the SI of sequential events, where $z = -3,674$, $p < .05$.

b. Lexical Items

The table below illustrates the results revealed by the IBM Statistics 23.0 for the Wilcoxon signed-ranks test regarding the significance of the scores in pre and post-test for the interpretation of lexical items.

NPar Tests (Non-parametric tests)

Descriptive Statistics

	N	Mean	Std. Deviation	Minimum	Maximum
lexical_pre	20	51,5000	23,23224	10,00	90,00
lexical_post	20	77,0000	15,59352	30,00	100,00

Wilcoxon Signed Ranks Test

Ranks

		N	Mean Rank	Sum of Ranks
lexical_post - lexical_pre	Negative Ranks	2 ^a	4,50	9,00
	Positive Ranks	16 ^b	10,13	162,00
	Ties	2 ^c		
	Total	20		

a. lexical_post < lexical_pre

b. lexical_post > lexical_pre

c. lexical_post = lexical_pre

	lexical_post - lexical_pre
Z	-3,348 ^b
Asymp. Sig. (2-tailed)	,001

a. Wilcoxon Signed Ranks Test

b. Based on negative ranks.

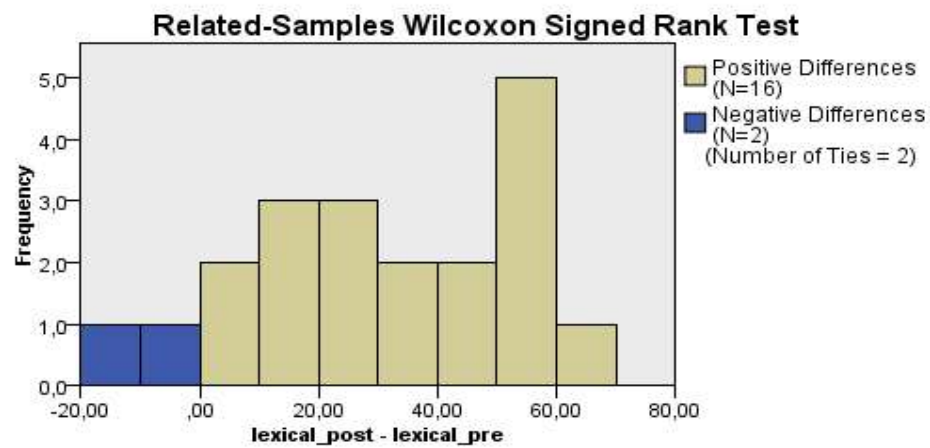

Total N	20
Test Statistic	162,000
Standard Error	22,847
Standardized Test Statistic	3,348
Asymptotic Sig. (2-sided test)	,001

Hypothesis Test Summary

	Null Hypothesis	Test	Sig.	Decision
1	The median of differences between lexical_pre and lexical_post equals 0.	Related-Samples Wilcoxon Signed Rank Test	,001	Reject the null hypothesis.

Asymptotic significances are displayed. The significance level is ,05.

Result: A Wilcoxon signed-ranks test indicated that the pre-test scores of the participants for the SI of lexical items was statistically significantly higher than the post-test scores of the participants for the SI of lexical items, where $z = -3,348$, $p < .05$.

c. Figures

The table below illustrates the results revealed by the IBM Statistics 23.0 for the Wilcoxon signed-ranks test regarding the significance of the scores in pre and post-test for the interpretation of figures.

NPar Tests

Descriptive Statistics

	N	Mean	Std. Deviation	Minimum	Maximum
figures_pre	20	30,0000	14,14214	10,00	60,00
figures_post	20	44,5000	15,38112	20,00	80,00

Wilcoxon Signed Ranks Test

Ranks

		N	Mean Rank	Sum of Ranks
figures_post - figures_pre	Negative Ranks	2 ^a	3,50	7,00
	Positive Ranks	14 ^b	9,21	129,00
	Ties	4 ^c		
	Total	20		

- a. figures_post < figures_pre
- b. figures_post > figures_pre
- c. figures_post = figures_pre

Test Statistics^a

	figures_post - figures_pre
Z	-3,203 ^b
Asymp. Sig. (2-tailed)	,001

a. Wilcoxon Signed Ranks Test

b. Based on negative ranks.

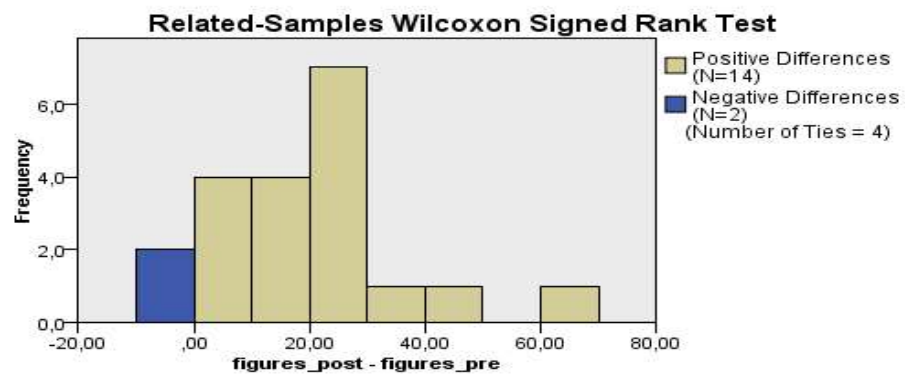

Total N	20
Test Statistic	129,000
Standard Error	19,043
Standardized Test Statistic	3,203
Asymptotic Sig. (2-sided test)	,001

Hypothesis Test Summary

	Null Hypothesis	Test	Sig.	Decision
1	The median of differences between figures_pre and figures_post equals 0.	Related-Samples Wilcoxon Signed Rank Test	.001	Reject the null hypothesis.

Asymptotic significances are displayed. The significance level is .05.

Result: A Wilcoxon signed-ranks test indicated that the pre-test scores of the participants for the SI of sequential events was statistically significantly higher than the post-test scores of the participants for the SI of figures, where $z = -3.203$, $p < .05$.

4.2. SPEARMAN BROWN RANK ORDER CORRELATION

Spearman & Brown Rank Order Correlation Coefficient was calculated for each variable to find out the correlation between the dual n-back levels (in this case, the training scores) and SI performance scores of the participants. The aim was to see if there is any positive correlation between the dual n-back level and the post-test scores of each participant on each variable measured. The calculations and results are indicated in Table 5.

A Spearman's rank-order correlation was run to determine the relationship between 20 students' dual n-back levels (scores) and SI performance post-test scores. According to the results;

- a) There was a weak but positive correlation between the dual n-back levels (scores) of the participants and their SI performance post-test scores on sequential events which was statistically insignificant ($r_s(20) = .305$, $p = .192$).

Nonparametric Correlations

			Correlations			
			sequential post	lexical post	figures post	dual n back level
Spearman's rho	sequential_post	Correlation Coefficient	1.000	-.235	.374	.305
		Sig. (2-tailed)	.	.319	.105	.192
		N	20	20	20	20
	lexical_post	Correlation Coefficient	-.235	1.000	.220	.040
		Sig. (2-tailed)	.319	.	.352	.867
		N	20	20	20	20
	figures_post	Correlation Coefficient	.374	.220	1.000	.758**
		Sig. (2-tailed)	.105	.352	.	.000
		N	20	20	20	20
dual_n_back_level	Correlation Coefficient	.305	.040	.758**	1.000	
	Sig. (2-tailed)	.192	.867	.000	.	
	N	20	20	20	20	

** . Correlation is significant at the 0.01 level (2-tailed).

Table 5. Spearman Brown Rank Order Correlation between the dual n-back levels and post-test scores of 20 participants illustrating the level of the significance between the dual n-back levels and post-test scores of the participants.

- b) There was a very weak but positive correlation between the dual n-back levels (scores) of the participants and their SI performance post-test scores on lexical items which was statistically insignificant ($r_s(20) = .040, p = .867$).
- c) There was a strong positive correlation between the dual n-back levels (scores) of the participants and their SI performance post-test scores on figures which was statistically significant ($r_s(20) = .758, p = .000$).

4.3. QUESTIONNAIRE

A questionnaire was administered to the participants subsequent to the post-test as an instrument to support the results provided by the Kuder & Richardson 20 Formula. The questionnaire consisted of 15 multiple choice questions where the participants could response as a) Yes (I agree), b) No idea or c) No (I don't agree). The results were calculated as percentages to illustrate the number of participants respondings as a, b, or c to each questions. The outputs are illustrated in the graph below. (See Graph 1)

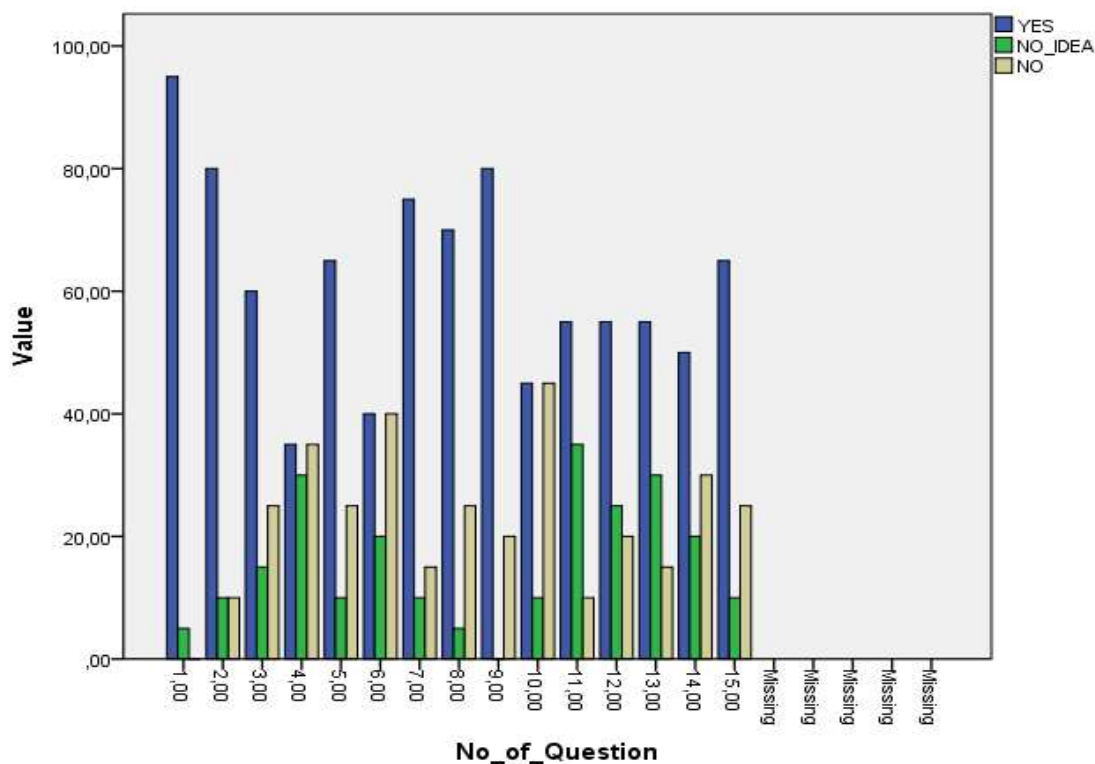

Graph 1. A bar chart showing the outputs of the questionnaire

Preliminary data suggested that the results of the KR Formula 20 and the data provided by the graph closely relate to each other positively in terms of the difficulty level of questions and the success rate of the participants. A detailed assessment on the overall data is to be made in next chapter.

CHAPTER 5

DISCUSSION

This chapter dwells on the detailed interpretation of the initial results gathered through the tests carried out. The outcomes will be handled within the framework of the aim and scope of this study as well as the prominence of the contributions provided with the results. The research question and subquestions will be answered in terms of the collected data and suggestions will be indicated subsequently.

5.1. OVERALL VIEW TO THE RESULTS

In the light of the analyses carried out, the summary of the results can be listed as follows: A Wilcoxon signed-ranks test indicated that the pre-test scores of the participants for the SI performance was statistically significantly higher than the post-test scores of the participants for the SI of a) sequential items, where $z = -3,674$, $p < .05$, b) lexical events where $z = -3,348$, $p < .05$, and figures where c) $z = -3,203$, $p < .05$. In addition, a Spearman's rank-order correlation was run to determine the relationship between 20 students' dual n-back levels (scores) and SI performance post-test scores. According to the results; there was a) a positive correlation between the dual n-back levels (scores) of the participants and their SI performance post-test scores on sequential events which is statistically insignificant ($r_s(20) = .305$, $p = .192$) and on lexical items which is statistically insignificant ($r_s(20) = .040$, $p = .867$), b) a strong positive correlation between the dual n-back levels (scores) of the participants and their SI performance post-test scores on figures which is statistically significant ($r_s(20) = .758$, $p = .000$). KR Formula 20 was also calculated in order to a) determine the internal consistency reliability of the tests prepared and b) see the relation between the difficulty level of each question and the scores of the participants considering that question.

According to the data, it can be concluded that the results prove the hypothesis: "Working memory training improves the simultaneous interpreting performance" as the null hypothesis is rejected by the outputs revealed by the Wilcoxon signed-ranks test. It was statistically proved that the working memory training through dual n-back task

improved the simultaneous interpreting skills of the 3rd year students in terms of interpreting sequential events, lexical items, and figures embedded in the passages which are normally provided by the speaker as input. These results also found support by the responses given to the Questions 1, 2, 3 and 7 included in the Questionnaire.

5.2. EVALUATION OF THE RESULTS

According to the data gathered from the KR Formula 20, calculated for both determining the internal consistency reliability and finding out the degree of the difficulty each question seems to have, some questions notably differed from each other in terms of the difficulty level. Within this context, the most difficult questions in the pre-test were respectively 22 ($p = 0.000$), 26 ($p = 0.050$), and 21 ($p = 0.050$) which were all included in the last chapter of the test referring to the interpretation of figures. The most difficult question seemed to be the 22. Question, which involved a full date with a day, month and year. Following questions, 26 and 21 included 3-digit numbers. On the other hand, the least correctly-answered questions seemed to be respectively 22 ($p = 0.150$), 26 ($p = 0.200$) and 21 ($p = 0.200$). This also proved the fact that although the dual n-back training improved students' ability of interpreting an input including figures (supported by the responses given to question 7 in the Questionnaire) the most difficult aspect of simultaneous interpreting still keeps to be those related to the numeric data. The reason of this may be the notion that participants found it relatively difficult to visualize the numbers in their minds and the fact that they exercised with letters, not figures, in the dual n-back task. One may tend to remember words by associating them to objects or concepts in their environments but it is generally not a usual behaviour to try to recall figures by relating them to visual info. Participants obviously had difficulty in recalling a figure because they could not create a synchronical image for it in their working memories and the information swiftly decayed due to the lack of any chunks (Miller, 1956) because they were not familiar numbers to them. Therefore, this considerable improvement in the results considering the capacity of recalling and interpretation of figures can be claimed to be one of the consequences of the dual n-back training when some specific data are taken into account such as the previously

mentioned studies claiming that WM shares common neural networks with attentional control (Kane et al., 2001; Bleckley et al., 2003; Fukuda and Vogel, 2009) and phonological loop (Baddeley, 2007) which were both proved to be improved by WM training and are the essential components of WM underlying the ability of interpreting in simultaneous mode (Van Hoof, 1960 & Timarova, 2007).

Wilcoxon signed-ranks test results revealed that there is a positive but statistically insignificant correlation between the pre-test and post-test results of simultaneous interpretation performances. On the other hand, Spearman & Brown Correlation Coefficient calculations regarding the simultaneous interpretation of sequential events ($r_s(20) = .305$, $p = .192$) and lexical items ($r_s(20) = .040$, $p = .867$) showed that the relation between dual n-back scores and the ability of students to maintain, process and update components in a subordinate was stronger and the degree of the correlation between interpreting subordinates and the dual n-back task seemed to exceed the degree of the correlation between interpreting lexical items and WM training. Both skills exhibited a significant degree of improvement but participants seemed to better improve their abilities to recall subordinates than their ability to maintain and process single words. This might at first sight look like a surprising outcome as it has been known that subordinates are relatively difficult to keep in mind and process than single words. Due to the long-distance relations between the words of a sentence, the interpreter as a listener often needs to keep various and relatively a bigger amount of material in mind while waiting for future input that is to be connected to earlier parts of the sentence. In addition, the presence of a noun phrase is often predictive of a to-be-encountered verb phrase. Such dramatic dependence on predictions put additional demands on working memory to maintain the information required, in particular when a subordinate clause is located in between the noun and its verb (Stefan & Thijs), which was the case in the passages included in the pre-test and post-test in this study. In this experiment, the subordinate expected to be recalled was replaced between the noun and its verb in the passages included in the tests as in the example below where the Question 2 in the pre-test is cited (See Annex 1 and 2 for further examples).

“What we know today about sleep is limited. In short, we can say that stage 1 is the stage that usually occurs between sleep and wakefulness. In stage 2, the individual gradually gets into deep sleep. In stage 3, the individual is less responsive to the

environment. In 4th stage, most muscles are paralyzed. Stage 5 is the stage when you dream. However, we should note that in stage 1, (when)....., the muscles are active.” (n--5)

Moreover, the linguistic structures of two languages (English-Turkish) are different from each other as English is a SVO while Turkish is a SOV language, which additionally push the limits of working memory. For such language pairs, the interpreter needs to wait until the first meaningful chunk of information is received and maintain this within the limits of working memory until the encoding of it is provided in the target language (mother tongue). Furthermore, while verbal memory is an essential component of SI (Daro and Fabbro, 1994) and verbal working memory is proved to be improved by WM training by meta analyses (Schwaighofer et al. 2015), the relation between WM training task (dual n-back task) scores and interpreting single words seems to be weaker than the relation between WM training and interpreting subordinates in this study. Subordinates requires the maintenance and reformulation of many sequential linguistic units instead of a single word which challenges the constraints of WM and the performance depends more on the WM capacity. Therefore, it can be concluded that the WM training created a bigger improvement on this aspect, when compared to its effect on the maintenance of single words because the ability of recalling and processing various linguistic units depends more on the WM capacity when compared with lexical items alone. In other words, the reason might be the fact that, when trying to keep more and various kinds of linguistics components in mind such as verbs, subjects and conjunctions and to update them, one depends on the specific cognitive skills that dual n-back task has been claimed to improve. For example, one needs to manage a stronger attentional control (Fukuda & Vogel, 2009) and resistance to being distracted by interfering information (Fukuda & Vogel, 2011) when interpreting complex subordinates. In contrast to subordinates, recalling words do not require all of those complex cognitive skills and that might be the reason why the correlation between the dual n-back scores and interpreting lexical items was weaker than the one between dual n-back scores and interpreting subordinates.

The results considering the questions' level of difficulty and the success rate of participants regarding the interpretation of lexical items and subordinates were also supported by the data gathered by the KR Formula 20. According to the outputs of

calculations, the easiest part in the pre-test seems to be interpretation of lexical items in Questions 14, 10, 30, 13, 25 and 18 respectively. Question 30 and 25 were naturally founded easy because it was an example of n-1 where the participants needed to recall the last item before the question. Therefore, it can again be concluded that the participants tend to interpret the lexical items easily already before the training was received, due to the smaller amount of cognitive load and lower degree of dependency on the constraints of WM.

In summary, the Pearson Brown Correlation Coefficient calculations illustrate that the strongest positive and statistically most significant correlation is found between the dual n-back levels (scores) and simultaneous interpretation of figures where $r_s(20) = .758$, $p = .000$. Therefore, it can be concluded that as the dual n-back levels (scores) of the participants increased, their SI performance also increased, which leads to the suggestion that dual n-back task improved the ability of recalling numbers, dates and numeric data. Simultaneous interpretation of lexical items and events, however, didn't exhibit such positive results. According to the data, it can be concluded that there is a) "weak but positive" relation between the dual n-back levels (scores) and simultaneous interpretation of events ($r_s(20) = .305$, $p = .192$) and b) a weaker but still positive relation between the dual n-back scores and SI of lexical items ($r_s(20) = .040$, $p = .867$). Therefore, the data provided by the Pearson Brown Correlation Coefficient analysis also confirmed that the relation between the training through the dual n-back task and SI of events was the second strong correlation after the one between the WM training and SI of figures.

5.3. QUESTIONNAIRE

A questionnaire was administered to the students at the end of the training after the post-test was conducted. The most remarkable results gathered from the questionnaire are indicated below.

- 95% of the participants reported that they feel better at interpreting in simultaneous mode.

- %80 of the participants remarked that they think they are now better able to focus on their work and maintain their attention on their performance which confirms Fukuda, K., & Vogel, E. K. (2009).
- %60 of the participants stated that now they can better deal with the “time-lag” while doing simultaneous interpretation.
- %75 of the participants indicated that the training helped them to better recall figures and dates.
- %70 of the participants pointed that, especially at the beginning of the WM training, they feel physically challenged while exercising the dual n-back task.
- %55 of the participants stated that they are now better able to remember their daily activities.
- %55 of the participants indicated that after the training, they can better and faster comprehend what they read which supports Daneman, M., & Carpenter, P. A. (1980)
- %55 of the participants expressed that the training helped them to better ignore the interfering information when interpreting in simultaneous mode which supports Tsuchida, Y., Katayama, J., & Murohashi, H. (2012).
- %65 of the participants stated that they will keep exercising the dual n-back task for their further personal development.

The main function of this questionnaire was to collect some personal views on the WM training from people who personally exercised the dual n-back task for two months. The results generally lead to the conclusion that most of the participants are content with the WM training they received and a big percent of them claims that their simultaneous interpretation performance improved after the 2-month training. Furthermore, article 1, 2, 4, and 8 are in compliance with the results provided by the results of the analyses carried out.

CONCLUSION

The aim of this study was to see if the working memory training created any improvements in the general simultaneous interpretation performance of the translation & interpretation students. The study also sought to know on which components of the interpreting process the working memory training through dual n-back task would create a significant difference in terms of the scores gathered with pre-test and post-test. The results of the analyses confirmed that the working memory training improved the general simultaneous interpretation performances of students, providing evidence that the dual n-back task was an effective training application to enhance the WM capacity and its components such as updating information and interference control that were of paramount significance when determining the quality of the outputs generated by simultaneous interpretation.

The study was built upon the question: “Is there a significant difference between the pre-test and post-test simultaneous interpreting scores of the participants who received working memory training through dual n-back programme?” and was set out to explore the answers of these questions:

- 1) Is there a significant difference between the pre-test and post-test simultaneous interpreting performance scores of the participants in terms of recalling capacity of sequential events?

Participants consisting of twenty 3rd year students at the Department of Translation & Interpretation were subject to the working memory training through the dual n-back task for two months and the experiment was conducted through a single-group pre-test post-test design. The results of the Wilcoxon signed-ranks test revealed that there is a significant difference between the the pre-test and post-test simultaneous interpretation performance scores of the participants in terms of the recalling capacity of sequential events. It can be concluded that the scores significantly differed before and after the training.

- 2) Is there a significant difference between the pre-test and post-test simultaneous interpreting performance scores of the participants in terms of the recalling capacity of lexical items?

The results of the Wilcoxon signed-ranks test revealed that there was a significant difference between the the pre-test and post-test simultaneous interpreting performance scores of the participants in terms of the recalling capacity of lexical items. It can be concluded that the scores significantly differed before and after the training.

- 3) Is there a significant difference between the pre-test and post-test simultaneous interpreting performance scores of the participants in terms of the recalling capacity of figures?

The results of the Wilcoxon signed-ranks test revealed that there is a significant difference between the the pre-test and post-test simultaneous interpreting performance scores of the participants in terms of recalling capacity of figures. It can be concluded that the scores significantly differed before and after the training.

- 4) What is the success level of the participants receiving the dual n-back training programme?

The outputs revealed by the Wilcoxon signed-ranks test pointed out that most of the participants improved their competence and ability of interpreting sequential events (positive ranks: 18), lexical items (positive ranks: 16) and figures (positive ranks: 14). Moreover, the correlation between the dual n-back scores of the participants and their simultaneous interpretation scores for sequential events, lexical items and figures are all considered positive which leads to the conclusion that the simultaneous interpretation scores of participants increased as their WM training scores increased. Depending on the fact that the simultaneous interpretation courses that the students regularly attended during these two months only covered the notion of “simultaneity” of the activity and strictly avoided the teaching of any specific vocabulary and any recalling or interpretation strategies, it can be claimed that the difference between the scores were due to the WM training.

- 5) Is there a correlation between the dual n-back levels and the simultaneous interpreting scores of the participants?

The outcomes revealed by the Pearson & Spearman Correlation Coefficient calculations illustrated that the dual n-back task scores and the simultaneous interpretation scores of the participants positively correlated. The strongest correlation between the working memory training and SI performance was found for “figures” followed by events and words respectively. According to the data, it can be deduced that although the working memory training improved all of the three components handled in this study (interpretation of events, lexical items, figures), the strongest correlation between the WM training and the simultaneous interpretation scores were observed for figures which was previously observed to be the most difficult section in the pre-test. Such an outcome might be an indicator of the fact that the improvement of the focus of attention and the capacity of short-term memory and working memory was observed at the utmost for figures because the utmost energy consumed during simultaneous interpretation is always required for the maintenance and processing of numbers rather than words or subordinates. In other words, the pre-test and post-test results showed that more mental effort was necessary for the storage and interpretation of figures because it is known numbers are difficult to be matched with any visual information or concepts in the visual word form area (VWFA). In other words, it is always more difficult to maintain figural data in the working memory due to the lack of any images for word sense disambiguation (Barnard et al., 2003, Barnard et al., 2005) in order to match pictures with words and orthographic visualisation as already learned words are known to be stored as pictures in the brain’s visual dictionary (Glezer et al., 2015). For figures are indefinite and thus impossible to be stored as pictures in the long-term memory in order to later be retrieved in the working memory, a figure in a text is always novel and unfamiliar to the listener. This fact underlines the dramatic demand on the WM capacity, which is known to be responsible for the temporary storage and processing of the new, as well as the previously stored information, for the interpretation of figures and this notion was supported with the results of this study.

In addition, working memory techniques are easier to be applied for words or a chain of words (sequential events) but figures generally depend on the constraints of the working

memory and short-term memory capacity to a greater extent. At this point, it should be emphasized that the linguistic structures of two languages (English-Turkish) differ from each other in terms of the subject, objects, verb ordering. For this experiment, this differentiation caused additional cognitive loads for the interpreter as more linguistic units were required to be stored in the WM until enough amount of linguistic units accumulated so that an appropriate and equivalent discourse could be generated in the target language. For this reason, WM capacity is of a greater significance for interpreters when interpreting events (expressed with various lexical units) compared with single lexical items.

The current study contributes to the previous data that suggest common neural networks between the WM components and cognitive skills underlying simultaneous interpretation and the effectiveness of WM training. In line with the data revealed, it can be suggested that WM training through dual n-back task improves not only the ability of recalling single words, but also, and in fact to a greater degree, the ability of recalling figures and events which support the claims that WM training causes transfer effects. It can also be claimed that the general improvement in the SI performance depends on the improvement of the non-trained tasks such as the control of the focus of attention, updating information and task-switching (Lilienthal L, Tamez E, Shelton JT, Myerson J, Hale S, 2013) because these are the essential prerequisites for interpreting in simultaneous mode. The finding that the most significant difference has been observed in the interpretation of figures underlines that they are now 1) better able to focus on their work and maintain their attention on their performance which confirms Fukuda, K., & Vogel, E. K. (2009), 2) better deal with the “time-lag” while doing simultaneous interpretation, 3) better recall figures and dates which is also supported by the analyses, 4) better and faster comprehend what they read which supports Daneman, M., & Carpenter, P. A. (1980), and 5) better ignore the interfering information when interpreting in simultaneous mode which supports Tsuchida, Y., Katayama, J., & Murohashi, H. (2012). Substantially, this study illustrated to what degree the working memory training may contribute to the core skills essential for simultaneous interpretation and for which processes do the researchers need a relatively deeper insight.

Future research should be more concentrated on the further investigation of which specific cognitive skills can be improved by WM training that is of vital prominence for simultaneous interpretation and to what degree these working memory training methods can be further developed. The outcomes of further relevant studies in cognitive neuroscience may promote researchers in SI to thoroughly comprehend which working memory components are vital for which process and interpreters may provide further data to researchers in cognitive science to develop advanced and up-to-date working memory training tasks. Following more concrete and reliable data on the transfer effects of working memory training, similar training methods may become a part of the curriculums of the Translation & Interpretation Departments of the Universities. Moreover, any further data on the working memory capacities of interpreters may provide a great deal of contribution to the treatment opportunities of people with language disorders because working memory is the key factor of many cognitive functions going on in the human brain on daily basis.

REFERENCES

- Abu-Rabia, S. "The Influence of working memory on reading and creative writing processes in a second language". *Educational Psychology*, 23, 209–222. Web. 2003.
- Alloway, T.P., Gathercole, S.E., Willis, C., & Adams, A-M. "A structural analysis of working memory and related cognitive skills in young children". *Journal of Experimental Child Psychology*, 87(2), 85-106. Web. 2004.
- Al-Salman, Saleh & Al-Khanji, Raja'i. "The Native Language Factor in Simultaneous Interpretation in an Arabic/English Context". *Meta: journal des traducteurs / Meta: Translators' Journal*, vol. 47, no. 4, 2002, p. 607-626. URI: <http://id.erudit.org/iderudit/008040ar>. Web. 14.08.2015.
- Altarriba, Jeanette Isurin, Ludmila. *Memory, Language, and Bilingualism. Theoretical and Applied Approaches*. First Paperback edition, pp. 114. Cambridge University Press. New York. July 17, 2014. Print.
- Anguera, J. A., Bernard, J. A., Jaeggi, S.M., Buschkuhl, M., Benson, B. L., Jennett, S., & Seidler, R. D. "The effects of working memory resource depletion and training on sensorimotor adaptation". *Behavioural Brain Research*, 228, 107–115. Web. 1st March 2012.
- Atkinson, R. C., & Shiffrin, R. M. Chapter: Human memory: A proposed system and its control processes. In Spence, K. W., & Spence, J. T. *The psychology of learning and motivation* (Volume 2). New York: Academic Press, pp. 89–195. Web. 1968.
- Au, J., Buschkuhl, M., Duncan, G. J., & Jaeggi, S. M. "There is no convincing evidence that working memory training is NOT effective: A reply to Melby-Lervåg and Hulme". *Psychonomic Bulletin & Review*. Abstract Web. Oct, 2015.
- Baddeley A. D, Hitch G. Working memory. In: Bower GH, editor. *The psychology of learning and motivation*. Vol. 8. New York: Academic Press; pp. 47–89. Web. 1974.
- Baddeley, A. D., Thomson, N., & Buchanan, M. "Word length and the structure of short-term memory". *Journal of Verbal Learning and Verbal Behavior*. 14, 575-589. Web. 1975.

- Baddeley, A. D. *Working memory*. Oxford Psychology Series, Oxford University Press, No. 11. Web. 1986.
- Baddeley, A., Gathercole S., Papagno, C. “The phonological Loop as a Language Learning Device”. *Psychol Rev.* Jan; 105 (1):158-73. Web. 1998.
- Baddeley, A. D. “The episodic buffer: A new component of working memory?” *Trends in Cognitive Sciences.* 4, (11): 417-423. Web. 2000.
- Baddeley A. “Working memory. Looking back and looking forward”. *Nature Reviews Neuroscience.* 4(10):829–839. PubMed. Web. 2003.
- Baddeley, A. “Working Memory and language: An Overview”. *ASHA* 2002, 36(3), 189-208. Web. 2003.
- Barik, H.C. “Simultaneous Interpretation: Temporal and Quantitie Data”. *Language and Speech* vol. 16 no. 3 237-270. Web. July 1973.
- Barik, H.C. “Simultaneous Interpretation: Qualitative and Linguistic Data”. The Ontario Institute for Studies in Education, Toronto. *Language and Speech.* Vol. 18 no. 3 272-297. Web. July 1975.
- Barnard, Kobus; Duygulu, Pinar; Forsyth, David; Freitas, de Nando; Blei, David M. Jordan, Michael I. “Matching Words with Pictures”. *Journal of Machine Learning Research.* 3(2003) 1107-1135. Web. February 2003.
- Barnard, Kobus; Johnson, Matthew; Forsyth, David. “Word Sense Disambiguation with Pictures.” *Artificial Intelligence.* Volume 167, Issues 1–2. Pages 13–30. Web. September 2005.
- Bajo, Teresa. Yudes, Carolina, and Pedro Macizo. “The Influence of Expertise in Simultaneous Interpreting on Non-Verbal Executive Processes.” *Frontiers in Psychology* 2 (2011): 309. PMC. Web. 25 Jan. 2016.
- Broadbent, Donald E. “Listening to one of two synchronous messages”. *Journal of Experimental Psychology.* 44: 51-55. Web. 1952.
- Buonomano, D.V. and Merzenich, M.M. “Cortical plasticity: from synapses to maps”. *Annu. Rev. Neurosci.* 21, 149–186. Web. 1998.
- Burgess, Gregory C. et al. “Neural Mechanisms of Interference Control Underlie the Relationship between Fluid Intelligence and Working Memory Span.” *Journal of experimental psychology.* General 140.4 (2011): 674–692. PMC. Web. 25 Jan. 2016.

- Butterfield EC, Wambold C, Belmont J.M. “On the theory and practice of improving short-term memory”. *Am. J. Ment. Defic.* 77, 654–669. Web. 1973.
- Carretti, B., Borella, E., Zavagnin, M., & de Beni, R. “Gains in language comprehension relating to working memory training in healthy older adults”. *International Journal of Geriatric Psychiatry*, 28, 539–546. doi:10.1002/gps.3859. Web. May 2013.
- Carey, P.W. “Delayed Auditory Feedback and the Shadowing Response”. Unpublished PhD thesis, Harvard University. Web. 1968.
- Carey, P.W. “Verbal retention after shadowing and after listening”. *Perception and Psychophysics*. Volume 9, Issue 1, pp.79-83. Web. January 1971.
- Cattell, R. B. “Intelligence: Its structure, growth, and action”. New York: *Elsevier Science*. Web. 1987.
- Chesterman, A. Arrojo, R. “Shared Ground in Translation Studies”. *Target* 12(1): 151-60. Web. 2000.
- Chincotta, Dino and Underwood, Geoffrey. “Simultaneous interpreters and the effect of concurrent articulation on immediate memory: A bilingual digit span study”. *Interpreting*, Volume 3, Number 1, 1998, pp. 1-20(20). Web. 1998.
- Christoffels Ingrid K, de Groot Anette M.B., Kroll Judith F. “Memory and language skills in simultaneous interpreters: The role of expertise and language proficiency”. *Journal of Memory and Language*. Volume 54, Issue 3, pp. 324–345. Web. April 2006.
- Clouter, Andrew. “The Effects of Dual n-back Training on the Components of Working Memory and Fluid Intelligence: An Individual Differences Approach”. Dalhousie University Halifax, Nova Scotia. Web. August 2013.
- Collados, Ais, A. “La incidencia del parámetro entonación”. In *Efforts and Models in Interpreting and Translation Research: A Tribute to Danile Gile*. Edt. by Gyde Hansen, Andrew Chesterman and Heidrun Gerzymishc-Argobast. John Benjamins B.V. Amstersam, the Netherlands. 2008. Print.
- Colom, Roberto Román Francisco J., Abad Francisco J., Shih Pei Chun, Privado Jesús, Froufe Manuel, Escorial Sergio, Martínez Kenia, Burgaleta Miguel, Quiroga M.A., Karama Sherif, Haier Richard J., Thompson Paul M., Jaeggi, Susanne M. “Adaptive n-back training does not improve fluid intelligence at the construct level:

- Gains on individual tests suggest that training may enhance visuospatial processing”. *Intelligence*. Volume 41, Issue 5, pp. 712–727 Web. 6 September 2013.
- Conway, A. R., & Getz, S. Cognitive ability: “Does working memory training enhance intelligence?” *Current Biology*. Volume 20, Issue 8, pp. R362–R364. Web. 27 April 2010.
- Cowan, N. *Attention and memory: An integrated framework*. Oxford Psychology Series, No. 26. New York: Oxford University Press. Paperback edition in 1997. Web. 1995.
- Cowan, N. *An embedded-processes model of working memory*. In A. Miyake & P. Shah (Eds.), *Models of working memory: Mechanisms of active maintenance and executive control*. NY: Cambridge University Press. 1999.
- Cowan N. “The magical number 4 in short-term memory: A reconsideration of mental storage capacity”. *Behavioral and Brain Sciences*. 24:87-185 [PubMed]. Web. 2001.
- Craik, F. I. M., & Lockhart, R. S. “Levels of processing: A framework for memory Research”. *Journal of Verbal Learning and Verbal behavior*, 11, 671-684. Web. 1972.
- Curtis, C. E. & D'Esposito, M. “Persistent activity in the prefrontal cortex during working memory”. *Trends Cogn Sci.*, 7, 415-423. Web. 2003.
- Daneman, M., & Carpenter, P.A. “Individual differences in working memory and reading”. *Journal of Verbal Learning and Verbal Behaviour*, 19(4), 450-466. Web. 1980.
- Daneman, M., & Tardif, T. “Working memory and reading skill re-examined”. In M. Coltheart (Ed.), *Attention and performance: Vol. 7*, (pp. 491–508). London: Erlbaum. Web. 1987.
- Darò, Valeria. “The role of memory and attention in simultaneous interpretation: A neurolinguistic approach”. *The Interpreters' Newsletter*. 2: 50-56. Web. 1989.
- Darò, Valeria. “Speaking speed during simultaneous interpretation: A discussion of its neuropsychological aspects and possible contributions to teaching”. In L. Gran & C. Taylor. *Aspects of Applied and Experimental Research on Conference Interpretation*, pp. 83-92. Udine: Campanotto Editore. 1990. Print.
- Darò, Valeria & Fabbro, Franco. “Verbal memory during simultaneous interpretation:

- Effects of phonological interference”. *Applied Linguistics* 15 (4): 365-381. 1994. Print.
- Darò, Valeria & Fabbro, F. “Attentional, auditory, and memory indexes as prerequisites for simultaneous interpreting. In *New Approaches in Translation Process Research*”. Edt. By Fabio Alves. Susanne Göpferlich, Fabio Alves, Inger M. Mees. Samfundslitteratur Rosenoerns Alle 9. DK-1970 Frederiksberg. Web. 2010
- De Smedt, B., Ghesquiere, P., & Verschaffel, L. “Working memory and arithmetic abilities in seven and eleven year old children”. Paper presented at the European Working Memory Symposium EQOMS II, Beaune, France. Web. April, 2004.
- Diamond, Adele. “Executive Functions”. *Annu Rev Psychol.* Author manuscript; available in PMC 2014 Jul 7. Web. 27 Sep 2012.
- Diamond, Bruce J., Lengenfeldera, Jean. Bryanta, Deborah. Kalmara, Jessica H., Moorea, John DeLuca Nancy B. “Processing speed interacts with working memory efficiency in multiple sclerosis”. *Archives of Clinical Neuropsychology.* Volume 21, Issue 3, pp. 229–238 Web. April 2006.
- Dillinger, M. *Comprehension during interpreting: What do interpreters know that bilinguals don't?* In S. Lambert & B. Moser-Mercer (Eds.) *Bridging the gap. Empirical research in simultaneous interpretation*, pp. 155-189. Amsterdam: Benjamins. 1994. Print.
- Dimitrova, B.E., Hyltenstam K. *Language Processing and Simultaneous Interpreting.* John Benjamins Publishing Company. Amsterdam/ Philadelphia, pg.67-68. 2000. Print.
- Dodds, J. “Linguistic theory construction asa premise to a methodology of teaching interpretation”. In L. Gran & J. Dodds. (Eds). *The theoretical and practical aspects of teaching interpretation* (pp. 17-20). Udine: Campanotto Editore. Web. 1989.
- Doğan, A. “Sözlü Çeviride Gölgeleme Alıştırmasının Bilişsel Dayanakları”. *Hacettepe Üniversitesi Edebiyat Fakültesi Dergisi.* Cilt: 20/ Sayı: 2/ ss.117-125. 2003. Web.
- Doğan, A. ve Kafadar, H. “Mütercim Tercümanlık Bölümü Öğrencilerinin Kısa Süreli Bellek Düzeyleri (Short-term Memory Levels of the Students of Translation and Interpretation Department)”. *Çeviribilim ve Uygulamaları (Journal of Translation Studies).* Ankara, Bizim Büro Basımevi. 1998. Print.

- Dosenbach NU, Fair DA, Cohen AL, Schlaggar BL, Petersen SE. "A dual-networks architecture of top-down control". *Trends CognSci.* 12:99–105. Web. 2008.
- Elmer S, Hänggi J, Jäncke L. "Processing demands upon cognitive, linguistic, and articulatory functions promote grey matter plasticity in the adult multilingual brain: Insights from simultaneous interpreters". *ResearchGate.* Web. May 2014.
- Engle, R. W., Kane, M. J., & Tuholski, S. W. "Individual differences in working memory capacity and what they tell us about controlled attention, general fluid intelligence, and functions of the prefrontal cortex". In A.Miyake& P. Shah (Eds.), *Models of working memory: Mechanisms of active maintenance and executive control* (pp. 102–134). Cambridge: Cambridge University Press. 1999. Print.
- Engle, R.W., Redick, T.S., Shipstead, Z. "Is Working Memor Training Effective?" *Psychol Bull.* 2012 Jul; 138(4):628-54. *Epub.* Web. 12th Mar. 2012.
- Ericsson, K. A., Chase W.G., Faloan, S. "Acquisition of a memory skill". *PubMed.* 208 (4448):1181–1182. Web. 1980.
- Ericsson, K. A., & Kintsch, W. "Long-term working memory". *Psychological Review,* 102, 211-245. Web. 1995.
- Ericsson, K. Anders and Delaney, Peter F. "Long-term working memory as an alternative to capacity models of working memory in everyday skilled performance". In *Models of Working Memory. Mechanisms of Active Maintenance and Executive Control,* A. Miyake and P. Shah (eds). Cambridge: Cambridge University Press. 257-297. 1999. Print.
- Fabbro, Franco. *Neurobiological Aspects of Bilingualism and Polyglossia.* In Fundamental Aspects of Interpreter Education: Curriculum and Assessment. Sawyer, David, B. Interpretation, Monterey Institute of International Studies. John Benjamins Publishing Company. Amsterdam/Philadelphia. pp. 237. 2004. Print.
- Fabbro, Franco, Gran L., Basso, G. and Bana, A. "Cerebral Laterization in Simultaneous Interpretation". *Brain and Language.* 39: 69-89. Web. 1990.
- Fabbro, F., Gran, B., Gran L. "Hemispheric specialization for semantic and syntactic components of language in simultaneous interpreters". *Brain and Language.* 41, 1-42. Web. 1991.

- Fabbro, F., Gran, L. *Neurological and neuropsychological aspects of polyglossia and simultaneous interpretation*. In S. Lambert & B. Moser-Mercer (Eds.). *Bridging the gap. Empirical research in simultaneous interpretation*, pp. 273-317. Amsterdam: Benjamins. 1997. Print.
- Fabbro, Franco. *The Neurolinguistics of Bilingualism: An Introduction*. University of Trieste and Research Hospital “Eugenio Medea”, Bosisio-Parini (Lecco) Italy. Psychology Press, Taylor & Francis Group, New York, USA. 1999. Print.
- Franc, Stefan, L. & Trompenaars, Thijs. “Cross-linguistic differences in processing double-embedded relative clauses: Working-memory constraints or language statistics?” Shrvan Vasishth Department of Linguistics, University of Potsdam and School of Mathematics and Statistics, University of Sheffield. Abstract. Pdf file.
- Fukuda, K., & Vogel, E.K. “Human Variation in Overriding Attentional Capture”. *The Journal of Neuroscience*, 29 (27), 8726-8733. Web. 2009.
- Fukuda, K., & Vogel, E.K. “Individual Differences in Recovery Time From Attentional Capture”. *Psychological Science*, 22(3), 361-368. Web. 2011.
- García-Madruga, J. A., Elosúa, M. R., Gil, L., Gómez-Veiga, I., Vila, J. Ó., Orjales, I., & Duque, G. “Reading comprehension and working memory’s executive processes: An intervention study in primary school students.” *Reading Research Quarterly*, 48, 155–174. Web. 2013.
- Gathercole, S. E., Pickering, S. J., Knight, C., & Stegmann, Z. Working memory skills and educational attainment: Evidence from national curriculum assessments at 7 and 14 years of age. *Applied Cognitive Psychology*, 18, 1-16. Web. 2003.
- Gazzaniga, Michael S.; Ivry, Richard B.; Mangun, George R. *Cognitive Neuroscience: The Biology of the Mind*. W.W. Norton & Company; 2nd edition. USA. 2009. Print.
- Gerver, D. *The effects of source language presentation rate on the performance of simultaneous conference interpreters*. In E. Foulfce (Ed.) *Proceedings of the 2nd Louisville Conference on Rate and/or Frequency Controlled Speech*. University of Louisville, pp. 162-184. 1969. Print.
- Gerver, D. “Aspects of Simultaneous Interpretation and Human Information Processing”. Unpublished D.Phil. Thesis, Oxford University. In *A psychological approach to simultaneous interpreting*. *Meta* 20 (2): 119-128. Web. 1971.

- Gerver, David. "A psychological approach to simultaneous interpreting". *Meta* 20 (2): 119-128. 1975. DOI: 10.7202/002885ar. Web. 1975.
- Gerver, D. "Empirical Studies of Simultaneous Interpretation: A review and a Mode". In R. W. Brislin (ed.) *Translation: Applications and Research*, New York: Gardner Press, pp. 165-207. Web. 1976.
- Gile, D. *Basic Theoretical Components in Interpreter and Translator Training*. Dollerup, C. and Loddegaard. A. (eds). *Teaching Translation and Interpreting: Training, Talent and Experience*. Amsterdam: John Benjamins, 1992. Print.
- Gile, D. *Basic Concepts and Models for Interpreter and Translator Training*. Revised Edition. John Benjamins. Amsterdam & Philadelphia. 1995. Print.
- Gile, Daniel. *Conference Interpreting as a Cognitive Management Problem*. pp. 196-214. In: *Cognitive Processes in Translation and Interpreting*. Edited by: Danks, Joseph E., Gregory M. Shreve, Stephen B. Fountain, and Michael K. McBeath. Thousand Oaks, London and New Delhi, Sage Publications. 1997. Print.
- Gile, Daniel. *Basic Concepts and Models for Interpreter and Translator Training*. Revised edition, Université Paris 3 - Sorbonne Nouvelle. Amsterdam, John Benjamins. 1999. Print.
- Gile, D., Dam, H.V., Dubsclaff F., Martinsen, B., Schjoldager, A. *Getting Started in interpreting research: methodological reflections, personla accounts and advice for beginners*. John Benjamins B.V. Amsterdam. 2001. Print.
- Gile Daniel. "Local cognitive load in simultaneous interpreting and its implications for empirical research". Published in *Forum* 6:2.59-77. Web. 2008.
- Glezer, Laurie S.; Kim, Judy; Rule, Josh; Jiang, Xiong; Riesenhuber, Maximillian. "Adding Words to the Brain's Visual Dictionary: Novel Word Learning Selectively Sharpens Orthographic Representations in the VWFA". *The Journal of Neuroscience*. 35(12): 4965-4972. Web. 25 March 2015.
- Goldman-Eisler, F. Psycholinguistics: Experiments on Spontaneous Speech. *Lingua* 01/1970; 25(1):152-164. Web. 1970.
- Goldman-Eisler, F. Sequential Temporal Patterns and Cognitive Processes in Speech. *Language and Speech* Apr-Jun; 10(2):122-32 1967. Print.
- Golestani, Narly, Michel, Christoph, Hagman, Patric and Moser-Mercer, Barbara. "Expertise-dependent brain structural and functional plasticity in simultaneous

- language interpreters”. Swiss National Science Foundation Project 320030-122085. Web. 2008.
- Gran, L., & Fabbro, F. “The role of neuroscience in the teaching of interpretation”. *The interpreters' newsletter*. 1, 23-41. Web. 1988.
- Gran, L. “Interaction between memory and note-taking in consecutive interpretation”. In Ann Beylard-Ozeroff, Jana Kralova and Barbara Moser-Mercer (Ed.), *Translator's Strategies and Creativity: Selected Papers from the 9th International Conference on Translation and Interpreting, Prague, September 1995*. P. 146-156. John Benjamins Publishing Company, Amsterdam/Philadelphia. 1998. Print.
- Gran, L., Fabbro, F. “A dichotic-listening study on error recognition among professional conference interpreters.” 1991. Print.
- Green, A., Sweda-Nicholson, N., Vaid, J., White, N., & Steiner, R. “Hemispheric involvement in shadowing vs. interpretation: A time-sharing study of simultaneous interpreters with matched bilingual and monolingual controls”. *Brain and Language*, 39, 107-133. Web. 1990.
- Green, A., Vaid, J., Schweda-Nicholson, N., White, N., & Steiner. *Lateralization for shadowing vs interpretation: A comparison of interpreters with bilingual and monolingual controls*. In S. Lambert & B. Moser-Mercer (Eds.), *Bridging The Gap. Empirical Research. In Simultaneous Interpretation*, pp. 331-355. Amsterdam: Benjamins. 1994. Print.
- Hansen Gyde, Chesterman Andrew, Gerzymisch-Arbogast Heidrun. *Efforts and models in interpreting and translation research: a tribute to Daniel Gile*. John Benjamins B.V. Copenhagen Business School / University of Helsinki / Universität des Saarlandes. 2008. Print.
- Hansen Gyde & Gile, Daniel & Pokorn, Nike, K. *Why Translation Studies Matters*. John Benjamins B.V. Amsterdam / Philadelphia. 2010. Print.
- Hauenschild, Chrisa, Heizmann, Susanne. *Machine translation and translation theory*. Walter de Gruyter & Co. D-10785 Berlin. 1997. Print.
- Hervais-Adelman Alexis Georges, Golestani, Narly and Moser-Mercer Barbara. “Executive control of language in the bilingual brain: integrating the evidence from neuroimaging to neuropsychology”. *Front. Psychol.*, 15 September 2011 | doi: 10.3389/fpsyg.2011.00234. Web. 15 September 2011.

- HighIQPro. Available at: <http://www.iqincrease.com/highiqpro-faqs>. Web. 12 August 2015.
- Hill Nicole M. & Schneider Walter. Brain Changes in the Development of Expertise: *Neuroanatomical and Neurophysiological Evidence about Skill-Based Adaptations*. In The Cambridge handbook of expertise and expert performance, K. Anders Ericsson, Neil Charness, Paul J. Feltovich and Robert R. Hoffman (eds.), 653-682. Cambridge; Cambridge University Press. 2006. Print.
- Hitch, G.J. *Developmental fractionation of working memory*. In G. Vallar, & T. Shallice (Eds.), *Neuropsychological impairments of short-term memory*, pp. 221-2469. Cambridge, UK: Cambridge University Press. 1990. Print.
- Horvat, Marina. *The effect of Working Memory Training on Cognitive Abilities*. Master Thesis. 2014. Web. 25 July 2015.
- Huijbers Willem, Pennartz M Cyriel, Cabeza Roberto, Daselaar M Sander. “When Learning and Remembering Compete: A Functional MRI Study” Ed. Mick D Rugg. *PLoS Biology* 7.1 (2009): e1000011. PMC. Web. 25 February 2015.
- Hulme, C. “Language processing mechanisms and immediate memory: Possible implications for simultaneous interpreting”. Ascona II Workshop on Complex cognitive processes: simultaneous interpreting as a research paradigm, July 1-6-2000 Ascona, Switzerland. 2000. Web. 15 October 2015.
- Jaeggi, S. M., Seewer, R., NirKKo, A. C., Eckstein, D., Schroth, G., Groner, R., et al., “Does excessive memory load attenuate activation in the prefrontal cortex? Load-dependent processing in single and dual tasks: functional magnetic resonance imaging study”. *Neuroimage* 19(2) 210-225. Web. 2003
- Jaeggi, S. M., Buschkuhl, M., Jonides, J., & Perrig, W. J. “Improving fluid intelligence with training on working memory”. *Proceedings of the National Academy of Sciences*, 105, 6829– 6833 Web. 2008.
- Jaeggi, S.M., Studer-Luethi, B., Buschkuhl M., Su Yi-Fen, Jonides J., Perrig, W.J. “The relationship between n-back performance and matrix reasoning — implications for training and transfer”. *Intelligence*. Volume 38, Issue 6, Pages 625–635. Web. November–December 2010.

- Jaeggi Susanne M. & Buschkuhl Martin & Shah Priti & Jonides John. "The role of individual differences in cognitive training and transfer". *Mem Cognit.* 42(3):464-80. Web. April 2014.
- Jaeggi, S. M., Au J., Shhehan, E., Tsai, N. Duncan., D.J., Buschkuhl, M. "Improving fluid intelligence with training on working memory: a meta-analysis". *Psychon Bull Rev.* 22(2):366-772014. Web. April 2015.
- James, W. *The Principles of Psychology*, New York, Holt. Available at: <https://archive.org/details/theprinciplesofp01jameuoft>. 1890. Web. 26 March 2015.
- Jonides, J., Lewis, R. L., Nee, D. E., Lustig, C., Berman, M.G., & Moore, K. S. "The mind and brain of short-term memory". *Annual Review of Psychology*, 59, 193–224. Web. 2008.
- Just M.A., Carpenter P.A. "A capacity theory of comprehension: Individual differences in working memory". *Psychological Review.* 99:122–149. *PubMed*. Web. 1992.
- Kade and Cartellieri, C. "Some Methodological Aspects of Simultaneous Interpreting". *Babel* 17 (2): 12-16. Web. 1971.
- Kane Michael J, McVay, Jennifer C. "Conducting the train of thought. Working memory capacity, goal neglect, and mind wandering in an executive-control task". *Journal of Experimental Psychology: Learning, Memory, and Cognition*, 35 (1), 196-204. Web. 2009.
- Karbach, J., & Verhaeghen, P. "Making working memory work: A meta-analysis of executive-control and working memory training in older adults". *Psychological Science*, 25, 2027–2037. Abstract. Web. 2014.
- Kaplan, Robert B. *The Oxford Handbook of Applied Linguistics*. Second Edition. Oxford University Press. New York. pg. 492. 2010. Print.
- Khateb A, Abutalebi J, Michel CM, Pegna AJ, Lee-Jahnke H, Annoni JM. "Language selection in bilinguals: a spatio-temporal analysis of electric brain activity". *Int J Psychophysiol.* 65:201–213. Web. 2007.
- Kiewra KA, Benton SL. "The relationship between information-processing ability and Notetaking". *Contemporary Educational Psychology*, 13:33–44. Web. 1988.
- Kirchner, W. K. "Age differences in short-term retention of rapidly changing information". *Journal of Experimental Psychology*, 55(4), 352-358. Web. 1958.

- Klingberg, T., Forssberg, H., & Westerberg, H. "Training of working memory in children with ADHD". *Journal of Clinical and Experimental Neuropsychology*, 24, 781-791. Web. 2002.
- Klingberg, T., Fernell, E., Olsen, P., Johnson, M., Gustafsson, P., Dahlström, K. et al. "Computerized Training of Working Memory in Children with ADHD – a Randomized, Controlled Trial". *Journal of the American Academy of Child and Adolescent Psychiatry*, 44, 177- 186. Web. 2005.
- Klingberg T, Thorell LB, Lindqvist S, Bergman Nutley S, Bohlin G. "Training and transfer effects of executive functions in preschool children". *Dev Sci*. Jan; 12(1):106-13. Web. 2009.
- Klonowicz, Tatiana. "Putting ones's hearth into simultaneous interpretation". In *Bridging the Gap: Empirical Research in Simultaneous Interpretatio*, ed. By S. Lambert and B. Moser-Mercer, 213-224. Amsterdam: John Benjamins. 1994. Print.
- Köpke, B. & Signorelli, T. M. "Methodological aspects of working memory assessment in simultaneous interpreters". *International Journal of Bilingualism*, (Impact Factor: 0.76). 06/2012; 16(2):183-197. Web. 2011.
- Kurz, Ingrid. A look into the black box' - EEG probability mapping during mental simultaneous interpreting. In M. Snell-Hornby, F. Pöchhacker, & K. Kaindl (Eds.), *Translation studies: an interdiscipline*, pp. 199-208. Amsterdam/ Philadelphia: John Benjamins. 1994. Print.
- Kurz, Ingrid. "Watching the Brain at Work- An Explanatory Study of EEG Changes during Simlutaneous Interpreting (SI)". *The Interpreters' Newsletter*. 6:3-16. Web. 1995.
- Kurz, Ingrid. "Physiological stress responses during media and conference interpreting". Austria, University of Vienna. In Garzone, Giuliana and Maurizio, Viezzi. *Interpreting in the 21st Century: Challenges and opportunities: Selected papers from the 1st Forli Conference on Interpreting Studies*, Netherlands. John Benjamins Publishing B.V. 2002. Print.
- Kurtz and Ingrid. "Physiological stress during simultaneous interpreting: a comparison of experts and novices", EUT - Edizioni Università di Trieste. 2003. Pdf file.
- Kyllonen P.C., Christal, R.E. "Reasoning ability is (little more than) working-memory capacity?" *Intelligence*, 14:389–433. Web. 1990.

- Lambert W.E. "Psychological Approaches to Bilingualism, Translation and Interpretation". *Language Interpretation and Communication*. NATO Conference Series. Volume 6, pp. 131-143. Web. 1978.
- Lambert, Walker, D., & Lambert, L. *Learning and leading theory: A century in the making*. In L. Lambert et al., *The constructivist leader* (pp. 1-27). New York: Teachers College Press. Web. 1995.
- Lambert, S. *Information Processing among conference interpreters: A test of the depth-of-processing hypothesis*. 1989. In *Conference Interpreting: Current Trends in Research*. Edt by Yves Gambier, Daniel Gile, Christopher Taylor. John Benjamins B.V. Amsterdam. 1997, pp. 145. Print.
- Lambert, S. "Recognition and Recall In Conference Interpreters. Unpublished doctoral Dissertation". University of Stirling. 1983. In *Bibliography on Interpretation –I*. By AIIC. 2004. Web. 30 August 2015.
- Lawlor-Savage, Linette and M. Goghari, Vina. "Working Memory Training in Schizophrenia and Healthy Populations". *Behav Sci (Basel)*. 2014 Sep; 4(3): 301–319. Web. 3 September 2014.
- Lederer, M. *Simultaneous interpretation- Units of Meaning and Other Features*. In Pöchhacker and Shlesinger (eds) (2002), pp. 131-40. 1978/2002. Print.
- Lee, Y.O. "Translation problems between Korean and English reflecting their structural difference with respect to the translation of reported speech". *Translation Studies* 3(1), 59-81. Web. 2002.
- Lehrer, Jonah. *Booth Camp for Boosting IQ*. Available at: <http://www.wsj.com/articles/SB10001424052702304432304576371462612272884>. June 1, 2011. Web. 22 March 2015.
- Lilienthal L, Tamez E, Shelton JT, Myerson J, Hale S. "Dual n-back training increases the capacity of the focus of attention". *Psychon Bull Rev*. 20(1):135-41. Web. February, 2013.
- Liu, M. "Expertise in Simultaneous interpreting: A Working Memory Analysis". PhD dissertation, University of Texas at Austin. 2001. Pdf file.
- Liu, M., Schallert, D. L., & Carroll, P. J. "Working memory and expertise in simultaneous interpreting". *Interpreting*, 6, 19 – 42. Web. 2004.

- Massaro, D.W. Speech perception by ear and eye: A paradigm for psychological inquiry. Hillsdale, NJ: Erlbaum. 1987. Pdf file.
- McNab F, Klingberg T. “Prefrontal cortex and basal ganglia control access to working memory”. *Nat Neurosci* 11:103- 107. Web. 2008.
- McNab, Fiona, Leroux Gaelle, Stranda Fredrik, Thorell Lisa, Bergmana Sissela, Klingberg Torkel. “Common and unique components of inhibition and working memory: An fMRI, within-subjects investigation”. *Neuropsychologia*, 46(11):2668-82. Web. September 2008.
- McNab F, Varrone A, Farde L, Jucaite A, Bystritsky P, Forsberg H, Klingberg T. “Changes in cortical dopamine D1 receptor binding associated with cognitive training”. *Science*, 323:800-802. Web. 2009.
- Mecelli, A. Crinion, JT; Noppeney, U; O'Doherty, J; Ashburner, J; Frackowiak, RS; Price, CJ. “Structural plasticity in the bilingual brain, Proficiency in a second language and age at acquisition affect grey-matter density”. *NATURE*, 431 (7010) 757 - 757. 10.1038/431757a. Web. 2004.
- Melby-Lervag, M., & Hulme, C. “Is working-memory training effective? A meta-analytic review”. *Developmental Psychology*, 49, 270– 291. Abstract. Web. 2013.
- Metzger, Melanie. *Sign Language Interpreting: Deconstructing the Myth of Neutrality*. Gallaudet University Press; Washington DC, 1 edition. Pg.9. 11 March 1999. Print.
- Michelson, Patricia. *Interpreters in the judicial system: A handbook for Ohio judges*. 2000. Pdf file.
- Miller, G. “The magical number seven, plus or minus two: Some limits on our capacity for processing information”. *The psychological review*. 63, 81-97. Web. 1956.
- Moody, D. E. “Can intelligence be increased by training on a task of working memory?” *Intelligence*, Volume 37, Issue 4, Pages 327-328. Web. July–August 2009.
- Morales, Julia. Padilla, Francisca, Gomez-Ariza, Carlos J, Bajo, Maria Teresa. “Simultaneous Interpretation Selectively Influences Working Memory and Attentional Networks”. *Acta Psychologica* (Impact Factor: 2.26). 02/2015; 2015(155C):82-91. Web. February 2015

- Morrison, A. B., & Chein, J. M. “Does working memory training work? The promise and challenges of enhancing cognition by training working memory”. *Psychonomic Bulletin & Review*, 18, 46–60. Web. 2011.
- Moser, Barbara. “Simultaneous interpretation: A hypothetical model and its practical application”. In *Language Communication and Interpretation*, D. Gerver and H.W. Sinaiko (eds). New York / London: Plenum Press. 353-368. 1978. Print.
- Moser-Mercer, Barbara, Alexander Künzli and Marina Korac. “Prolonged turns in interpreting: Effects on quality, physiological and psychological stress”. Working Paper. University of Geneva, École de Traduction et d’Interprétation. Unpublished manuscript. 1996. Pdf file.
- Moser-Mercer, B. *Process models in simultaneous interpretation*. In C. Hauenschild & S. Heizmann. *Machine translation and translation theory*, pp. 3-18. The Hague, Netherlands: Mouton de Gruyter. 1997. Print.
- Moser-Mercer, Barbara. *The rocky road to expertise in interpreting: Eliciting knowledge from learners*. In Sawyer, David (Eds), *Fundamental Aspects of Interpreter Education: Curriculum And Assessment*. BenjaminsTranslations Library. Amsterdam, pp. 30. 2004. Print.
- Moser-Mercer, Barbara. *The search for neuro-physiological correlates of expertise in interpreting*. University of Geneva, Switzerland. In *Translation and Cognition*, eds. Shreve, G.M., Angelone, Erik. John Benjamins Publishing Company. Amsterdam/Philadelphia. 2010. Print.
- Moser-Mercer, B., Hervais-Adelman, A., Michel, C.M., Golestani, N. “fMRI of Simultaneous Interpretation Reveals the Neural Basis of Extreme Language Control”. *Cereb Cortex*. 2015 Dec; 25(12):4727-39 . Web. July 17, 2014.
- Moser-Mercer, B., Golestani, N., Hervais-Adelman, A., Michel, Christoph, Haggmann Patric. “Brain Plasticity in Interpreters”. University of Geneva. Interpreting Department. Virtual Institute. In progress. Last updated: Friday, January 2015. Web. 11 November 2015.
- Murray, D. J. “Language and psychology: 19th-century developments outside Germany: A survey”. In S. Auroux, E. F. K. Koerner, H.-J. Niederehe, & K. Versteegh (Eds.), *History of the language sciences/Geschichte der Sprachwissenschaften/Histoire des*

sciences du langage, Volume 2/2. Teilband/Tome 2 (pp. 1679–1692). Berlin: de Gruyter. Web. 2001.

- Goethe K, Oberauer K. “The integration of familiarity and recollection information in short-term recognition: Modeling speed–accuracy trade-off functions”. *Psychological Research*. PubMed 72:289–303. Web. 2008.
- Oelhafen, Stephan, Nikolaidis, Aki, Padovani, Tullia, Blaser, Daniela, Koenig, Thomas, Perrig, Walter J. “Increased parietal activity after training of interference control”. *Neuropsychologia*. 2013 Nov; 51(13):2781-90. Web. 25 August 2013.
- Oleron, P. And Nanpon, H. “Recherches sur la traduction simultanée”. *Journal de Psychologie Normale et Pathologique* 62 (1): 73-94. In Moser-Mercer Barbara. *Paradigms gained or the art of productive misunderstanding*. 1964. Web. 8 November 2015.
- Oleron, Pierre and Nanpon, Hubert. *Research into Simultaneous Translation*. In F. Pöchhacker and M. Schlesinger (eds) *The Interpreting Studies Reader*, London and New York: Routledge, 43-50. [1965] 2002. Print.
- Olsen, P., Westerberg, H., & Klingberg, T. “Increased prefrontal and parietal brain activity after training of working memory”. *Nature Neuroscience*, 7, 75-79. Web. 2004.
- Owen, A. M. “The functional organization of working memory processes within human lateral frontal cortex: the contribution of functional neuroimaging”. *Eur J Neurosci*; 9(7):1329-39. Web. July, 1997.
- Owen, A.M., Hampshire, J.A. Grahn, R. Stenton, S. Dajani, A.S. Burns, R.J. Howards, and C.G. Ballard. “Putting Brain Training to the Test”. *Nature* 464, no. 1111: 775-778. Web. 2010.
- Padilla, Presentación, Bajo, María Teresa, Cañas, José Juan and Padilla, Francisca. “Cognitive processes of memory in simultaneous interpretation”. In *Topics in Interpreting Research*, J. Tömmola (ed). Turku: University of Turku Press. 61-71. 1995. Print.
- Paneth, E. “An Investigation into Conference Interpreting (with special reference to the training of interpreters),” unpublished MA Thesis, University of London. 1957. Pdf file.

- Paradis, M. "Prerequisites to a study of neurolinguistic processes involved in simultaneous interpreting. A synopsis". In *Language processing and simultaneous interpreting: Interdisciplinary perspectives*. Englund B., Dimitrova, K. Hyltenstam (eds), 17-24. Amsterdam/Philadelphia: John Benjamins. 2000. Print.
- Pickering, S. (Ed.). *Working memory and education*. Oxford: Elsevier. 2006. Chapter 8. Pdf file.
- Pinter, Ingrid. *Der Einfluss der Übung und Konzentration auf Simultanes Sprechen und Hören. Unpublished doctoral dissertation, University of Vienna*, 167 pages. 1969. In Gyde Hansen, Andrew-Chesterman and Heidrun Gerzymisch-Arbogast. *Efforts and Models in Interpreting and Translation Research: A Tribute to Daniel Gile*. John Benjamins Publishing Company. Amsterdam/Philadelphia. Pp.28-29. 2008. Print.
- Pöchhacker, Franz & Shlesinger, Miriam. *The Interpreting Studies Reader*. Routledge. 11 New Fetter Lane, London EC4P 4EE. 2002. Print.
- Pöchhacker, Franz. *Introducing Interpreting Studies*. By Routledge Taylor & Francis Group. 11 New Fetter Lane, London EC4P 4EE. 2004. Print
- Preece, David. *The Effect of Working Memory (n-back) Training on Fluid Intelligence*. Faculty of Computing, Health, and Science. Edith Cowan University. 2011. Pdf file.
- Pribriam, Karl H.; Miller, George A.; Galanter, Eugene. Plans and the structure of behaviour. *The American Journal of Psychology* (Impact Factor: 1.09). 03/1962; 75(1). Web. March, 1962.
- Proverbio, Alice Mado, Adorni Roberta. "Hemispheric Asymmetry for Language Processing and Lateral Preference in Simultaneous Interpreters". Lab of Cognitive Electrophysiology, Department of Psychology, University of Milano-Bicocca, Milan Italy. 2011. Pdf file.
- Qiu, Feiyue, Wei Qinqin, Zhao Liying, Lin Lifang. "Study on Improving Fluid Intelligence through Cognitive Training System Based on Gabor Stimulus". The 1st International Conference on Information Science and Engineering (ICISE2009). 2009. Web. 11 August 2015.
- Quaresima V, Ferrari M, van der Sluijs MCP, Menssen J, Colier W. "Lateral frontal cortex oxygenation changes during translation and language switching revealed by

- non-invasive near-infrared multi-point measurements”. *Brain Res Bull.* 59:235–243. Web. 2002.
- Rabipour, S., & Raz, A. “Training the brain: Fact and fad in cognitive and behavioral remediation”. *Brain and Cognition*, 79,–179. Web. 2012.
- Redick, T. S., Shipstead, Z., Harrison, T. L., Hicks, K. L., Fried, D., Hambrick, D. Z., & Engle, R. W. “Running Head: No evidence of intelligence improvement after working memory training: A randomized, placebo-controlled study”. *Journal of Experimental Psychology: General*, 142, 359–379. Web. 2013.
- Rennert, Sylvie. “Visual Input in Simultaneous Interpreting”. *Meta: journal des traducteurs / Meta: Translators' Journal*. Volume 53, numéro 1, p. 204-217. Web. 2008.
- Riccardi, Alessandra. “Interpreting Strategies and Creativity”. In: A. Beylard-Ozeroff/J. Králová/B. Moser-Mercer (eds), John Benjamins Publishing Company, Amsterdam/Philadelphia. Pp. 171–179. 1998. Web. 13 September 2015.
- Riccardi, Alessandra. “On the Evolution of Interpreting Strategies in Simultaneous Interpreting”. *Meta: Translators' Journal* 50/2, 753–767. Web. 2005.
- Rinne JO, Tommola J, Laine M, Krause BJ, Schmidt D, Kaasinen V, Teras M, Sipila H, Sunnari M. “The translating brain: cerebral activation patterns during simultaneous interpreting”. *Neurosci Lett.*294:85–88. Web. 2000.
- Rueda M.R., Rothbart M.K., McCandliss B.D., Saccomanno L., Posner M.I. “Training, maturation, and genetic influences on the development of executive attention”. *Proc. Natl. Acad. Sci. USA*; 102:14931–14936. *PubMed*. Web. 2005.
- Rudebeck, S. R., Bor, D., Ormond, A., O’Reilly, J. X., & Lee, A. C. “A potential spatial working memory training task to improve both episodic memory and fluid intelligence”. *PLoS ONE*, 7, e50431. Web. 2012.
- Salminen, Tiina, Tilo Strobach, and Torsten Schubert. “On the Impacts of Working Memory Training on Executive Functioning.” *Frontiers in Human Neuroscience* 6 (2012): 166. *PMC*. Web. 24 Jan. 2016.
- Scott A. Huettel, Allen W. Song, Gregory McCarthy. “Functional Magnetic Resonance Imaging”. New York. Freeman. 2009. Web. 13 January 2015.
- Seeber, G. Kilian. *Cognitive Load in simultaneous interpreting: Existing Theories- new models*. University of Geneva. John Benjamins Publishing Company. 2011. Print.

- Seeber, G. Killian, Kerzel Dirk. "Cognitive Load in simultaneous interpreting: Model meets data". University of Geneva, Switzerland. *International Journal of Bilingualism*. Web. 23 June 2011.
- Seleskovitch, D. *Language and Memory: Study of Note-Taking in Consecutive Interpreting*. 1975. In *The Interpreting Studies Reader*. Edt by Pöchhacker and Schlesinger 2002. Pp.121.-9. Print.
- Signorelli, Teresa M & Obler Loraine. "Working Memory in Simultaneous Interpreters". In *Memory Language and Bilingualism: Theoretical and Applied Approaches* by Altarriba, Jeanette; Isurin Ludmila. England. Cambridge University Press, 2014. Print.
- Siliang, Huo. "Grammatical Performance in Simultaneous Interpretation: An Error Analysis". The Chinese University of Hong Kong. June, 2005. Pdf file.
- Shah, P. & Miyake, A., (Eds.) *Models of working memory: Mechanisms of active maintenance and executive control*. New York: Cambridge University Press, pp. 1-28. 1999. Print.
- Shreve, Gregory M. Angelone Erik. *Translation and Cognition*. John Benjamins Publishing Company. Amsterdam/Philadelphia, pg.277-278. 2010. Print.
- Smith, Mark Ashton. "Working Memory Training Literature Review". CogPsyLab. Pdf file. Available at: <http://markashtonsmith.info/working-memory-training-review/>
- Smith, Mark A. "How to Optimize Your Dual N-Back Training: For i3 Mindware v.4". Pdf file. Available at: <http://www.i3mindware.com/wp-content/uploads/2014/07/How-To-Optimize-Your-Dual-N-Back-Training-Mark-Ashton-Smith-PhD.pdf>
- Smith, Mark A. "Neuroplasticity Mechanisms of Working Memory (WM) Training Transfer: How Brain Training Works". December 10, 2015. Pdf file. Available at: <http://www.hrplab.org/working-memory-training-brain-mechanisms/>.
- Spivey, Michael; J, McRae, Ken; Joanisse, Marc F. *The Cambridge Handbook of Psycholinguistics*. Cambridge University Press, New York, NY 10013-2473, USA. 2012. Print.
- Stavarakaki S, Megari K, Kosmidis MH, Apostolidou M, Takou E. "Working memory and verbal fluency in simultaneous interpreters". *J Clin Exp Neuropsychol*. 2012; 34(6):624-33. Epub. Web. 2012 Mar 21.

- Stephenson, C. L., & Halpern, D. F. “Improved matrix reasoning is limited to training on tasks with a visuospatial component”. *Intelligence*, 41, 341–357. Web. 2013.
- Stephenson & Halpern. “Does training to increase working memory capacity improve fluid intelligence?” Claremont Graduate University. 2010. Pdf file.
- Stephenson & Halpern. “Improved matrix reasoning is limited to training on tasks with a visuospatial component”. *Intelligence* 41 (5), 341-357. Web. 2013.
- Strobach T, Becker M, Schubert T and Kühn S. “Better dual-task processing in simultaneous interpreters”. *Front. Psychol.* 6:1590. Web. 2015
- Strolz, B. “Simultankapazität und Übungseffekt”. In M. Snell-Hornby, F. Pöchhacker & K. Kaindl (eds.), *Translation Studies. An Interdiscipline*, Amsterdam, Benjamins, p. 209-218. 1994. Print.
- Sunnari, Marianna. *Processing strategies in Simultaneous Interpreting: Saying it all vs. Synthesis*. In J. Tammola /Ed.), *Topics in Interpreting Research* (pp.109-119). Turku: University of Turku. Centre for Translation and Interpreting. 1995. Print.
- Süß, H. M., Oberauer, K., Wittmann, W. W., Wilhelm, O., & Schulze, R. “Working-memory capacity explains reasoning ability - and a little bit more”. *Intelligence*, 20, 261-288. Web. 2002.
- Schwaighofer, M., Fischer, F., Buhner, M. “Does Working Memory Training Transfer? A Meta-Analysis Including Training Conditions as Moderators”. *Educational Psychologist* 50, 2. Abstract. Web. 2015.
- Takeuchi Hikaru, Sekiguchi Atsushi, Taki Yasuyuki, Yokoyama Satoru, Yomogida Yukihiro, Komuro Nozomi, Yamanouchi Tohru, Suzuki Shozo, Kawashima Ryuta. “Training of Working Memory Impacts Structural Connectivity”, *Journal of Neuroscience.*, 30 (2010): 3297 – 3303. Web. 2010.
- Takeuchi, H., Taki, Y., Nouchi, R., Hashizume, H., Sekiguchi, A., Kotozaki, Y., & Kawashima, R. “Effects of working memory training on functional connectivity and cerebral blood flow during rest”. *Cortex*, 49, 2106–2125. Web. 2013.
- Tan, H. Y., Chen, A. G., Kolachana, B., Apud, J. A., Mattay, V. S., Callicott, J. H., ... Weinberger, D. R. “Effective connectivity of AKT1-mediated dopaminergic working memory networks and pharmacogenetics of anti-dopaminergic treatment”. *Brain*, 135(5), 1436–1445. Web. 2012

- Timarova, Šárka. “Working Memory and Simultaneous Interpreting”. In P. Boulogne (Ed.), *Translation and its others: Selected papers of the CETRA Research Seminar in Translation Studies 2008*. Pdf file.
- Thompson TW, Waskom ML, Garel K-LA, Cardenas-Iniguez C, Reynolds GO, et al. “Failure of Working Memory Training to Enhance Cognition or Intelligence”. *PLoS ONE* 8(5): e63614. Web. 2013.
- Tommola J. and Hyönä J. “Mental load in listening, speech shadowing and simultaneous interpreting: A pupillometric study”. In *Foreign Language Comprehension and Production*. Edt. by J. Tommola, Turku, AFin LA. 1990. Print
- Tommola J. & Hyönä J. “The effect of training on cognitive load during simultaneous interpreting”, in *New Horizons - XIV World Congress of the Fédération Internationale des Traducteurs*. Web. 1996.
- Tommola, Jorma. *New trends in interpreting Research: Going Psycho – or Neuro?* In Anovar/anosar. *Estudios de traducción e interpretación*. A. Avarez Lugs and A. Fernandez Ocampo (eds.), 132i330. Vigo: Universidade de Vigo. Web. 1999.
- Treisman, A. *The effects of redundancy and familiarity on translating and repeating back a foreign and a native language*. 1965. *British Journal of Psychology* 56: 369-79. In *The Routledge Handbook of Interpreting*. Edt. by Holly Mikkelson, Renee Jourdenais. Routledge. New York, pp.63. Web. 2015.
- Tsuchida Y, Katayama J, Murohashi H. “Working memory capacity affects the interference control of distractors at auditory gating”. *Neurosci Lett*. 2012 May 10; 516(1):62-6. Epub. Web. 28 March 2012.
- Tzou, Y., Eslami, Z. R., Chen, H., & Vaid, J. “Effect of language proficiency and degree of formal training in simultaneous interpreting on working memory and interpreting performance: evidence from Mandarin–English speaker”. *International Journal of Bilingualism*. 16 (2), 213-227. Web. 2011.
- Vidal, Mirta. *New Study on Fatigue Confirms Need for Team Interpreting in Teams*. In *Interpreters in the Judicial System: A Handbook for Ohio Judges Appendix F*. Mirta Vidal, Proteus, April 1997. Edt by Lois Feuerle J.D., Ph.D. Interpreter Services Program 65 South Front Street, Columbus, Ohio. Web. 15th February 2015.

- Vogel EK, McCollough AW, Machizawa MG. “Neural measures reveal individual differences in controlling access to working memory”. *Nature* 438:500-503. Web. 2005.
- Von Bastian, C. C., & Oberauer, K. “Distinct transfer effects of training different facets of working memory capacity”. *Journal of Memory and Language*, 69, 36–58. doi:10.1016/j.jml.2013.02.002. Web. 2013.
- Wadenjsö, Cecilia., Dimitrova, Birgitta Englund., Nilsson, Anna-Lena. *The Critical Link 4. Professionalisation of interpreting in the community. Selected papers from the 4th International Conference on Interpreting in Legal, Health and Social Service Settings*. Stockholm, Sweden, John Benjamins Publishing Company Amsterdam/Philadelphia. 20-23 May 2004. Print.
- Wager D. T., Smith E.E “Neuroimaging studies of working memory”. *Cognitive, Affective, & Behavioral Neuroscience*. Volume 3, Issue 4, pp 255-274. Web. December 2003.
- Wang, Jun & Morgan, A. George. “Pre-experimental Designs”. In Salkind, Neil, J. *Encyclopedia of Research Design*. Volume 3. University of Kansas. USA: SAGE Publications, pp 1083-1085. Web. 2010.
- Wang, Y., Kuhl PK, Chen C, Dong Q. “Sustained and transient language control in the bilingual brain”. *Neuroimage*. 47:414–422. Web. 2009.
- Westerberg, Helena, Klingberg, Torkel. “Changes in cortical activity after training of working memory- a single-subject analysis”. Karolinska Institutet, Department of Neuropediatrics, MR Center N8:0, S-171 76 Stockholm, Sweden. Web. 2007.
- Wilss, W. “Syntactic Anticipation in German-English Simultaneous Interpreting”. In D.Gerver & H. Wallace Sinaiko (Eds.). *Language Interpretation and Communication*. New York/London: Plenum Press. Web. 1978.
- Wirl, Julius. *Grundsatzliches zur Problematik des Dolmetschens und des Übersetzens*, Vienna: Wilhelm Braumüller. 1958. Pdf file.
- Wise RJS. “Language systems in normal and aphasic human subjects: functional imaging studies and inferences from animal studies”. *Br Med Bull* 65: 95–119. Web. 2003.

- Witt, M. "School based working memory training: Preliminary finding of improvement in children's mathematical performance". *Advances in Cognitive Psychology*, 7, 7–15. Web. 2011.
- Anthony Wright. "Higher Cortical Functions: Language. Department of Neurobiology and Anatomy". The UT Medical School at Houston. 10 October 2015.
- Zelinski, E. M. "Far transfer in cognitive training of older adults". *Restorative Neurology and Neuroscience*, 27, 455–471. Web. 2009.
- Zinke, K., Zeintl, M., Eschen, A., Herzog, C., & Kliegel, M. "Potentials and limits of plasticity induced by working memory training in old-old age". *Gerontology*, 58, 79–87. Web. 2011.

APPENDIX 1

A. PASSAGES FOR SEQUENTIAL EVENTS

1. The circulation of the blood is a complicated issue. First, the blood is brought to the lungs. Second, it is cleaned in the lungs. Third, the clean blood is carried to the brain. Fourth, the brain feeds the brain cells with this blood. Fifth, brain cells activate our muscles to keep us alive with this blood. Stage 4, during which the, is extremely important because it is the brain controlling our body functions.
2. What we know today about sleep is limited. In short, we can say Stage 1 is the stage that usually occurs between sleep and wakefulness. In stage 2, the individual gradually gets into deep sleep. In stage 3, the individual is less responsive to the environment. In 4th stage, most muscles are paralyzed. Stage 5 is the stage, when you dream. However we should note that in stage 1, when, the muscles are active and the eyes roll slowly.
3. Each lunar phase can be identified by the appearance of the moon. First phase occurs when the moon is all dark. Second phase is observed when the moon starts to be seen with naked eye. The third phase is when half of the moon is visible. In phase four, the moon is nearly like a full moon. Fifth phase is when the moon is all lit up. The third phase, when, is called the banana phase.
4. Today we share an easy cake recipe on the internet. The directions are as follows: First, whisk eggs and strawberries together in a bowl. Second, add butter into the bowl. Third, melt some ice cream in another bowl. Fourth, add this ice cream into the mixture. Fifth, bake the mixture in the preheated oven. Please note that during the second step, when you, you should remember to mix it with a mixer.
5. There are five layers in the Earth's atmosphere. The outermost layer contains most of the satellites around the Earth. The second layer is completely cloudless. The third layer is where most meteors burn up. Fourth layer is the highest layer that jets can fly. In the fifth layer, the atmosphere is denser than all other layers. I need to say that this fifth layer, where, is also called the ozone layer.
6. The inspector went to the power plant because he wanted to monitor the air quality. He visited many departments in the plant. First, he had a look at the workplace to see the working conditions of people. Second, he visited the dressing rooms to see where people get dressed. Third, he walked to the director's office to see if he smokes. Fourth, he evaluated the hygiene conditions in the kitchen. Fifth, he controlled the application of safety precautions. At the fourth place, where he, he saw that the air quality was below the threshold value.
7. The teacher asked her students to write five ways the sun is useful to earth and the most popular answers were respectively as follows: First, it provides heat for Earth. Second, it is the only resource of solar energy. Third, it helps recycling of water. Fourth it holds the food chain together. And last, it provides vitamin D for humans. The 2nd most popular answer, which, was given mostly by women.

8. Human growth takes place in five stages. The first stage lasts from birth to eighteen months. During the second stage, one witnesses changes in linguistic development. In the third stage, the character starts to develop. In fourth stage, the child continues to rapidly grow in height. Fifth stage, adulthood, is when no significant cell growth occurs anymore. At stage 3rd, when, the child begins to learn rules.
9. Here is how the plants stay alive: First the sunlight is trapped in the leaves. Second, the food-making process starts. Third, the roots take nutrients up to the leaves. Fourth, leaves use water to make their food. Fifth, they throw out their waste. At the first step, when....., plants can be observed to grow in height.
10. There are descriptions of abilities to communicate in a language. At level 1, oral production is limited. At Level 2 individual can fulfil travelling needs. At level 3 one is able to satisfy social demands. At Level 4 individual can take place in serious conversations. At level 5, one can handle interpreting of the speech. At level 5, when, one can also meet high-level work requirements.

* People experience different stages of flue. In the 1st stage one will have weakness. In the 2nd stage increased thirst is seen and fever is observed in the 3rd stage. 4th stage is experienced when one has cough and 5th stage is when person needs to sleep constantly. In 3rd stage, when....., you should see a doctor.

* It is a difficult job to make a strawberry pie. First, you need to mix flour and milk. Second, put the mixture on a tray. Third, smash strawberries. Fourth, add smashed strawberries on the mixture. Fifth, bake it in the oven. At the fourth step, when....., pre-heat the oven.

B. PASSAGES FOR LEXICAL ITEMS

1. A conference was held in our city last week. The Ambassador of France spoke about legislation, the Undersecretary of Treasury about the latest statistics, the Minister of Health Foundation about the latest technology, the Minister of Agriculture about exportation of fruit and the Minister of Economy about international agreements. The one who spoke about the latest statistics,, was sitting next to the door.
2. There are certain foods that are on the most sold products list of countries. For example, canned food is the top product in Italy while soft drinks are sold mostly in England. Fresh fruits and vegetables are the most popular choice in Norway. Sweets are number one in Belgium. Frozen food is on the top in Spain. Fresh fruits and vegetables, which...., are preferred because they are healthy.
3. People have different tastes of food in USA. According to a study, high-income families prefer eating light food while low-income families are generally buying cereal products. Teenagers often like to eat at fast-food restaurants and people over 50s are favouring Chinese food. Additionally, middle-income families seem to like Italian cuisine. People over 50s, who, also seem to like spices.
4. People find various ways as means of livelihood. Fishery, for example is a mean of living in Asia. Agriculture should be mentioned for a way of living in Europe. Stockbreeding is observed in Africa while forestry is seen in America and people make pottery in Antarctica. Fishery, which, usually takes place in the villages.
5. Animals in the Zoo are going to be transferred to different natural parks because of the reparation. Horses are going to be carried to Northern Park and zebras will be transferred to the southern farm. Giraffes will go to the East Forest while elephants will be replaced in the west-coast natural park. Lamas will be accommodated in the north-east barn. Animals in the north-east barn, which, will stay there for a month.
6. Rogers Construction Industry has begun its courses to address some issues. The courses will be presented by different instructors. Hazard Control will be instructed by an expert from the industry. Vehicle Operation courses will be given by the director of a company. Environmental Hazards course will be carried out by the Ministry. Quality Control course will be given by an inspector and finally First Aid by a professor. Especially for the Environmental Hazards Course, which....., is attendance obligatory.
7. According to the article in today's journal, tourists are visiting seas and oceans in different seasons. The Pacific Ocean is generally visited in the summer while Atlantic Ocean is popular during Christmas time. Indian Ocean is preferred mostly in autumn and Southern Ocean is a touristic attraction in Easter. Mediterranean Sea is also famous in winter time. Southern Ocean, which....., is also interesting with its beautiful beaches.

8. Clothes and jewellery have been the prime concern of our lives. In today's world, there are various fashion brands that are famous with different kind of clothes. In Dolce and Gabbana you may find modern skirts. Prada is popular with its trousers. In Armani, you can buy beautiful jackets and long dresses are sold in Mango. Valentino also produces elegant shirts. In Dolce and Gabbana, where....., prices are too high.

9. Do you know that you can suffer from a disease and not know it until you see a doctor? For example increased thirst is a sign of diabetes. Frequent urination signals high blood pressure. Weight loss may be an indicator of heart diseases. Bad vision may develop as a result of brain diseases and vertigo might be an indicator of obesity. Frequent urination, which....., might also be seen due to kidney problems.

10. The writer wrote about the kinds of best-seller books. According to this, one of these is the thriller novels with paperback. Crime novels with colourful cover are also preferred. Science fictions with blue covers and romance novels with balloons on their covers are popular too. Horror novels with animals on their covers are also included. Horror novels, which, are mostly sold in USA.

* Some chemicals are thought to hamper fertility in women. For example, detergents are believed to decline fertility hormones. Medicines can affect body functions negatively. Birth control pills can limit the egg production. Bad nutrients seem to decrease the quality of eggs. And stress also has a bad impact on women's reproductive organs. Birth control pills, which ..., are mostly used by young women.

* Here we list the foods that kill our intelligence. Sugary products are bad for our brain functions. Alcohol affects our ability to think clearly. Junk food may trigger anxiety while fried food destroy the nerve cells in the brain. Processed foods impact our central nervous system. Sugary products, which ..., are especially a danger for children. N-5

C. PASSAGES FOR FIGURES

1. The list of the busiest airports in Europe per year is announced. According to this list comes first the London Airport with 733 passengers. Second is the Paris Airport with 638 passengers. Frankfurt Airport is the third busiest airport with 596 passengers. 499 passengers visit Geneva Airport while 340 passengers visit Venice Airport. Frankfurt Airport, which....., was built last year.
2. The most powerful earthquakes recorded until today are included in today's paper. According to this paper, one of them was on 29th October 1923 in Chile. The earthquake in Alaska on 23rd April 1920 had also bad effects. Los Angeles earthquake was on 19th May June 1919 and San Francisco earthquake took place on 1st November 1922. Another powerful earthquake was in Manhattan on 10th November 1938. Chile earthquake, which, was the most devastating one.
3. The following table contains the languages with their estimated number of speakers. We can see that German is the most spoken language with 95 million native speakers. 70 million people speak Spanish as their native language and English is spoken by 66 million people. 49 million people speak French while Arabic is spoken by 32 million people. French, which....., is also spoken in other countries.
4. Like the rest of the world, Turkey is facing an increase of domestic violence. Statistics show that in May, there were approximately 400 cases and in July, that number had risen to 800. In October, 590 women were killed by a man and 620 women died because of man violence in November. Also, 330 women were killed in January. In July, when....., all cases were investigated by police.
5. HIV continues to kill people. In Africa, 13 people were killed by HIV while this number is 27 in Asia. 79 people died because of HIV in Europe. It killed 59 people in Antarctica and 44 people in America. In America, where....., no cure has still been found.
6. Health problems causing deaths of people were listed in the journal. Every year, 710 Americans have a heart attack and dies. 457 people die due to kidney diseases and 396 because of brain diseases. Cancer killed 220 people in America and 783 were dead due to muscular diseases. Heart attack, which....., stems from obesity.
7. The study claims that women prefer wearing different colours in the UK. 10, 1% of women like wearing green while 25, 4% of them prefer wearing red. 30, 6 % of women buy white outfits and 20, 9 % choose grey. Another 15, 7 % goes for orange. Grey, which....., is also the favourite colour of men.

8. Since Valentine's Day 48 inches of rain fell in Ankara. 12 inches rain fell in Niğde and 92 inches rain fell in Muş. In Antalya, 65 inches of rain was measured while it was 74 in Gaziantep. In Niğde, where....., the weather was mostly snowy.
9. Domestic goods manufactured in our country according to percentages are as follows: Motor vehicles are the most produced goods with 37, 4 % while white appliances have a percentage of 23, and 3 %. Another 20, 5 % covers textiles and 15, 8% includes technology products. Another sector is construction products with 5, 49 %. Textiles, which, include clothing and house ware.
10. Most expensive animals in pet shops are listed above. Kangaroos are being sold for \$17 while crocodiles worth \$38. Parrots cost \$57 and snakes are for \$29. Rabbits, on the other hand, are sold for \$44. Rabbits, which, are the favourites of children.

The number of sunny days lived in USA were recorded. According to data, there were 287 sunny days in Philadelphia and 964 sunny days in Washington. Toronto lived 785 days with sunshine while Californians saw the sun shining for 142 days. In Virginia the number of sunny days was 357. In California, where....., people are used to see rainy weather.

Different foods have different amount of calories. For example, white bread has 95 calories while Chinese food involves 60 calories. With a fruit yoghurt, you will take 32 calories and 71 calories with a sausage. Pop-corn has 49 calories. Chinese food, which....., is becoming popular among teenagers.

APPENDIX 2

A. PASSAGES FOR SEQUENTIAL EVENTS

1. The circulation of blood in the body is a complicated issue. First, your heart pumps blood from its left side into the arteries. Second, it travels through your arteries until it reaches every part of your body. Third, it travels back to the heart through your veins. Fourth, veins carry the blood to the right side of your heart. Fifth, your heart will pump the blood to your lungs with its next heartbeat. Stage 4, during which the, is extremely important because the blood is cleaned here.
2. There are different stages of sleep. In Stage 1 muscle activity slows. In stage 2, eye movement stops. When a person enters stage 3, extremely slow brain waves turn into smaller, faster waves. In stage 4, there is no eye movement or muscle activity. Fifth is the REM period when most dreams occur, However we should note that in stage 1, when,....., people may feel muscle contractions.
3. Each lunar phase can be identified by the appearance of the moon. First phase occurs when the moon is positioned between the earth and sun. Second phase is observed when the moon is on the opposite side of the earth. The third phase is when half of the moon is in shadow. In phase four, the moon is at a 90 degree angle with respect to the earth. Fifth phase is when the moon is illuminated. The third phase, when, is called the blue moon.
4. Today we share an easy cake recipe on the internet. The directions are as follows: First, whisk milk and sugar together in a bowl. Second, add butter into the bowl. Third, smash some bananas in another bowl. Fourth, add some chocolate into this mixture. Fifth, pour some orange juice into the bowl. Please note that during the second step, when you, you should remember to preheat the oven.
5. There are five layers in the Earth's atmosphere. The outermost layer contains low densities of hydrogen. The second layer is free of water vapour. The third layer is the coldest layer. Fourth layer is the lowest layer of Earth's atmosphere. Fifth layer is where all water vapour is found. I need to say that this fifth layer, where, is also called the final layer.
6. The inspector went to the power plant to check working conditions. He visited many departments in the plant. First, he had a look at the workplace to see if they have emergency kit. Second, he examined the air conditioning. Third, he walked to the bathroom to check lighting. Fourth, he evaluated the freshness of food in the kitchen. Fifth, he tested the fire alarms. At the fourth place, where he, he imposed a fine.

7. The teacher asked her students to write five reasons of why water is vital for us and the most popular answers were respectively as follows: First, it helps control calories. Second, it keeps muscles active. Third, it helps keep skin looking good. Fourth it controls blood pressure. And last, it provides oxygen for our body. The 2nd most popular answer, which, was given mostly by doctors.
 8. Human growth takes place in five stages. In the first stage, growth is very fast. During first stage, one is dependent on others for food and care. In the third stage, the person becomes independent. In fourth stage, there is mental development. Fifth stage is when there is no increase in height. At stage 3rd, when, person is called a “teenager”.
 9. Here is how plants make their food. First the roots absorb water from the soil. Second, the food-making process starts. Third, sunlight is combined with water. Fourth, photosynthesis takes place. Fifth, they throw out their waste. At the first step, when....., plants are green.
 10. There are descriptions of abilities to communicate in a language. At level 1, vocabulary is limited. At Level 2, individual can form simple sentences. At level 3 one is able to communicate. At Level 4, individual can understand complex sentences. At level 5, one can speak fluently. At level 5, when, one has also very good reading comprehension.
- People experience different stages of flue. In the 1st stage one will have weakness. In the 2nd stage increased thirst is seen and fever is observed in the 3rd stage. 4th stage is experienced when one has cough and 5th stage is when person needs to sleep constantly. In 3rd stage, when....., you should see a doctor.
 - It is a difficult job to make a strawberry pie. First, you need to mix flour and milk. Second, put the mixture on a tray. Third, smash strawberries. Fourth, add smashed strawberries on the mixture. Fifth, bake it in the oven. At the fourth step, when....., pre-heat the oven.

B. PASSAGES FOR LEXICAL ITEMS

1. A conference was held in our city last week. The Ambassador of England spoke about economy, the Undersecretary of Treasury about the global warming, the Minister of Finance about the industry, and the Mayor about fishery and the Minister of National Education about culture. The one who spoke about global warming,, was sitting next to the door.
2. There are certain foods that are on the most sold products list of countries. For example, cereals are the top products in Syria while dairy products are sold mostly in Slovenia. Red meat is the most popular choice in Denmark. Bakery products are number one in Portugal. Sea products are on the top in Bulgaria. Red meat, which....., is preferred because they are healthy.
3. People have different tastes of food in USA. According to a study, high-income families prefer eating canned food while low-income families are generally buying fresh fruits and vegetables. Teenagers often like to eat pasta and people over 60s are favouring light food. Additionally, middle-income families seem to like Mediterranean cuisine. People over 60s, who, also seem to like French fries.
4. People find various ways as means of livelihood. Stockbreeding, for example is a means of living in Europe. Transportation should be mentioned for a way of living in Africa. Fishery is observed in Antarctica while agriculture is seen in Asia and people make green housing in America. Stockbreeding which, usually takes place in the villages.
5. Animals in the Zoo are going to be transferred to different natural parks because of the reparation. Chickens are going to be carried to southern park and parrots will be transferred to the Northern farm. Elephants will go to the western Forest while snakes will be replaced in the Eastern barn. Bears will be accommodated in the northern natural park. Animals in the northern natural park which, will stay there for a month.
6. Rogers Construction Industry has begun its courses to address some issues. The courses will be presented by different instructors. Energy Management will be instructed by an engineer. Installation courses will be given by the deputy director. Water pollution course will be carried out by the Municipality. Renewable energy course will be given by a manager and business management by the head of the department. Especially for the water pollution Course, which....., is attendance obligatory.

7. According to the article in today's journal, tourists are visiting seas and oceans in different seasons. The Pacific Ocean is generally visited in April while Atlantic Ocean is popular during December. Indian Ocean is preferred mostly in February and Southern Ocean is a touristic attraction in March. Mediterranean Sea is also famous in November. Southern Ocean, which....., is also interesting with its beautiful beaches.
8. Clothes and jewellery are being sold with the names of celebrities. In today's world, there are various fashion brands of celebrities that are famous with their products. Lady Gaga has perfumes. Beyoncé is a brand of bags. In Victoria Beckham's stores, you can buy beautiful jewellery and clothes are sold with the brand of Jennifer Lopez. The brand of Taylor Swift also produces shoes. The brand of Lady Gaga, where....., prices are too high.
9. Do you know that you can suffer from a disease and not know it until you see a doctor? For example visual impairment is a sign of brain diseases. Forgetfulness signals hormonal diseases. Weight increase may be an indicator of internal diseases. Sleep disorder may develop as a result of heart diseases and high blood pressure might be an indicator of a tumour. Weight increase, which....., might also be seen due to kidney problems.
10. The writer wrote about the kinds of best-seller books. According to this, one of these is the encyclopaedias with paperback. E-books on popular websites are also preferred. Science fiction journals with CDs and comics with posters are popular too. Cookbooks with gifts are also included. Cookbooks, which, are mostly sold in England.

C. PASSAGES FOR FIGURES

1. The list of the busiest airports in Europe per year is announced. According to this list comes first the Geneva Airport with 684 passengers. Second is the Barcelona Airport with 430 passengers. Brussels is the third busiest airport with 925 passengers. 132 passengers visit Ankara Airport while 901 passengers visit Venice Airport. Brussels Airport, which....., was built last year.
2. The most powerful earthquakes recorded until today are included in today's paper. According to this paper, one of them was on 22nd February 1928 in Vietnam. The earthquake in India on 23rd November 1941 had also bad effects. Manhattan earthquake was on 17th May 1992 in Nepal an earthquake took place on 1st January 2005. Another powerful earthquake was in Tokyo on 10th March 2010. Vietnam earthquake, which, was the most devastating one.
3. The following table contains the languages with their estimated number of speakers. We can see that Spanish is the most spoken language with 89 million native speakers. 70 million people speak Japanese as their native language and Italian is spoken by 68 million people. 48 million people speak Chinese while Russian is spoken by 32 million people. Chinese, which....., is also spoken in other languages.
4. Like the rest of the world, Turkey is facing an increase of domestic violence. Statistics show that in October, there were approximately 550 cases and in December that number had risen to 700. In May, 530 women were killed by a man and 290 women died because of man violence in November. Also, 360 women were killed in February. In December, when....., all cases were investigated by police.
5. HIV continues to kill people. 19 people were killed in America by HIV while this number is 25 in Antarctica. 75 people died because of HIV in Europe. It killed 92 people in Asia and 67 people in Africa. In Africa, where....., no cure has still been found.
6. Health problems causing deaths of people were listed in the journal. Every year, 730 Americans have a heart attack and dies. 309 people die due to lung diseases and 420 because of muscular diseases. Cancer killed 280 people in America and 660 were dead due to bone diseases. Heart attack, which....., stems from obesity.
7. The study claims that women prefer wearing different colours in the UK. 15, 5% of women like wearing purple while 30, 6% of them prefer wearing white. 29.5 % of women buy black outfits and 22, 4 % choose yellow. Another 11.2 % goes for blue. Yellow, which....., is also the favourite colour of kids.

8. Since Valentine's Day 42 inches of rain fell in Maraş. 22 inches rain fell in Antep and 78 inches rain fell in Muğla. In Balıkesir, 59 inches of rain was measured while it was 40 in Mardin. In Antep, where....., the weather was mostly snowy.
9. Domestic goods manufactured in our country according to percentages are as follows: Electronic devices are the most produced goods with 32, 5 % while agricultural products have a percentage of 33, and 9 %. Another 22, 8 % covers kitchen utensils and 28, 2% includes textile products. Another sector is construction products with 50, 5 %. Kitchen utensils, which, are mostly bought by women.
10. Most expensive animals in pet shops are listed above. Cats are being sold for \$20 while dogs worth \$45. Birds cost \$34 and hamsters are for \$55. Horses, on the other hand, are sold for \$74. Horses, which, are the favourites of teenagers.
 - The number of sunny days lived in USA were recorded. According to data, there were 287 sunny days in Philadelphia and 964 sunny days in Washington. Toronto lived 785 days with sunshine while Californians saw the sun shining for 142 days. In Virginia the number of sunny days was 357. In California, where....., people are used to see rainy weather.
 - Different foods have different amount of calories. For example, white bread has 95 calories while Chinese food involves 60 calories. With a fruit yoghurt, you will take 32 calories and 71 calories with a sausage. Pop-corn has 49 calories. Chinese food, which....., is becoming popular among teenagers.

APPENDIX 3**QUESTIONNAIRE**

1. 2 ay boyunca uyguladığınız n-geri eğitiminin genel çeviri performansınızda bir artışa neden olduğunu düşünüyor musunuz?

- A. FARK GÖREMİYORUM
- B. FİKRİM YOK
- C. KESİNLİKLE DAHA İYİYİM.

2. 2 aylık “dual-n-back eğitimi” sonunda ANDAŞ ÇEVİRİ YAPARKEN ODAKLANMA VE UZUN SÜRELİ KONSANTRASYON SAĞLAMADA GELİŞME KAYDETTİĞİNİZE İNANIYOR MUSUNUZ?

- A. FARK GÖREMİYORUM
- B. FİKRİM YOK
- C. KESİNLİKLE DAHA İYİYİM.

3. 2 aylık “dual n-back eğitimi” sonunda ANDAŞ ÇEVİRİ YAPARKEN, KONUŞMACININ KONUŞMASI İLE ÇEVİRİNİZ ARASINDAKİ ZAMAN FARKINI DAHA İYİ VE DENGELİ ŞEKİLDE KAPATABİLDİĞİNİZE İNANIYOR MUSUNUZ?

- A. FARK GÖREMİYORUM
- B. FİKRİM YOK
- C. KESİNLİKLE DAHA İYİYİM.

4. 2 aylık “dual n-back eğitimi” sonunda ANDAŞ ÇEVİRİ YAPARKEN DAHA İYİ VE DOĞRU CÜMLE YAPILARI KURABİLDİĞİNİZİ DÜŞÜNÜYOR MUSUNUZ?

- A. FARK GÖREMİYORUM
- B. FİKRİM YOK
- C. KESİNLİKLE DAHA İYİYİM.

5. 2 aylık “dual n-back eğitimi” sonunda ANDAŞ ÇEVİRİ YAPARKEN BİLMEDİĞİNİZ BİR KELİMEYLE KARŞILAŞTIĞINIZ ZAMAN, BUNU DAHA

KOLAY BİR ŞEKİLDE TELAFİ EDEBİLDİĞİNİZE/ BU KONUDA DAHA HIZLI BİR ŞEKİLDE ÇÖZÜMLER ÜRETEBİLDİĞİNİZE İNANIYOR MUSUNUZ?

- A. FARK GÖREMİYORUM
- B. FİKRİM YOK
- C. KESİNLİKLE DAHA İYİYİM.

6. 2 aylık “dual n-back eğitimi” sonunda ÇEVİRİ DIŞINDA GÜNLÜK HAYATINIZIN BAŞKA ALANLARINDA (BİLİŞSEL OLARAK) TESPİT ETTİĞİNİZ İYİLEŞMELER OLDU MU? (AKILDAN YAPILAN HESAPLAMALARDA İYİLEŞME, BİR OYUNDA DAHA BAŞARILI OLMA, VB.)

- A. FARK GÖREMİYORUM
- B. FİKRİM YOK
- C. KESİNLİKLE OLDU

7. 2 aylık “dual n-back eğitimi” sonunda SAYILAR VE TARİHLER GİBİ RAKAMSAL VERİLERİ HATIRLAMADA DAHA İYİ OLDUĞUNUZU DÜŞÜNÜYOR MUSUNUZ?

- A. EVET
- B. FİKRİM YOK
- C. HAYIR

8. Oyun oynarken fiziksel olarak bir 1. İlk testteki performansınızla son testteki performansınızı karşılaştırdığınız zaman, şu anki genel çeviri performansınızı nasıl değerlendiriyorsunuz?

zorlanma hissettiniz mi?

- A. HİSSETMEDİM
- B. FİKRİM YOK
- C. KESİNLİKLE HİSSETTİM

9. Oyuna ilk başladığınız zaman kararlı bir şekilde oyuna devam etmekte güçlük çektiniz mi?

- A. EVET

B. FİKRİM YOK

C. HAYIR

10. Şöhret Koridoru sizi motive etmekte ve oyuna düzenli olarak devam etmenizde yararlı oldu mu?

A. EVET

B. FİKRİM YOK

C. HAYIR

11. Dual n-back eğitimi sonunda GÜN İÇİNDE YAŞADĞINIZ OLAYLARI HATIRLAMADA DAHA BAŞARLI OLDUĞUNUZU HİSETTİNİZ Mİ?

A.EVET

B. FİKRİM YOK

C. HAYIR

12. Dual n-back eğitimi sonunda OKUMA YAPARKEN ARTIK OKUDUĞUNUZU DAHA HIZLI VE VE KOLAY BİR ŞEKİLDE KAVRAYABİLDİĞİNİZE İNANIYOR MUSUNUZ?

A. EVET

B. FİKRİM YOK

C. HAYIR

13. Dual n-back eğitimi sonunda GÜRÜLTÜLÜ ORTAMLARDA DİKKATİNİZİ TEK NOKTADA TOPLAYIP YAPTIĞINIZ İŞE ODAKLANMADA DAHA BAŞARILI OLDUĞUNUZU DÜŞÜNÜYOR MUSUNUZ?

A. EVET

B. FİKRİM YOK

C. HAYIR

14. 2 aylık dual n-back eğitimi boyunca eğitimi hakkını vererek tamamladığınızı düşünüyor musunuz?

A. EVET

B. FİKRİM YOK

C. HAYIR

15. Arařtırma sreci sonrasında kendi kiřisel geliřiminiz iin dual n-back eđitimine devam etmeyi dřnyor musunuz?

A. EVET

B. FİKRİM YOK

C. HAYIR

APPENDIX 4

VOCABULARY LIST- PRETEST

Passage 1

Blood: Kan

Lungs: Akciğerler

Brain Cells: Beyin hücreleri

Muscles: Kaslar

Activate: Hareketlendirmek, harekete geçirmek

Stage: Aşama, safha

Passage 2

Wakefulness: Uyanıklık, uyanık olma durumu

Gradually: gittikçe, kademe kademe

Individual: Kişi

Less responsive: daha az duyarlı

Eyes roll: gözlerin yuvarlanması

Passage 3

Each lunar phase: Ayın her hali

Identify: tespit etmek, tanımak

Passage 4

Recipe: tarif

Whisk: çırpma

Strawberries: çilekler

Bowl: kase

Bake: pişirmek (fırında)

Preheated oven: önceden ısıtılmış fırın

Passage 5

Outmost layer: en dış tabaka

Denser: daha yoğun

Passage 6

Power plant: elektrik santrali

Inspector: müfettiş

Monitor: kontrol etmek, denetlemek

Air quality: Hava kalitesi

Workplace: çalışma alanı

Director: Müdür

Safety precautions: Güvenlik önlemleri

Threshold value: eşik değeri

Passage 7

Respectively: sırasıyla

Solar energy: güneş enerjisi

Recycling: Geri dönüşüm

Food chain: gıda zinciri

Passage 8

Human growth: insan gelişimi

Linguistic: dilsel

Passage 9

Trapped: hapsedmek

Nutrients: besin maddeleri

Waste: atık

Passage 10

Oral: Sözel

Demand: talep

Requirements: koşullar

Passage 1

Ambassador: Büyükelçi

Undersecretary: Müsteşar

Treasury: Hazine

Legislation: Yasama

Exportation: İhracat

Passage 2

Canned food: konserve gıda

Soft Drinks: Alkolsüz içecekler

Sweetened: Tatlandırılmış/ tatlandırıcıları

Passage 3

Cereal: Tahıl ürünleri

Passage 4

Livelihood: Geçim kaynağı
 Stockbreeding: Hayvancılık
 Pottery: Çömlekçilik

Passage 5

Reperation: Tamirat
 Barn: ahır

Passage 6

Vehicle operation: Araç işletme
 Environmental hazards: çevresel tehlikeler
 Director: Yönetici, müdür
 Inspector: müfettiş
 Attendance: Katılım, devamlılık

Passage 7

Indian Ocean: Hint Okyanusu

Passage 8

Fashion Brands: Moda markalar

Passage 9

Unrination: idrar yapma
 Blood pressure: kan basıncı
 Indicator: belirti, sinyal
 Kidney: böbrek

Passage 10

Thriller novels: gerilim romanları
 Paperback: karton kapak
 Crime: Polisiye roman
 Science Fiction: bilim kurgu
 Romance: aşk romanı

Passage 1

Geneva: Cenevre
 Venice: Venedik

Passage 2

Paper: Gazete
 Chile: Şili
 Devastating: tahrip edici/yok edici

Passage 3

Estimated: tahmini
 Native speaker: anadil konuşuru

Passage 4

Domestic violence: aile içi şiddet
 Approximatey: yaklaşık
 Investigated: Soruşturulmak

Passage 5

Cure: Tedavi, çare

Passage 6

Journal: dergi
 Muscular diseases: kas hastalıkları
 Stem from: kaynaklanmak

Passage 7

Outfit: kıyafet/ dış giysi

Passage 8

Valentine's Day: Sevgililer Günü

Passage 9

Domestic good: Yerli mal
 Motor vehicler: motorlu taşıt
 White appliances: beyaz eşyalar
 Textiles: tekstil ürünleri
 Construction products: inşaat ürünleri

Passage 10

Crocodile: timsah

APPENDIX 5

VOCABULARY LİST-POSTTEST

Passage 1

Blood: Kan
 Lungs: Akciğerler
 Brain Cells: Beyin hücreleri
 Muscles: Kaslar
 Activate: Hareketlendirmek, harekete geçirmek
 Stage: Aşama, safha

Passage 2

Wakefulness: Uyanıklık, uyanık olma durumu
 Gradually: gittikçe, kademe kademe
 Individual: Kişi
 Less responsive: daha az duyarlı
 Eyes roll: gözlerin yuvarlanması (sağ-sola hareket etme şeklinde)

Passage 3

Each lunar phase: Ayın her hali
 Identify: tespit etmek, tanımak

Passage 4

Recipe: tarif
 Whisk: çırpma
 Strawberries: çilekler
 Bowl: kase
 Bake: pişirmek (fırında)
 Preheated oven: önceden ısıtılmış fırın

Passage 5

Outmost layer: en dış tabaka
 Denser: daha yoğun

Passage 6

Power plant: elektrik santrali
 Inspector: müfettiş
 Monitor: kontrol etmek, denetlemek
 Air quality: Hava kalitesi
 Workplace: çalışma alanı
 Director: Müdür
 Safety precautions: Güvenlik önlemleri
 Threshold value: eşik değeri

Passage 7

Respectively: sırasıyla
 Solar energy: güneş enerjisi
 Recycling: Geri dönüşüm
 Food chain: gıda zinciri

Passage 8

Human growth: insan gelişimi
 Linguistic: dilsel

Passage 9

Trapped: hapsedmek
 Nutrients: besin maddeleri
 Waste: atık

Passage 10

Oral: Sözel
 Demand: talep
 Requirements: koşullar

Passage 1

Ambassador: Büyükelçi
 Undersecretary: Müsteşar
 Treasury: Hazine
 Legislation: Yasama
 Exportation: İhracat

Passage 2

Canned food: konserve gıda
 Soft Drinks: Alkolsüz içecekler
 Sweetened: Tatlandırılmış/ tatlandırıcı

Passage 3

Cereal: Tahıl ürünleri

Passage 4

Livelihood: Geçim kaynağı
 Stockbreeding: Hayvancılık
 Pottery: Çömlekçilik

Passage 5

Reperation: Tamirat

Barn: ahır

Passage 6

Vehicle operation: Araç işletme
Environmental hazards: çevresel tehlikeler
Director: Yönetici, müdür
Inspector: müfettiş
Attendance: Katılım, devamlılık

Passage 7

Indian Ocean: Hint Okyanusu

Passage 8

Fashion Brands: Moda markalar

Passage 9

Urination: idrar yapma
Blood pressure: kan basıncı
Indicator: belirti, sinyal
Kidney: böbrek

Passage 10

Thriller novels: gerilim romanları
Paperback: karton kapak
Crime: Polisiye roman
Science Fiction: bilim kurgu
Romance: aşk romanı

Passage 1

Geneva: Cenevre
Venice: Venedik

Passage 2

Paper: Gazete
Chile: Şili
Devastating: tahrip edici/yok edici

Passage 3

Estimated: tahmini
Native speaker: anadil konuşuru

Passage 4

Domestic violence: aile içi şiddet
Approximatey: yaklaşık

Investigated: Soruşturulmak

Passage 5

Cure: Tedavi, çare

Passage 6

Journal: dergi
Muscular diseases: kas hastalıkları
Stem from: kaynaklanmak

Passage 7

Outfit: kıyafet/ dış giysi

Passage 8

Valentine's Day: Sevgililer Günü

Passage 9



Domestic good: Yerli mal
Motor vehicler: motorlu taşıt
White appliances: beyaz eşyalar
Textiles: tekstil ürünleri
Construction products: inşaat ürünleri

Passage 10

Crocodile: timsah

APPENDIX 6

ETHICS BOARD WAIVER FORM FOR THESIS WORK

	HACETTEPE UNIVERSITY GRADUATE SCHOOL OF SOCIAL SCIENCES ETHICS BOARD WAIVER FORM FOR THESIS WORK
HACETTEPE UNIVERSITY GRADUATE SCHOOL OF SOCIAL SCIENCES TRANSLATION & INTERPRETATION TO THE DEPARTMENT PRESIDENCY	
Date: 18/01/2016	
Thesis Title / Topic: <u>EFFECT OF WORKING MEMORY TRAINING ON</u> <u>SIMULTANEOUS INTERPRETATION PERFORMANCE: DUAL N-BACK TASK</u>	
My thesis work related to the title/topic above: <ol style="list-style-type: none"> 1. Does not perform experimentation on animals or people. 2. Does not necessitate the use of biological material (blood, urine, biological fluids and samples, etc.). 3. Does not involve any interference of the body's integrity. 4. Is not based on observational and descriptive research (survey, measures/scales, data scanning, system-model development). 	
I declare, I have carefully read Hacettepe University's Ethics Regulations and the Commission's Guidelines, and in order to proceed with my thesis according to these regulations I do not have to get permission from the Ethics Board for anything; in any infringement of the regulations I accept all legal responsibility and I declare that all the information I have provided is true.	
I respectfully submit this for approval.	
Date and Signature: 18/01/2016	
Name Surname: <u>Buse Sakallı</u> Student No: <u>112227570</u> Department: <u>TRANSLATION & INTERPRETATION</u> Program: <u>TRANSLATION & INTERPRETATION (ENGLISH)</u> Status: <input checked="" type="checkbox"/> Masters <input type="checkbox"/> Ph.D. <input type="checkbox"/> Integrated Ph.D.	
ADVISER COMMENTS AND APPROVAL	
Approved  <u>Prof. Dr. Aymin Döğen</u> (Title, Name Surname, Signature)	

APPENDIX 7

TEHSIS/DISSERTATION ORIGINALITY REPORT

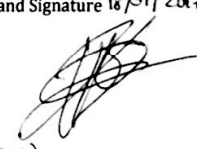
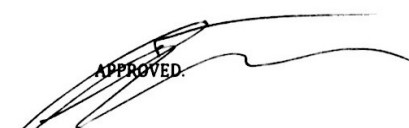
	HACETTEPE UNIVERSITY GRADUATE SCHOOL OF SOCIAL SCIENCES THESIS/DISSERTATION ORIGINALITY REPORT
HACETTEPE UNIVERSITY GRADUATE SCHOOL OF SOCIAL SCIENCES TO THE DEPARTMENT OF TRANSLATION & INTERPRETATION	
Date: 18/01/2016	
Thesis Title / Topic: <u>EFFECT OF WORKING MEMORY TRAINING ON</u> <u>SIMULTANEOUS INTERPRETATION PERFORMANCE: DUAL N-BACK TASK</u>	
According to the originality report obtained by myself/my thesis advisor by using the Turnitin plagiarism detection software and by applying the filtering options stated below on 5.2.2016 for the total of <u>131</u> pages including the a) Title Page, b) Introduction, c) Main Chapters, and d) Conclusion sections of my thesis entitled as above, the similarity index of my thesis is <u>11</u> %.	
Filtering options applied: <ol style="list-style-type: none"> 1. Approval and Declaration sections excluded 2. Bibliography/Works Cited excluded 3. Quotes excluded 4. Match size up to 5 words excluded 	
I declare that I have carefully read Hacettepe University Graduate School of Social Sciences Guidelines for Obtaining and Using Thesis Originality Reports; that according to the maximum similarity index values specified in the Guidelines, my thesis does not include any form of plagiarism; that in any future detection of possible infringement of the regulations I accept all legal responsibility; and that all the information I have provided is correct to the best of my knowledge.	
I respectfully submit this for approval.	
Date and Signature 18/01/2016	
Name Surname: <u>Buse Sakall</u> Student No: <u>112227570</u> Department: <u>TRANSLATION & INTERPRETATION</u> Program: <u>TRANSLATION & INTERPRETATION (ENGLISH)</u> Status: <input checked="" type="checkbox"/> Masters <input type="checkbox"/> Ph.D. <input type="checkbox"/> Integrated Ph.D.	
ADVISOR APPROVAL	
 APPROVED.	
<u>Prof. Dr. Aymil Döğen</u> (Title, Name Surname, Signature)	

