



Bulletin of the Mineral Research and Exploration

<http://bulletin.mta.gov.tr>



Evaluation of the alternatives for gold ore grinding circuits by using of laboratory studies results and simulation method; case study: Iranian Gold Co.

Hojjat HOSSEINZADEH GHAREHGHEHLAGH^{a*}, Ayşe Tuğba CEBECİ^b and Şevket Levent ERGÜN^c

^aDepartment of Mining Engineering, Urmia University of Technology (UUT), Band road, Urmia, West Azerbaijan, Iran. orcid.org/0000-0002-7763-9596

^bDepartment of Mining Engineering, Hacettepe University, Beytepe 06532, Ankara, Turkey. orcid.org/0000-0002-7763-9596

^cDepartment of Mining Engineering, Hacettepe University, Beytepe 06532, Ankara, Turkey. orcid.org/0000-0002-6500-7540

Research Article

Keywords:

Comminution / Grinding circuit, Modeling and Simulation, JKSimMet, Gold ore, Clayey Minerals.

ABSTRACT

In this study, simulation aided design of grinding circuit for a gold mine in Iran is presented. The main parameters for the design of the grinding circuit are the ore specifications and the considered operating conditions. Ore specifications were characterized by grinding tests, which included the Drop - weigh test (A, b), the abrasion test (t_a) and the Bond Work Index test (W_i). For this study, the operating conditions for the processing plant are the ability to process clayey minerals and the plant throughput and the d_{80} of the hydrocyclone overflow (leaching tank feed), which are 125 tons per hour and 45 μm , respectively. Simulation operations were performed using grinding parameters (A, b, t_a , W_i), operating constraints (plant capacity, d_{80} of the hydrocyclone overflow and ability to work for clayey minerals), existing mathematical models for different types of crushers, mills and separators and JKSimMet software. By completing the simulation process, three different alternatives for the grinding circuit of the considered ore were predicted. These three alternatives have been compared and evaluated with each other in terms of specific energy consumption (kWh/t), sensitivity to operational variables and the ability to process clayey minerals. The optimal circuit must have the capability to process clayey minerals and must have the lowest specific energy consumption and the least sensitivity to operational variables. By considering all these factors, the Alternative 3 is selected and suggested for an efficient grinding circuit.

Received Date: 21.04.2018

Accepted Date: 17.09.2018

1. Introduction

There are different methods for design, optimization and control of a mineral processing system which all of them based on the computer evolutionary programs and simulation software. On the other hand, the foundation of these computer programs and simulation software is the mathematical models defined for the various equipment used in the system. In this case, the more accurate the mathematical models, the results will be so accurate (King et al., 2012).

When designing a processing plant, in summary, two main parameters determine the type of equipment and their capacity. The first parameter is the amount of production or plant capacity (described as tons per hour or tph) with the optimal efficiency (metallurgical and economic). The second parameter is the ability to maneuver against the unpredicted changes occurring in the properties of the ore and operating conditions (Mular et al., 2002).

The capacity of a processing plant depends on many parameters including mine capacity (number

Citation Info: Hosseinzadeh Gharegheshlagh, H., Cebeci, A. T., Ergün, Ş. L. 2019. Evaluation of the alternatives for gold ore grinding circuits by using of laboratory studies results and simulation method; case study: Iranian Gold Co. Bulletin of Mineral Research and Exploration, 159, 219-233. <http://dx.doi.org/10.19111/bulletinofmre.501432>

* Corresponding author: Hojjat HOSSEINZADEH GHAREHGHEHLAGH, h.hoseynzade@uut.ac.ir

of bench faces or working benches), required capital, type and number of equipment, economic conditions and the price of ore and metals and etc (Mular et al., 2002).

Despite the complexities of defining the optimization criteria and the optimum operating conditions of a processing plant, these parameters have been extensively discussed by Kelly and Spottiswood (1982), Kelly (1991). Generally, the optimum efficiency of a plant depends on the characteristics of the ore and the type and efficiency of the equipments. To achieve optimal efficiency, prior to the design phase, enrichment operations with laboratory devices are performed on the separated size fractions of the ore samples (the type of laboratory equipment should be in line with the type predicted in the industrial process). Each size fraction which has the optimal state for metallurgical and economic efficiency will be considered as an optimal size for industrial concentration plant feed (Depending on the economic conditions, optimal efficiency can be considered as metallurgical efficiency or economic efficiency).

The operational efficiency of the processing plant will be fully affected by the working conditions of the equipment and ore specifications such as grade, texture, physical, chemical and mechanical properties, gang type and clay minerals. Clay minerals are one of the biggest problems in the processing plants, which has a negative effect on the grinding efficiency, enrichment and dewatering systems, and reduces overall plant efficiency (Wills and Napier-Munn, 2011). Due to the nature of mining, these ore properties will fluctuate in different parts of the mine. Therefore, in the absence of prediction of possible changes in the ore properties during the design phase of a plant, the plant will be disrupted and will not achieve to the optimal efficiency in the operational phase and in some cases the plant may come inoperable.

Comminution (crushing and milling) is the most important part of a mineral processing plant whose task is to liberate valuable minerals or metals from the gang (for metallic minerals) or to reach a certain finesse size (for industrial minerals). On the other hand, the optimal design of a comminution system is important in terms of reducing investment and operational costs in the a mineral processing plant, related to the fact that the comminution systems account for about 60% of investment costs, 40 to 50% operating costs and more than 60% of energy costs

(Wenzheng, 1991). In some cases, only milling part will account for about 90% of operating costs (Wills and Napier-Munn, 2011).

The aim of this work is to design an optimal crushing circuit for a gold processing plant in Iran that will work with a clayey ore with a specific gravity of $2,70 \text{ gr / cm}^3$. The main parameters for the design of the comminution circuit are the ore specifications and the considered operating conditions. Ore specifications were characterized by grinding tests, which included the Drop -weigh test (A, b), the abrasion test (ta) and the Bond Work Index test (Wi). For this Project, the operating conditions for the processing plant are the plant capacity and the size of the hydrocyclone overflow (the hydrocyclone overflow is fed to the leaching tank, so, the size of the hydrocyclone overflow is equal to the leaching tank feed), which are 125 tons per hour (tph) and 45 microns, respectively. The size of the hydrocyclone overflow (leaching tank feed) is shown using the parameter d_{80} (80% passing size) which has been obtained using previous laboratory studies on the separated size fractions of the ore samples. The results show that the best efficiency of the processing plant will be when the d_{80} of the hydrocyclone overflow (leaching tank feed) is $45 \mu\text{m}$.

Furthermore, one of the most important parameters affecting the operation stage is the presence or absence of clay minerals in the ore (Wills and Napier-Munn, 2011). Therefore, in the design phase of the processing plant, the dimensions and type of equipment and their arrangement depend on the properties of the ore, material flowrate, the amount of grinding and the ability to work for clay minerals (Mular et al., 2002). Furthermore, if there are several different systems for the desired purpose, each system that is able to meet the desired criteria with the lowest cost is preferred.

Using the above conditions, simulation operations were performed using grinding parameters (A, b, ta, Wi), operating constraints (plant capacity=125 tph, $d_{80}=45\mu\text{m}$ and ability to work for clayey minerals), JKSimMet software and existing mathematical models for different types of crushers, mills and separators.

By completing the simulation process, three different alternatives for the comminution circuit of the considered ore were predicted. Finally, these three alternatives have been compared with each other and then the appropriate and optimal circuit was chosen.

1.1. Modeling and Simulation in the Mineral Processing

For a complete description of a processing plant or a comminution circuit it is needed to define the models and simulation method of these models.

Simulation is an imitation of a real process or system in a virtual environment (Banks et al., 2001), which using it, it is possible to see the response or set of responses of a system or a process to changes made, without doing a real activity on a system or process. By using these observations, it is also possible to decide whether or not to make the necessary changes in reality (Gray and Rumpe, 2016).

To perform a simulation operation, there is a need for mathematical equations describing the behavior of the components and the entire system, which are called the mathematical models (Sokolowski and Banks, 2009). These models represent the principal properties, behaviors and functions of the selected system. In fact, the model symbolized the system itself, while the simulation describes the operation of the system over time (Gray and Rumpe, 2016).

In the mineral processing industry, the tendency to predict the results of changes in the operational and/or design parameters have always been of interest to the researchers. To have a precise and accurate prediction, it is important to know the behavior of that system and the parameters that affect the objective function (Robinson, 1997).

The first mathematical based models in the mineral processing industry were presented in 1933 for modeling the size distribution of materials (Rosin and Rammler, 1933). Epstein (1947; 1948) obtained the breakage and selection functions for mills by using the mass balance model. Then, new models for flotation kinetics (Sutherland, 1948), grindability and Energy – size reduction (Bond, 1952), reduced efficiency curve for cyclone separators (Yoshioka and Hotta, 1955), matrix equations involving breakage, selection and classification functions (Broadbent and Callcott, 1956; Lynch, 1977), kinetic models (Broadbent and Callcott, 1956; Gardner and Austin, 1962; Kelsall and Reid, 1969; Whiten, 1971; Herbst and Fuerstenau, 1980; Austin et al., 1984) and energy balance models (Napier-Munn et al., 1996) were introduced.

Later, by combining simple models and forming complex models, it was possible to study the behavior

of various systems such as mills, classifiers, and so on. For example, Whiten (1974) presented a new model called the Perfect Mixing Model by combining the obtained mathematical models (breakage and selection functions, discharge rate and feed and product size distributions of the mill) and the mass balance principle. With the advancement of computer science and the ability to analyze, solve and interpret complex problems with computers, a combination of simple and complex mathematical models in the form of a simulator package was used to predict the desired target functions. Thus, it was possible to use simulations to analyze simple and complex circuits of ore processing systems.

1.2. JKSimMet Software

To simulate a system, one or more models are needed for each of the components of the system and the associated models of these components. The integration of mathematical models of all components forming a comminution system in a simulation package provides the necessary facilities for studying the whole system, the individual components and the interaction of components on each other (such as the effect of the mill efficiency on the hydrocyclone).

In the mineral processing industry, various simulators have been developed to carry out the necessary studies. The JKSimMet software, used in this study, is the most widely used and most reliable simulation software in comminution circuits of the mineral processing plants. This software uses the best math models obtained for various components of the comminution circuit (different types of crushers, mills and separators) and data from hundreds of different processing plants to perform various operations such as mass balance, design, optimization, calibration and comparison of different conditions in a comminution circuit and comparing conditions in different comminution circuits. The initial version of this software was presented in 1980 by Julius Kruttschnitt Mineral Research Centre (JKMRC) and the first commercial edition of JKSimMet was also introduced in 1986, when JKTech, the JKMRC commercial branch, was founded.

As noted, the existence of accurate and validated models and extensive industrial data-base has led to the increasing use of JKSimMet software by various researchers. This software was used in the many comminution plants and joint industry-university

research projects such as Morrell et al. (1996), Hart et al. (2001), Dunne et al. (2001), Nikkiah and Anderson (2001), Ergun et al. (2005), Delboni et al. (2006), Munoz et al. (2008), Pellegrini Rosario (2010), Schwarz and Richardson (2013), Hosseinzadeh Gharehgheshlagh (2014), Shi et al. (2015), Zuo (2015), Maruf Hasan (2016), Tavares and Delboni (2016), Liang et al. (2016), Koch (2017), Palaniandy (2017), Hosseinzadeh Gharehgheshlagh et al. (2017), Wendelin Wikedzi (2018) and etc. Some important models of this software can be summarized as table 1.

Table 1- Important models of the JKSimMet software.

Equipment Models	Researchers
Crushers (Jaw, Gyratory, Cone, Roll and VSI (Vertical Shaft Impact Crusher) Moels	Awachie (1983); Whiten (1984); Andersen (1989)
High Pressure Grinding Rolls (HPGR) Models	Tondo (1996); Morrell et al. (1997); Daniel (2002); Daniel and Morrell (2004)
Ball Mill Model	Whiten (1972; 1976); Lynch (1977); Morrell (1992)
Rod Mill Model	Lynch (1977)
Autogeneous (AG) and Semi-autogeneous (SAG) mills Models	Leung (1987); Leung et al. (1987)
Hydrocyclone Models	Lynch and Rao (1975); Nageswararao (1978)
Breakage Distribution Function (BDF) models	Narayanan and Whiten (1983); Narayanan (1985)
AG and SAG mills and Ball Mill Power Models	Morrell and Morrison (1989); Morrell (1992; 1993; 1996); Morrell et al.(1992)

2. Experimental Studies

Design of grinding circuit for Iranian Gold Co. is carried out in the Mining Engineering department of the Hacettepe University in Turkey. The required feed rate and d_{80} of hydrocyclone overflow were 125 tph and 45 μm , respectively. The JKSimMet software that developed in Julius Kruttschnitt Mineral Research Center (JKMRC) is used for simulations (Napier-Munn et al., 1996).

The experimental studies are divided into two sections; the laboratory works and the simulation process.

2.1. Laboratory Works

In order to use the JKSimMet simulation software, the required parameters for characterizing of Run Of

Mine (ROM) ore must be determined via laboratory works. These parameters, for grinding circuit, are the Breakage Distribution Function (BDF) or the Appearance function, the Bond Work Index (BWI) and the Abrasion Index.

2.1.1. Brekage Test

The BDF is one of the important parameters of grinding circuits that is used for design, operation, modeling, simulation and optimization of these circuits. There are different methods to calculate BDF; Batch Grinding test in laboratory mills, Back Calculation methods and Single Particle Breakage under controlled conditions. The Single Particle Breakage under controlled conditions is divided into three methods including Impact test, Slow Compression test and Abrasion test. The Impact methods divide to Single Impact tests and Double Impact tests. Finally, the Double Impact tests divide into four groups including Twin Pendulum tests, Drop Weight tests, Hopkinson Pressure Bar and Ultra-Fast Load Cell tests.

In this study, the Drop Weight Test (DWT) is used for determination of the BDF or impact breakage characteristics of the ore. This method has started since 1938 by Gross (1938). Then, many researches such as Piret (1953), Arbiter (1969), Narayanan and Whiten (1983), Narayanan (1985), Leung (1987), Tavares (1999), Man (2001), Genç et al. (2004), Genç and Benzer (2008), Özer and Whiten (2012) and etc. used this method with different materials, apparatuses and conditions. A new apparatus for the Drop Weight method developed by Narayanan (1985) in the JKMRC is the simplest and most commonly used method for investigation of impact breakage characteristics of materials. A type of this device is used in this study has been given in figure 1.

BDF Determination: There are different approaches to calculate the BDF of materials and represent it mathematically. Leung (1987) gave the following relationship between the specific comminution energy and t_{10} parameter.

$$t_{10} = A \times (1 - e^{(-E_{cs} \times b)}) \quad (1)$$

Where, t_{10} is the impact breakage distribution parameter or breakage index or fineness index which quantifies the amount of material passing 1/10's of the original size, here; geometric mean of the tested size range is known as individual size, is used to

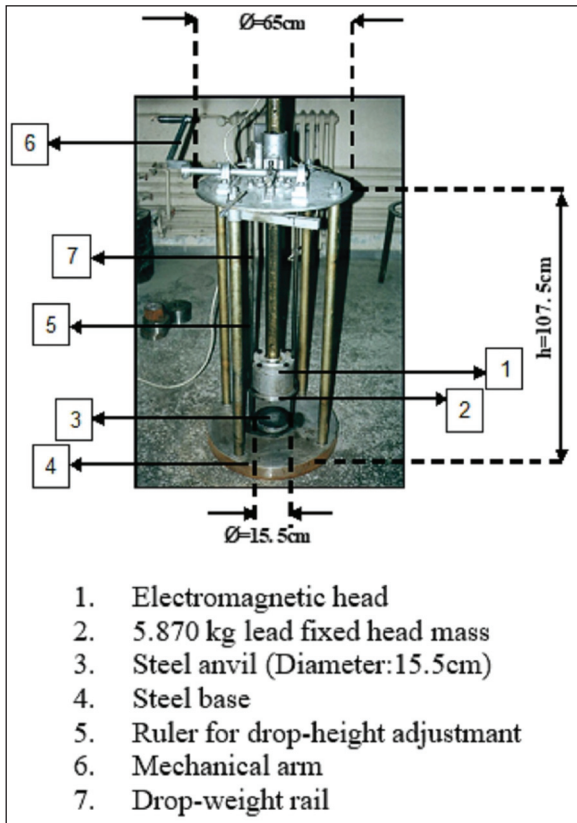

Figure 1- DWT apparatus of Hacettepe University (Genç and Benzer, 2008)

represent the degree of size reduction. E_{cs} is the specific comminution energy (kWh/t) and A and b are impact breakage parameters. The maximum limit of t_{10} is defined as A, and the slope of the straight portion of the t_{10} versus E_{cs} plot gives the value of b. The value

of A.b represents the ease of impact breakage in which larger values indicating more breakage occurring for a given energy input (Napier-Munn et al., 1996). Narayanan and Whiten (1983) base the proposed equation of Leung (1987) and calculated normalized breakage distribution function using the approach of t-family curves.

Sample Preparation And Breakage Procedure: To determine BDF, the JKMR standard is used. In this standard 5 different size fractions with 3 different specific comminution energies for each size fraction are selected, table 2, and with each specific comminution energy 20 particles are breakage. For this purpose, the DWT apparatus of the Hacettepe University (Figure 1) is used.

Table 2- Size intervals and nominal input energy levels (kWh/t) used in JKMR AG/SAG drop weight test.

test	Size interval, mm				
	-63 +53	-45 +37,5	-31,5 + 26,5	-22,4 + 19	-16 +13,2
1	0,10	0,10	0,25	0,25	0,25
2	0,25	0,25	1,00	1,00	1,00
3	0,50	0,50	2,50	2,50	2,50
Specific energy, kWh/t					

E_{cs} - t_{10} Model: After the breakage tests, sieve analysis of broken material is obtained for each energy level. Assuming that the geometric mean of each fraction is its initial size, cumulative percent passing of materials is obtained from 1/2, 1/4, 1/10, 1/25, 1/50 and 1/75 of this size that is shown by t_2 , t_4 , t_{10} , t_{25} , t_{50} and t_{75} respectively (Table 3). Using the equation proposed by Leung and obtained t_{10} values, specific comminution

Table 3- E_{cs} - t_{10} - t_n amounts after breakage.

Fraction mm	Ec kWh/t	t_n , %					
		t_{10}	t_2	t_4	t_{25}	t_{50}	t_{75}
-16+13.2	0,75	46,0	96,5	77,5	29,0	20,0	16,5
	1,00	69,0	100	94,5	50,0	39,0	32,5
	2,50	66,0	100	94,0	45,5	34,0	30,5
-22.4+19	0,25	29,5	93,5	51,0	19,0	14,5	12,5
	1,00	46,0	100	78,0	30,0	22,5	19,0
	2,50	57,0	97,5	86,0	41,5	34,0	30,5
-31.5+26.5	0,25	31,0	79,5	52,0	20,5	15,0	13,0
	1,00	47,5	96,5	74,5	29,0	20,0	16,0
	1,60	54,0	100	88,0	34,0	24,5	21,0
-45+38	0,10	9,5	38,5	19,0	6,5	4,5	4,0
	0,20	24,5	79,5	43,0	14,5	10,5	9,0
	0,40	29,0	88,5	54,5	17,0	12,5	11,0
-63+55	0,10	17,0	55,5	31,5	10,0	7,0	6,0
	0,15	18,5	71,5	37,0	10,0	7,0	5,5
	0,20	31,5	89,0	51,5	19,0	15,0	12,5

energy plotted versus t_{10} (Figure 2). Results show that A and b values for this ore are 59.11 and 2.41 respectively.

t-family Curve: To obtain t-family curve, t_{10} values measured to each specific comminution energy level put as a basis. Then on coordinate axis that X-axis shows t_{10} 's and the Y-axis shows corresponding t_n 's, a graph will be plotted in which all of the t_2, t_4, \dots, t_{75} 's will connect to each other with best trend lines. The total set of these lines is called t-family curve (Figure 3).

Calculation of BDF Matrix Arrays from T-Family Curve: To obtain BDF, assuming that the largest mill feed size is 36 mm, a lower triangular square matrix

is formed that its largest size is 36 and its under dimensions are the square root of the previous one (the largest size of the matrix corresponds with the biggest size of the mill feed. In this matrix the row number shows the particle sizes, the first row shows the biggest particle and the others show the fine sizes). Firstly, t_{10} value is calculated by using equation 1 and arbitrary specific comminution energy (here, $E_{cs} = 1$ kWh/t). Secondly, using t-family curves t_n 's values ($n= 2, 4, 25, 50, 75$) are calculated and a unique particle size distribution is formed (to calculate the breakage function for values smaller than Y_{75} , the extrapolation of the last three values is used). Then, using this distribution, the cumulative percent passing values are obtained for all sizes in the matrix. Finally, Using this data, the amount remaining on each size is calculated

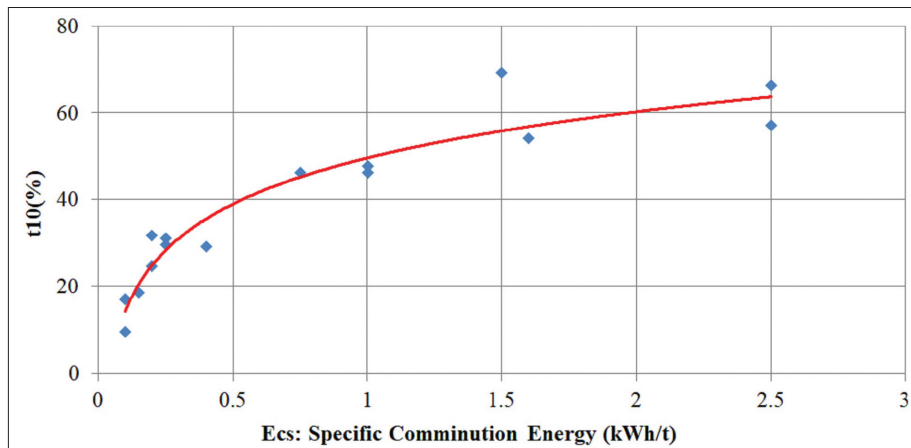

Figure 2- E_{cs} - t_{10} relationship.

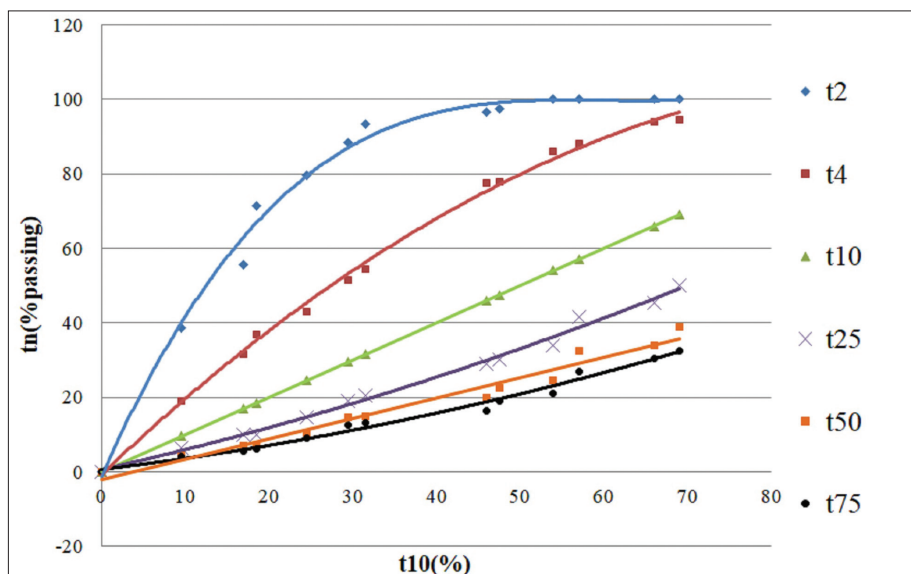

Figure 3- t-family curve.

as a fraction. This data gives the first column of the breakage distribution matrix and called the BDF. The other columns are formed by the downward movement of the previous columns.

2.1.2. Bond Test

The work index is the comminution parameter which expresses the resistance of the material to crushing and grinding; numerically it is the kilowatt hours per ton required to reduce the material from theoretically infinite feed size to 80% passing 100 μm (Bond, 1952). The Bond standard grindability test has been performed in 30.5 - 30.5 cm in diameter and length standard laboratory ball mill that has been described in detail by Deister (1987) and Levin (1989). The Bond equation for calculating W_i value is as below (Bond, 1961):

$$W_i = \frac{48.95}{D^{0.23} G_{bp}^{0.82} \left(\frac{10}{\sqrt{P_{80}}} - \frac{10}{\sqrt{F_{80}}} \right)} \quad (2)$$

Where;

W_i : Work Index (kWh/t)

D: Control sieve size (106 μm)

G_{bp} : Grindability factor (g/rev)

P_{80} : 80% passing size of the final product (μm)

F_{80} : 80% passing size of the mill feed, before grinding, (μm)

Calculation of the work index for this sample was also performed using kinetic grinding test (Gharehgheshlagh, 2016). As a result of the Bond and the kinetic grinding tests performed on Iranian Gold Co. ore W_i value of the ore was determined as 9.20 kWh/t in both methods.

2.1.3. Abrasion Test

For the determination of abrasion parameters a tumbling drum which has 300 mm both in diameter and length is used. There are four 10 mm lifters in the

drum. A 3 kg sample of -55+38 mm ore is ground for 10 minutes at 70% critical speed (53 revolution per minute) (Napier-Munn et al., 1996). t_a is the 1/10th of t_{10} value. The t_a value of Iranian Gold Co. ore is 1.70.

2.1.4. Ore Density Test

The density test for Iranian Gold ore sample carried out by using pycnometer and distilled water. The ρ_s value is obtained as 2,7 gr/cm³.

2.1.5. Results of Laboratory Studies

Impact breakage characteristics of the ore were measured by the drop weight tester. Abrasion characteristic was determined by tumbling drum test. Ball mill grindability of the ore was determined by standard Bond's test. The specific gravity of the ore was found to be 2,70 gr/cm³ by using density bottle tests.

The ore specifications determined in experimental studies are given in table 4.

Table 4- Grinding parameters determined for Iranian Gold Co. Ore.

Parameter	Value
A (%)	59,11
B (kWh/t%)	2,41
t_a (%)	1,70
BWI (kWh/t)	9,20
ρ_s (gr/cm ³)	2,70

By considering A, b, t_a and W_i parameters, the ore hardness can be characterized according to the table 5.

2.2. Simulation Studies

After determination of the ore parameters, the simulation procedure can be performed with the JKSimmet software.

Table 5 – JKTech ore characterization by considering A, b, t_a and W_i parameters (JK Drop Weight Test and JK Bond Ball Mill Index Test).

Property	Very Hard	Hard	Medium	Soft	Very Soft
A*b	< 30	30 - 38	43 - 56	67 - 127	> 127
t_a	< 0.24	0,24 - 0,35	0,41 - 0,54	0,65 - 1,38	> 1,38
W_i (kWh/t)	> 20	14 - 20	9 - 14	7 - 9	< 7

Simulation operations were performed using grinding parameters (A, b, ta, Wi), operating constraints (plant capacity = 125 tph, d_{80} of the hydrocyclone overflow (leaching tank feed) = 45 μ m and ability to work for clayey minerals), JKSimMet software and existing mathematical models for different types of crushers, mills and separators.

By completing the simulation process, three different alternatives for the comminution circuit of the considered ore were predicted.

These three different alternative circuits were as below:

- Alternative 1: SAG Mill/Closed Circuit Ball Mill.
- Alternative 2: Open Circuit Coarse Ball Mill and Closed Circuit Fine Grinding Ball Mill.
- Alternative 3: Closed Circuit Coarse Ball Mill and Closed Circuit Fine Grinding Ball Mill.

Firstly, these three alternatives compared with each other in terms of specific energy consumption (kW/t), sensitivity to operational variables and the ability to process clayey minerals. Then, the appropriate and optimal circuit was selected. The optimal circuit

should have the capability to process clayey minerals and has the lowest energy consumption per unit weight of ore and the least sensitivity to operational variables.

2.2.1. SAG Mill/Closed Circuit Ball Mill

The total energy consumption of this alternative will be 3977 kW. In this alternative ROM ore will be crushed by a jaw crusher. The crushed material will be stockpiled. A SAG mill having 7 m inside diameter and 2.5 m inside length will be used. This SAG mill will work with 31.11% volumetric total load and 1550 kW gross power. The SAG mill discharge will be fed to a vibrating screen having 13 mm aperture. The aim of this screen is to protect the pump from coarse material. Screen oversize will be sent to the SAG mill while undersize will be sent to the cyclone feed sump. 0.8x375 mm cyclones will be used to separate fine material. The cyclone underflow will be fed to a ball mill having 4.5 m inside diameter and 6 m inside length. This mill will work with 35% volumetric total load and 2000 kW mill power. Ball mill discharge will be fed to the cyclone feed sump. The cyclone overflow will be the final product. The simplified flowsheet and mass balance of the Alternative 1 is given in figure 4 and the simulated size distribution of the streams around the circuit is shown in figure 5.

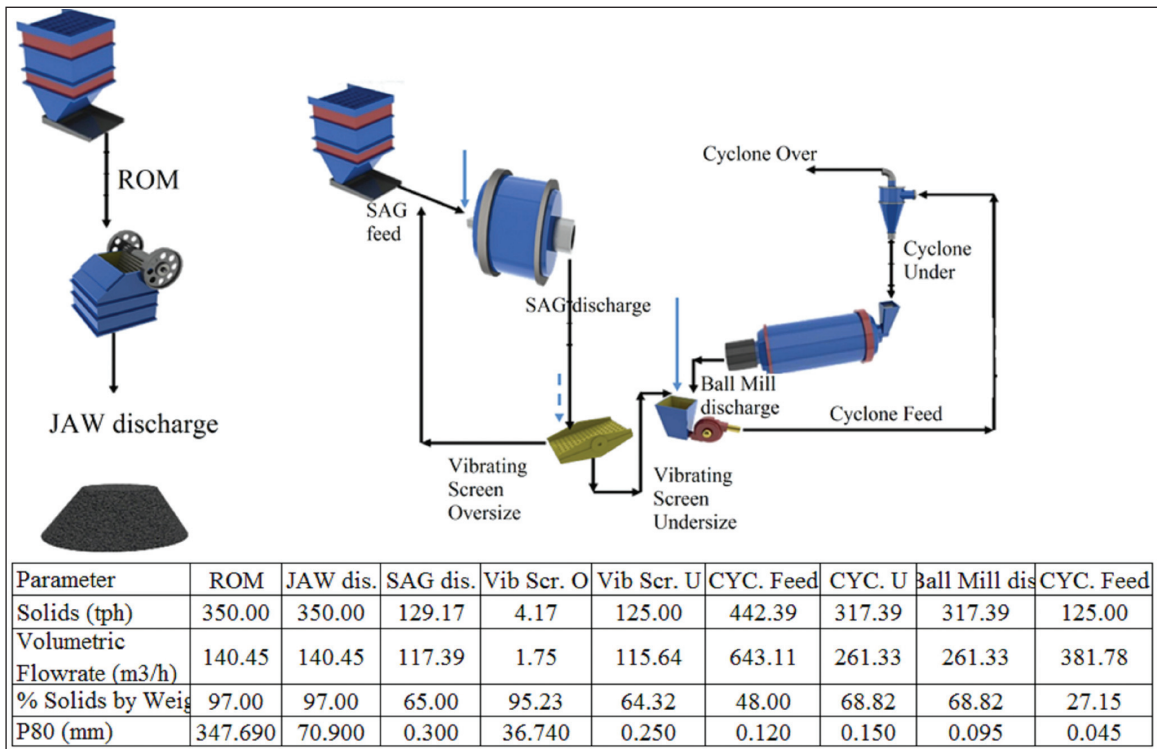

Figure 4- Simplified Flowsheet and Mass Balance of Alternative Circuit 1.

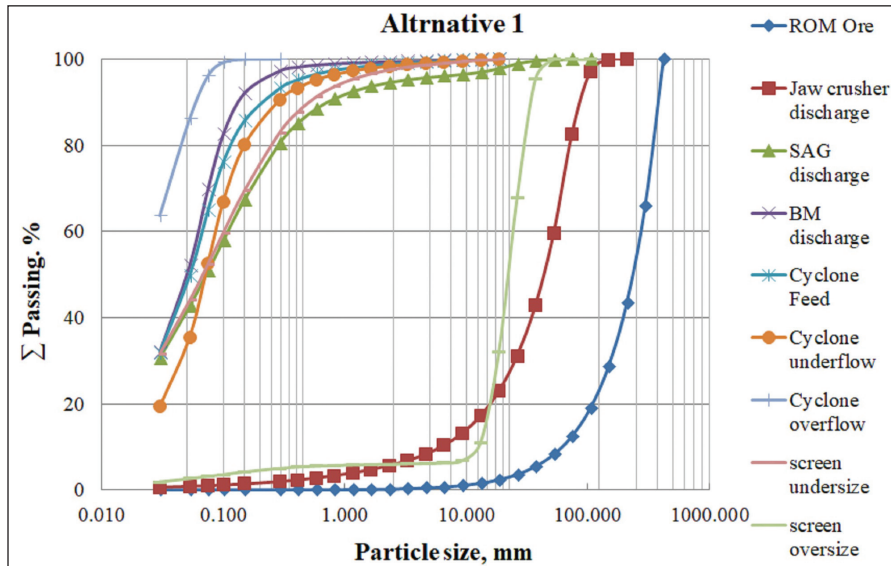

Figure 5- Simulated Size Distributions of the Streams for Alternative Circuit 1.

In this alternative, a jaw crusher which has feed opening of 1300 mm length and 1100 mm width will be used. The motor should be 160 kW. The dimension of the vibrating screen to be used for SAG Mill discharge will be 1×1.5 m which has 13 mm square opening and 54% open area. The diameter of hydrocyclone will be 375 mm. 6 operating and 2 spare cyclones will be used in the cluster. The volume of pump sump will be 25 m³.

The ball charge distribution in SAG mill will be; 125 mm (30%), 90 mm (30%), 60 mm (30%), 40 mm (5%) and 30 mm (5%) with a total of 36 ton. In the ball mill, too, the largest ball diameter will be 30 mm and combination with weight is 51% (30 mm) and 49% (20 mm).

2.2.2. Open Circuit Coarse Ball Milling and Closed Circuit Fine Grinding Ball Milling

The total energy consumption of this alternative will be 3702 kW. In this alternative ROM ore will be crushed by a jaw crusher. The crushed material will be fed to a vibrating screen having 50 mm square aperture. Screen oversize will be crushed by a toothed roll crusher and crushed material will be fed to the same screen. Screen undersize will be stockpiled. A ball mill having 3,8 m inside diameter and 5 m inside length will be used. This mill will work with 35% volumetric total load and 1300 kW mill power. The ball mill discharge will be fed to the cyclone feed sump. 8×375 mm cyclones will be used to separate fine material. The cyclone underflow will be fed to

a secondary ball mill having 4,4 m inside diameter and 6 m inside length. This mill will work with 35% volumetric total load and 1875 kW mill power. Ball mill discharge will be fed to the cyclone feed sump. The cyclone overflow will be the final product. The flowsheet for Alternative 2 is given in figure 6 and the simulated size distribution of the streams around the circuit is shown in figure 7.

A jaw crusher which has feed opening of 1300 mm length and 1100 mm width will be used. The motor should be 160 kW. A toothed roll crusher will be used as a secondary crusher. The dimension of the vibrating screen to be used in crushing circuit will be 2,4×6 m which has 50 mm square opening and 71% open area. The diameter of hydrocyclone will be 375 mm. 6 operating and 2 spare cyclones will be used in the cluster. The volume of pump sump is 25 m³.

2.2.3. Closed Circuit Coarse Ball Milling and Closed Circuit Fine Grinding Ball Milling

The total energy consumption of this alternative will be 3630 kW. This alternative is the same as Alternative 2 in terms of equipment dimensions.

There will be a spiral classifier, with 3 kW power, to operate the primary ball mill as a closed circuit. Primary ball mill discharge will be fed to the spiral classifier. The spiral classifier will have 9 m length and 1.3 m helix diameter. The spiral coarse product will be fed to the primary ball mill while fine product will be sent to the cyclone feed sump. 8×375 mm cyclones

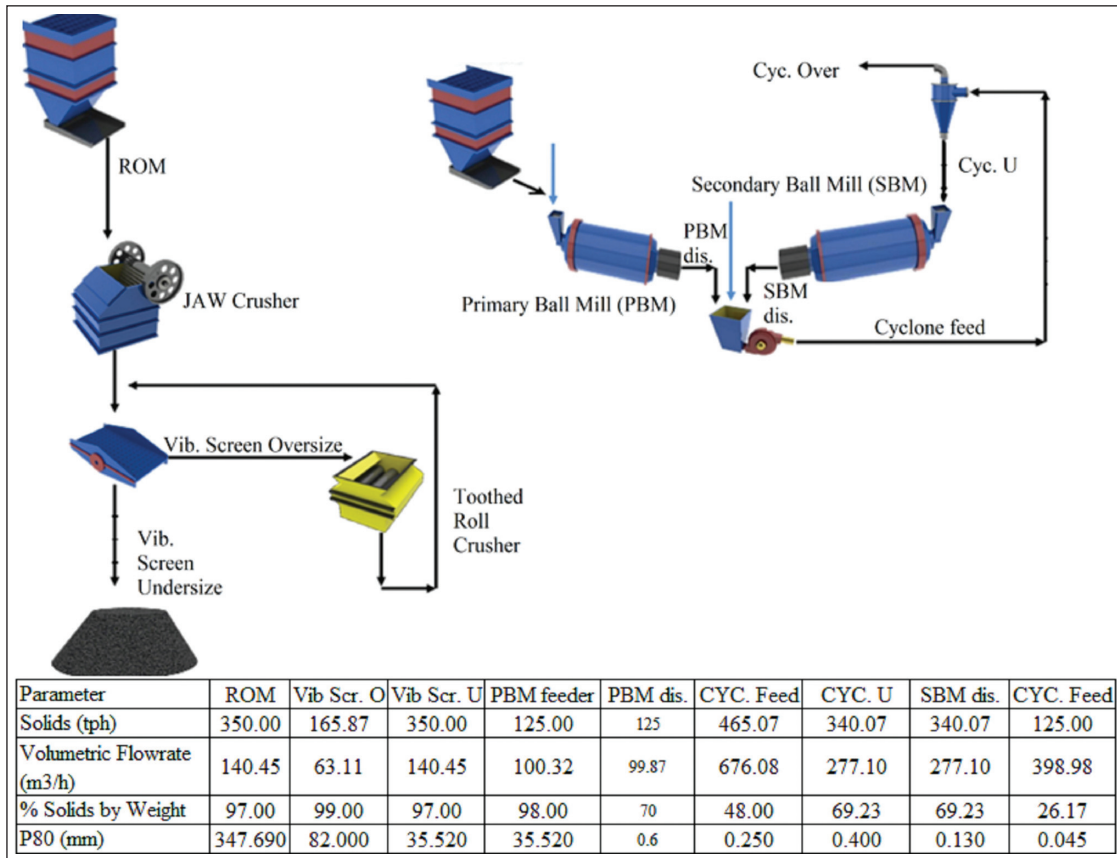

Figure 6- Simplified Flowsheet and Mass Balance of Alternative Circuit 2.

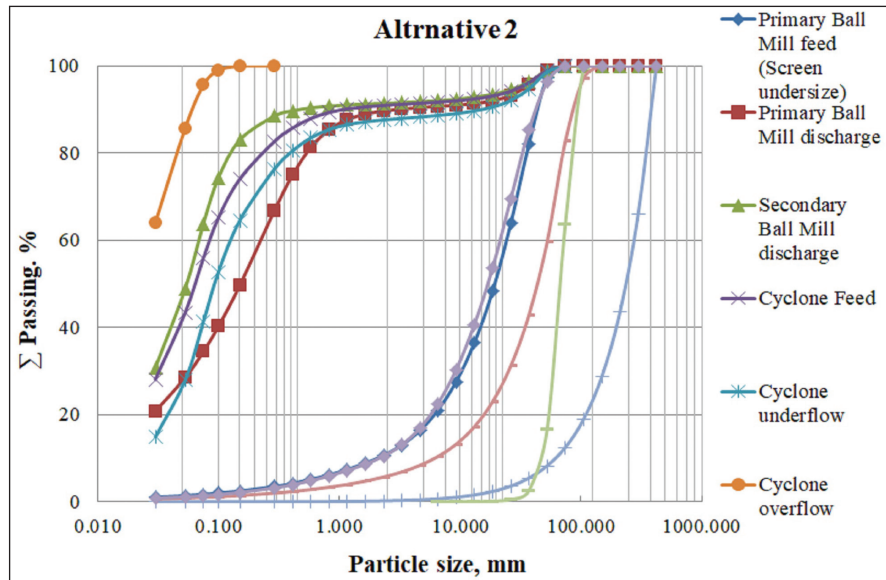

Figure 7- Simulated Size Distributions of the Streams for Alternative Circuit 2.

will be used to separate fine material. The cyclone underflow will be fed to a secondary ball mill having 4.4 m inside diameter and 6 m inside length. Ball mill discharge will be fed to the cyclone feed sump. The cyclone overflow will be the final product.

The flowsheet for Alternative 3 is given in figure 8 and the simulated size distribution of the streams around the circuit is shown in figure 9.

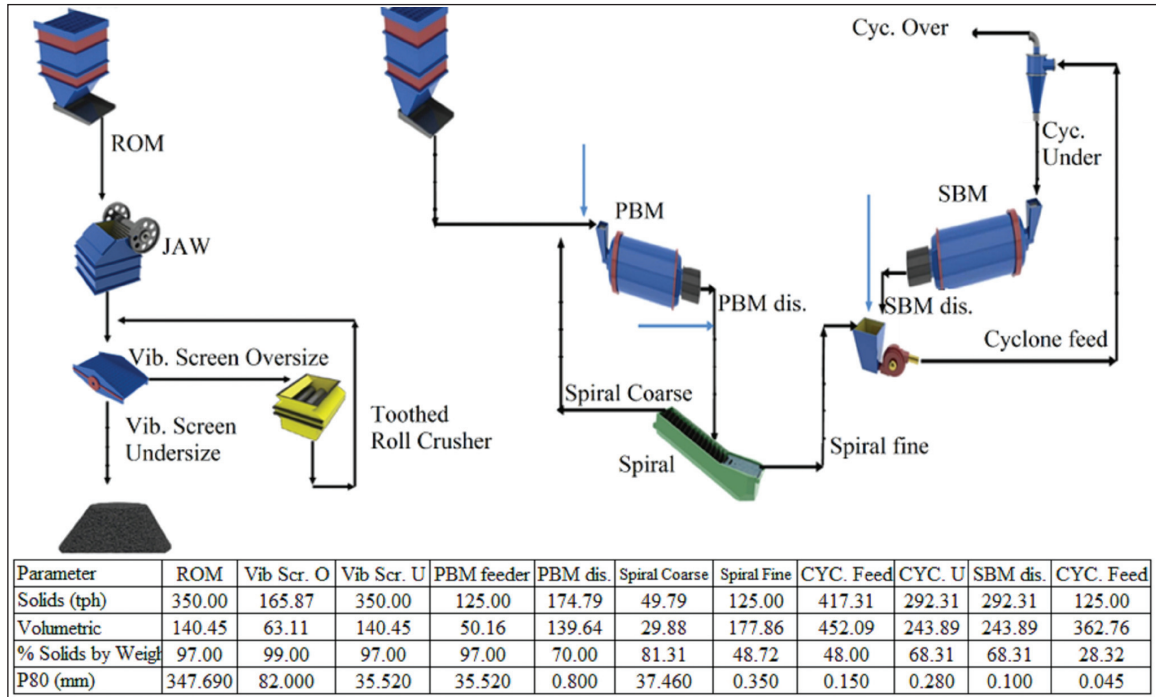

Figure 8- Simplified Flowsheet and Mass Balance of Alternative Circuit 3.

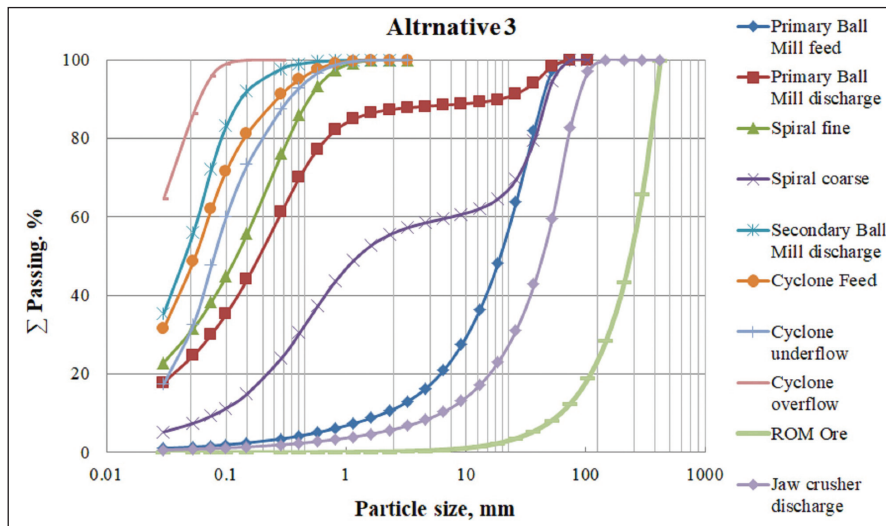

Figure 9- Simulated Size Distributions of the Streams for Alternative Circuit 3.

3. Results and Suggestions

The resulted data from the grinding tests (A , b , t_a , W_i) were used for ore characterization. According to the measured parameters ($A = 59,11$, $b = 2,41$, $t_a = 1,70$, $W_i = 9,20$ kWh/t) and the table 5 the ore is a relatively soft. For this reason, the use of the SAG mill is impractical and needs further investigation. Furthermore, with this result, it has also been shown that the ball mill can be more useful and can break down the ore to the required size (d_{80} of the hydrocyclone overflow (leaching tank feed) = $45 \mu\text{m}$). Therefore, the general structure of the grinding circuit is strongly influenced by the results of the grinding tests, and the selection or rejection of each equipment depends on the measured values of these tests.

By knowing the importance of the grinding parameters on the type of equipment and grinding circuit structure, simulation operations were performed using laboratory data (A , b , t_a , W_i), operating constraints (plant capacity = 125 tph, $d_{80} = 45 \mu\text{m}$ and ability to work for clayey minerals), JKSimMet software and existing mathematical models for different types of crushers, mills and separators. By completing the simulation process, three different alternatives for the grinding circuit of the considered ore were predicted. These grindability and simulation studies showed that:

- 1) The SAG mill alternative will be very dependent on the size distribution of ROM ore as well as jaw crusher discharge. Large particles have higher rates of abrasion and therefore there may be competency issues during operation. This may reduce the mill capacity and also cause discontinuity in the operation. Alternatively, separate coarse and fine ROM blends can be prepared. However, this complicates operation and the advantage of using a SAG mill would be diminished.
- 2) AG/SAG mill design usually requires several sets of samples for material characterization to avoid fluctuations, as possible as, in performance throughout the life of the mine.
- 3) Since the presence of clay is known in the ore, conventional fine crushing by cone crusher is avoided. Therefore, for both Alternative 2 and 3 toothed roll crusher is suggested as a secondary crusher. In this case mill feed will have $F_{80} = 35.5$ mm which is a coarser feed for ball mill.

- 4) Simulation studies showed that there will be remaining coarse particles in primary ball mill discharge for Alternative 2. This may cause mechanical problems in mill discharge trommel and large particle reporting to pump sump could cause severe wear and mechanical problems in the cyclone feed pump, especially if the grindability of the feed worsens. Those coarse particles will not be broken in the secondary ball mill where finer balls are used and there will be accumulated in the mill and this may cause the mill to be shut down and stopped.
- 5) The simulation results show that the specific energy consumption of these three alternatives are 31.82, 29.62 and 29.04 kWh/t respectively.
- 6) It is easier to control of ball mills due to the non sensitivity to the feed hardness and low sensitivity to the changes in mineral properties.
- 7) These three alternatives have been compared and evaluated with each other in terms of specific energy consumption (kWh/t), sensitivity to operational variables and the ability to process clayey minerals. The optimal circuit must have the capability to process clayey minerals and must have the lowest specific energy consumption and the least sensitivity to operational variables.

By considering all these factors, the Alternative 3 is selected and suggested for an efficient grinding circuit.

Also, in the future, by using of a set of simulation study's results, validated laboratory data, development of more precise models and development of high-throughput computers, it will be possible to simulate complex ore processing circuits and provide high decision-making power to the investors and miners.

Acknowledgements

This study was carried out within the scope of Comminution Circuit Design for Iranian Gold Co. project at Hacettepe University in Turkey. Here, I would like to acknowledge to the Mining Engineering department of Hacettepe University for providing experimental facilities for conducting the research works. The authors also thanks to anonymous reviewers and Editor for their opinions, comments and enlightening discussions due to improve the paper.

References

- Andersen, J.S. 1989. Development of a Cone Crusher Model. M.Eng.Sc Thesis, University of Queensland.
- Arbiter, N., Harris, C.C., Stamboltzis, G.A. 1969. Single fracture of brittle spheres. *Trans. Soc. Min. Eng., AIME* 244, 118–130.
- Austin, L. G., Klimpel, R. R., Luckie, P. T. 1984. *Process Engineering of Size Reduction: Ball Milling*. Society of Mining Engineers of the American Institute of Mining, Metallurgical and Petroleum Engineers (AIME) Inc, ISBN 0895204215, New York, 556 pp.
- Awachie, S.F.A. 1983. Development of crusher models using laboratory breakage data, PhD Thesis, University of Queensland.
- Banks, J., Carson, J., Nelson, B., Nicol, D. 2001. *Discrete-Event System Simulation*. Prentice Hall. p. 3. ISBN 0-13-088702-1.
- Bond, F.C. 1952. The third theory of comminution. *Trans AIME* 193, 484–494.
- Bond, F.C. 1961. Crushing and grinding calculations, *British Chemical Engineering*, 6, 6, pp: 378 - 385.
- Broadbent, S.R., Callcott, T.G. 1956. A matrix analysis of processes involving particulate assemblies. *Phil. Trans Royal Soc. London, Ser. A* 249, 99–123.
- Daniel, M.J. 2002. HPGR model verification and scale-up. M.Sc Thesis, School of Engineering, University of Queensland, Brisbane, Australia.
- Daniel M.J., Morrell S. 2004. HPGR Model Verification and Scale-up. *Minerals Engineering*, 17, 1149-1161.
- Deister, R.J. 1987. How to determine the Bond work index using lab. ball mill grindability tests. *Engng. Min. J.*, 188, 42.
- Delboni, H., Marco A., Rosa, N., Mauricio, G., Bergerman, Rinaldo P. Nardi. 2006. Optimisation of the Sossego Sag Mill. SAG 2006: SAG Mill Circuit. *Int. Conf. on Autogenous and Semi autogenous Grinding Technology*, 1: 39-50.
- Dunne, R., Morrell, S., Lane, G., Valery, W., Hart, S. 2001. Design of the 40 foot diameter sag mill installed at the Cadia gold copper mine. SAG 2001, mining and mineral process engineering University of British Columbia, Vancouver, Canada.
- Epstein, B. 1947. The Material Description of Certain Breakage Mechanisms Leading to the Logarithmic-Normal Distribution, *J. Franklin Inst.*, 244, 471-477.
- Epstein, B. 1948. Logarithmic-normal distributions in the breakage of solids. *Ind. Eng. Chem.*, 40, 2289–2291.
- Ergün, L., Gülsoy, O., Can, M., Benzer, H. 2005 (June 09-12). Optimization of Çayeli (Çbi) Grinding Circuit by Modelling and Simulation. The 19th International Mining Congress and Fair of Turkey (IMCET2005), İzmir, Turkey.
- Gardner, R.P., Austin, L.G. 1962. A Chemical Engineering Treatment of Batch Grinding. *Proceedings, First European Symp. Zerkernern*. Edited by H. Rumpf and D. Behrens, Verlag Chemie, Weinheim, 217-247.
- Genç, O., Ergün, L., Benzer, H. 2004. Single particle breakage characterization of materials by drop weight testing. *XLI Annual Symposium Physicochemical Problems of Mineral Processing and IX International Mineral Processing Meeting*, Poland 38, 241–255.
- Genç, O., Benzer, H. 2008. Analysis of single particle breakage characteristics of cement clinker and cement additives by drop-weight technique. *The Journal of the Chamber of Mining Engineers of Turkey* (47) (in Turkish), 13–26.
- Gharehgheshlagh, H. H. 2016. Kinetic grinding test approach to estimate the ball mill work index. *Physicochemical Problems of Mineral Processing*, 52(1), 342-352. <https://doi.org/10.5277/ppmp160129>.
- Gray, J., Rumpe, B. 2016. Models in simulation. *Softw Syst Model*, 15, 605–607.
- Gross, J. 1938. Crushing and grinding. *US Bureau of Mines Bulletin* 402, 1–148.
- Hart, S., Valery, W., Clements, B., Reed, M., Song, M., Dunne, R. 2001. Optimisation of the Cadia Hill Sag mill circuit. SAG 2001. Mining and mineral process engineering university of British Columbia, Vancouver, Canada.
- Herbst, J. A., Fuerstenau, D. W. 1980. Scale-Up Procedure for Continuous Grinding Mill Design Using Population Balance Models. *International Journal of Mineral Processing*, 7, 1-31.
- Hosseinzadeh Gharehgheshlagh, H. 2014. An Investigation on Scale - Up of Ball Mills (in Turkish). PHD thesis, Hacettepe University, Mining Engineering Department, 292 pp. Ankara (unpublished), Turkey.
- Hosseinzadeh Gharehgheshlagh H., Ergun, L., Chehrehgani, S. 2017. Investigation of the laboratory conditions effects on the prediction accuracy of size distribution of industrial ball mill discharge by using of perfect mixing model; case study: Ozdogu copper-molybdenum plant, *Physicochemical Problems of Mineral Processing*, 53(2), 1175–1187.

- JK Bond Ball Mill Index Test, https://jktech.com.au/sites/default/files/brochures/LabServices_BondBallMill.pdf.
- JK Drop Weight Test, https://jktech.com.au/sites/default/files/brochures/LabServices_DWTest_Indetail.pdf
- Kelly, E.G. 1991. The Evaluation of Separation Efficiency. In *Evaluation and Optimisation of Metallurgical Performance*. ed. Malhotra, Klimpel, Mular, SME Inc, Littleton, 239-252.
- Kelly, E.G., Spottiswood, D.J. 1982. Introduction to mineral processing. J. Wiley, Chapters 3 and 25.
- Kelsall, D.F., Reid KJ. 1969. Symposium on size reduction, Chemical Engineering Association, Sydney University.
- King, R.P., Schneider, C.L., King, E.A. 2012. *Modeling and Simulation of Mineral Processing Systems*. SME, ISBN-13: 978-0-87335-345-8, Colorado, USA.
- Koch, P.H. 2017. Particle Generation for Geometallurgical Process Modeling. Licentiate thesis, Luleå University of Technology, Division of Minerals and Metallurgical Engineering (MiMeR), Department of Civil, Environmental and Natural Resources Engineering, 126 pp. Luleå, Sweden.
- Leung, K. 1987. An Energy-based Ore Specific Model for Autogeneous and Semi-autogeneous Grinding. PhD Thesis, JKMRRC, University of Queensland.
- Leung, K., Morrison, R.D., Whiten, W.J. 1987. An energy based ore specific model for autogenous and semi-autogenous grinding. *Copper 87*. Chilean Institute of Mining Engineers, Santiago, Chile.
- Levin, J. 1989. Observations on the Bond standard grindability test, and a proposal for a standard grindability test for fine materials. *J.S. Afr. Inst. Min. Metall.*, 89, 13.
- Liang, G., Wei, D., Xu, X., Xia, X., Li, Y. 2016. Study on the Selection of Comminution Circuits for a Magnetite Ore in Eastern Hebei, China. *Minerals*, 6(2), 39; <https://doi.org/10.3390/min6020039>.
- Lynch, A. J. 1977. Mineral crushing and grinding circuits: their simulation, optimisation, design, and control. New York: Elsevier Scientific.
- Lynch, A. J., Rao, T. C. 1975. Modelling and scale-up of hydrocyclones classifiers. In *XI International Mineral Processing Congress*, Cagliari, 245-269.
- Man, Y.T. 2001. Model-Based Procedure For Scale-up of Wet, Overflow Ball Mills Part-2: Validation and Discussion. *Minerals Engineering*, Volume 14, No.10, 1259-1265.
- Maruf Hasan, Md. 2016. Process Modelling of Gravity Induced Stirred Mills. PHD thesis, University of Queensland, JKMRRC, 211 pp. Brisbane, Australia.
- Morrell, S. 1992 (January-April). Prediction of Grinding-Mill Power. *Transaction of Institute of Mining and Metallurgy, Section C: Mineral Processing and Extractive Metallurgy*. 101, 25-32.
- Morrell, S. 1993. The prediction of power draw in wet tumbling mills. PhD Thesis, JKMRRC, University of Queensland, Brisbane.
- Morrell, S. 1996 (January-April). Power Draw of Wet Tumbling Mills and Its Relationship to Charge Dynamics, Part 1: A Continuum Approach to Mathematical Modelling of Mill Power Draw. *Transaction of Institute of Mining and Metallurgy, Section C: Mineral Processing and Extractive Metallurgy*, 105, 43-53.
- Morrell, S. 1996 (January-April). Power Draw of Wet Tumbling Mills and Its Relationship to Charge Dynamics, Part 2: An Empirical Approach to Modelling of Mill Power Draw. *Transaction of Institute of Mining and Metallurgy, Section C: Mineral Processing and Extractive Metallurgy*, 105, 54-62.
- Morrell, S., Morrison, R. 1989. Ore charge, ball load and material flow effects on an energy based SAG mill model. *SAG Milling Conference*, Murdoch University WA.
- Morrell, S., Napier-Munn, T.J., Andersen, J. 1992. The prediction of power draw in comminution machines. *Comminution-Theory and Practice*, K. Kawatra (ed), SME, Chapter 17, pp. 2 35-247.
- Morrell, S., Finch, W.M., Kojovic, T., Delboni Jr., H. 1996. Modelling and simulation of large diameter autogeneous and semi-autogeneous mills. *Int. J. Miner. Process*, 44-45, 289-300.
- Morrell, S., Lim, W., Shi, F., Tondo, L. 1997. Modelling of the HPGR Crusher. *Comminution Practices*, ed. Kawatra, K.S., Society for Mining, Metallurgy, and Exploration, Inc. (SME), Chapter 17, pp. 117-126.
- Mular, A., Halbe, D., Barratt, D. 2002. *Mineral Processing Plant Design, Practice, and Control*. SME, ISBN 087335-223-8, Colorado, USA.
- Munoz, A., Alvarez, L., Colacioppo, J., Valery, W. 2008. Process Integration and Optimisation at Freeport - McMoran Candelaria Mine, Copiapó, Chile, *Proceedings of the V International Mineral Processing Seminar, PROCEMIN 2008*, Santiago, Chile, 303-315.
- Nageswararao, K. 1978. Further developments in the modeling and scale-up of industrial hydrocyclones. PHD thesis, JKMRRC, University of Queensland, Brisbane, Australia.

- Napier-Munn, T.J., Morrell, S., Morrison, R.D., Kolovic, T. 1996. Mineral Comminution Circuits: Their Operation and Optimisation. JKMRCC, University of Queensland, Brisbane.
- Narayanan, S.S. 1985. Development of a Laboratory Single Particle Breakage Technique and its Application to Ball Mill Modelling and Scale-up. Ph.D. Thesis, University of Queensland.
- Narayanan, S.S., Whiten W.J. 1983 (June). Breakage Characteristics for Ores for Ball Mill Modelling. *Australias Inst Min Metall*, 286, 31-39.
- Nikkhah, K., Anderson, C. 2001 (Feb. 26-28). Role of simulation software in design and operation of metallurgical plants: a case study. SME Annual Meeting, Denver, Colorado.
- Özer, C., Whiten, W.J. 2012. A multi-component appearance function for the breakage of coal. *International Journal of Mineral Processing*, 104-105, 37-44.
- Palaniandy, S. 2017. Extending the application of JKFCB for gravity induced stirred mills feed ore characterization. *Minerals Engineering* 101, 1-9.
- Pellegrini Rosario, P. 2010. Comminution Circuit Design and Simulation for the Development of a Novel High Pressure Grinding Roll Circuit. PHD thesis, University of British Columbia, Faculty of Mining Engineering, 175 pp. Vancouver, Canada.
- Piret, E.L. 1953. Fundamental aspects of grinding. *Chemical Engineering Progress*, 49, 56-63.
- Robinson, S. 1997. Simulation Model Verification and Validation: Increasing The Users' Confidence. Proceedings of the 1997 Winter Simulation Conference, Atlanta, USA.
- Rosin, P., Rammler, E. 1933. The laws governing the fineness of powdered coal. *J. Inst. Fuel*, 7, 29-36.
- Schwarz, S., Richardson, J. M. 2013 (Feb. 24 - 27). Modeling and Simulation of Mineral Processing Circuits Using Jksimmet and Jksimfloat. SME annual meeting, Denver Co.
- Shi, F., Kojovic, T., Brennan, M. 2015. Modelling of vertical spindle mills. Part 1: Sub-models for comminution and classification. *Fuel* 143, 595-601.
- Sokolowski, J.A., Banks, C.M. 2009. Principles of Modeling and Simulation. Hoboken, NJ: Wiley. p. 6. ISBN 978-0-470-28943-3.
- Sutherland, K.L. 1948. Physical chemistry of froth flotation XI Kinetics of the flotation process. *J. Phys. Colloid. Chem.* 52, 394-425.
- Tavares, L.M. 1999. Energy absorbed in breakage of single particles in drop-weight testing. *Minerals Engineering*, 12 (1), 43-50.
- Tavares, L., Delboni, H. 2016. Modelling and Simulation of the Santa Rita Mine Milling Circuit, REM (*Revista Escola de Minas*), Ouro Preto, 69(2), 207-211.
- Tondo L. 1996. Modelling of HPGR crushers. M. Eng Science Thesis, University of Queensland.
- Wendelin Wikedzi, A. 2018. Optimization and Performance of Grinding Circuits: The Case of Buzwagi Gold Mine (BGM). PHD thesis, Technische Universität Bergakademie, Faculty of Mechanical, Process and Energy Engineering. 208 pp. Freiberg, Germany.
- Wenzheng, L. 1991. Comminution for large concentrator. *Transactions of NfSoc*, vol. 1, no.1.
- Whiten, W.J. 1971. Proceeding, Symposium on Automatic Control Systems Mineral Processing Plants, AusIMM, Southern Queensland branch, 129-148.
- Whiten, W. J. 1972. The simulation of crushing plants with models developed using multiple spline regression. In 10th International Symposium on the Application of Computer Methods in the Mineral Industry, Johannesburg, 317-323.
- Whiten, W.J. 1974. A matrix theory of comminution machines. *Chem. Eng. Sci.* No. 29, 585-599.
- Whiten, W.J., 1976. Ball mill simulation using small calculators, *Proc. Australias. Inst. Min. Metall.*, 258, 47 - 53.
- Whiten, W.J. 1984. Models and control techniques for crushing plants, *Control* 84, *Minl./ Metall. Process (Am.Inst.Min.Engrs. Annual Meet., Los Angeles, USA, February)*, 217-225. Queensland branch, 129-148.
- Wills, B.A., Napier-Munn, T. 2011. Will's mineral processing technology: An introduction to the practical aspects of ore treatment and mineral recovery. Seventh edition, Elsevier Ltd.
- Yoshioka, N., Hotta, Y. 1955. Liquid cyclone as a hydraulic classifier. *Chem. Eng. Japan* 19, 632-640.
- Zuo, W. 2015. A study of the applications and modelling of high voltage pulse comminution for mineral ores. PHD thesis, University of Queensland, JKMRCC. 206pp. Brisbane, Australia.